

Concepts of Condensed Matter Physics

July 23, 2018

Contents

1	Introduction - an Overview	5
2	Spin Models	5
2.1	Model Building	5
2.1.1	First Quantization	5
2.1.2	Second Quantization	5
2.1.3	Effective interactions: Direct (Hartree) Exchange (Fock) and Cooper (Pairing) channels	7
2.1.4	Definition of Heisenberg's Model	10
3	Tight Binding and the Hubbard Model (Tutorial)	11
3.1	Tight binding method	11
3.2	The Hubbard Model	13
4	Mean Field Solution of the Heisenberg Model – Spontaneous Symmetry Breaking	18
4.1	General Mean Field approximation	18
4.1.1	Mean Field solution of the Heisenberg model	18
4.2	Goldstone Modes (Magnons)	19
4.2.1	Holstein-Primakoff	21
4.2.2	Absence of LRO (Long Range Order) in 1D and 2D systems with broken continuous symmetries - Mermin-Wagner Theorem	22
4.2.3	Average magnetization	22
5	The Mermin-Wagner theorem (Tutorial)	23
6	Path integral formulation and the Hubbard-Stratonovich transformation (Tutorial)	26
6.1	Introduction	26
6.2	Coherent state path integrals	26
6.2.1	Bosonic coherent states	26
6.2.2	Fermionic coherent states	27
6.2.3	Derivation of the path integral	27
6.3	The Hubbard-Stratonovich transformation	29

7 Superfluid (Based on Ref. [1])	31
7.1 Symmetry (Global Gauge symmetry)	31
7.2 The Bose-Einstein condensation	31
7.3 Weakly Interacting Bose Gas	34
7.3.1 Mean Field Solution	34
7.3.2 Goldstone Modes	34
7.4 Superfluidity	36
7.5 Landau's Argument	37
7.6 Various Consequences	37
7.6.1 Quantization of Circulation	37
7.6.2 Irrotational flow	38
7.6.3 Vortices	38
8 Superconductivity	39
8.1 Basic Model and Mean field solution	39
8.2 The Anderson -Higgs Mechanism	39
8.2.1 Local gauge symmetry	39
8.3 London Equations (Phenomenology of Superconductivity)	41
8.4 Vortices in Superconductor	42
8.4.1 The magnetic field penetration depth	42
8.4.2 The Coherence Length	43
8.4.3 Two types of superconductors	44
8.4.4 Vortexes in Type II superconductor	45
9 The BCS theory of superconductivity (Tutorial)	48
9.1 Preliminaries	48
9.1.1 Attractive interaction for fermions	48
9.1.2 Formation of bound states: Cooper pairs	48
9.2 BCS theory of superconductivity	50
9.3 Deriving the Ginzburg-Landau theory for superconductivity	52
10 Supplementary topics in superconductivity (Tutorial)	55
10.1 Phonon mediated attractive interaction for electrons	55
10.2 RG equation for the Cooper channel	56
11 The 2D XY Model: The Berezinskii-Kosterlitz-Thouless transition	60
11.1 Vortices in the XY model	61
11.2 Kosterlitz-Thouless Argument	63
11.3 Describing vortices as a Coulomb gas	63
11.3.1 RG Approach	64

11.3.2	The order of the KTB phase transition	69
11.4	Coulomb gas and the Sine-Gordon mapping (Momentum RG)	70
11.4.1	Mapping between Coulomb Gas and the Sine Gordon model	70
11.4.2	(Momentum shell) Renormalization group of the sine Gordon Model	71
11.4.2.1	First order term	71
11.4.2.1.1	Integrating out the fast variables – thinning the degrees of freedom	71
11.4.2.1.2	Rescaling	72
11.4.2.1.3	Field rescaling	72
11.4.2.2	Second order term	73
11.4.2.2.1	Integrating out the fast variables	73
11.4.2.2.2	Rescaling	74
11.4.2.2.3	Field Rescaling	74
12	The Quantum Hall Effect – This chapter is still under construction	75
12.1	Classical Hall Effect	75
12.2	Quantum Hall effect	77
12.2.1	Experimental observations	77
12.3	Basic explanation of the quantization effect	78
12.4	Additional conclusions, based on the existence of a gap in the system	80
12.4.1	Edge states	80
12.4.2	Fractional charges (Laughlin)	81
12.4.3	Quantization of Hall conductance in the integer case	82
12.4.4	Quantization of the Hall conductance and Chern numbers using Linear response	82
13	Introduction to Graphene (Tutorial)	87
13.1	Tight binding models	87
13.2	Graphene	87
13.3	Emergent Dirac physics	89
14	Graphene – Quantum Hall effect without constant magnetic field	92
14.1	Tight-binding approximation for Graphene	92
14.2	Band structure - Dirac dispersion in quasi momentum	92
14.3	The Haldane model	93
14.4	Chern number in Haldane’s model and Obstruction of Stokes’ theorem	95
14.4.1	Obstruction of Stokes’ theorem	95
14.4.2	Chern number in Haldane’s model	97
14.4.3	Chern number near a Dirac point	97
14.4.4	Explicit solution of edge mode in a massive Dirac spectrum	98
14.5	Topological insulators and Spin-orbit coupling, Kane and Mele Model (2005))	100

References

- [1] Alexander Altland and Ben Simons. *Condensed Matetr Field Theory*. Cambridge, University Press, second edition, 2010. [\(document\)](#), [7](#)
- [2] Neil.W. Ashcroft and N. David Mermin. *Solid State Physics*. CBS publishing Asia Ltd., Philadelphia, 1987. [8.2.1](#)
- [3] Assa Auerbach. *Interacting Electrons and Quantum Magnetism*. Springer-Verlag, 1994. [2](#)
- [4] P. G. De-Gennes. *Superconductivity of Metals and Alloys*. Benjamin, New-York, 1966. [8.4.4](#)
- [5] M. O. Goerbig. Quantum Hall Effects. *ArXiv e-prints*, September 2009. [12](#)
- [6] Alexander O. Gogolin, Alexander A. Nersesyan, and Alexei M. Tsvelik. *Bosonization and Strongly Correlated Systems*. CAMBRIDGE UNIVERSITY PRESS, 1998. [11.4.2](#)
- [7] N. Nagaosa and S. Heusler. *Quantum Field Theory in Condensed Matter Physics*. Theoretical and Mathematical Physics. Springer, 2010. [8.4.1](#)

1 Introduction - an Overview

2 Spin Models

References: Chapters 1 and 2 in Ref. [3].

2.1 Model Building

2.1.1 First Quantization

We consider Bloch wave-functions which are the single electron solutions of the Hamiltonian

$$H^0 \phi_{ks} = \left[\frac{-\hbar^2}{2m} \nabla^2 + V^{\text{ion}}(x) \right] \phi_{ks}(x) = \varepsilon_k \phi_{ks}(x),$$

from which we can define a many electron Hamiltonian:

$$\mathcal{H}^0 = \sum_{i=1}^{N_e} H^0(\nabla_i, x_i).$$

The Hamiltonian \mathcal{H}^0 has eigenfunctions and eigenvalues

$$\Psi_K^{\text{Fock}}(x_{1,s_1}, x_{2,s_2} \dots x_{N_e, s_{N_e}}) = \det_{ij} [\phi_{k_i s_i}(x_i)] , E_K = \sum_{i=1}^{N_e} \varepsilon_{k_i},$$

where the ε_k are bounded by the Fermi energy E_F .

The Hamiltonian \mathcal{H}^0 describes non-interacting electrons. We add an interaction term and consider

$$H = \mathcal{H}^0 + \frac{1}{2} \sum_{i,j} V^{\text{el-el}}(x_i, x_j),$$

which we can write

$$H = \sum_{i=1}^{N_e} (H^0 + V^{\text{eff}}[x_i, \rho]) + \frac{1}{2} \sum_{ij} \tilde{V}(x_i, x_j),$$

where V^{eff} is obtained by in a mean field sense by “freezing” one x_i and summing over all other x_j in $V^{\text{el-el}}$ and

$$\tilde{V}(x_i, x_j) = V^{\text{el-el}}(x_i, x_j) - (V^{\text{eff}}(x_i) + V^{\text{eff}}(x_j)) / N_e.$$

Taking the residual interactions $\tilde{V}(x_i, x_j)$ instead of the of $V^{\text{el-el}}(x_i, x_j)$ represents screening. If we neglect \tilde{V} we obtain an effective non-interacting theory of Fermions. However, the theory has, compared to \mathcal{H}^0 , new effective parameters that may be determined, for example, in a self-consistent way. We also assume dynamics which is slower than the plasma frequency. The single electron approximation has been very successful in predicting various properties of many materials. However, to describe phenomena such as magnetism and superconductivity, one has to go beyond that and consider the residual interactions.

2.1.2 Second Quantization

We would like now to present the Many body Hamiltonian using the second quantization formalism. For that we define a creation operator $\hat{\psi}_s^\dagger(\vec{r})$. When acting on the vacuum state (a state with zero particles that we denote $|0\rangle$) gives

$$\langle \vec{y}, \sigma | \hat{\psi}_s^\dagger(\vec{x}) | 0 \rangle = \delta_{s\sigma} \delta(\vec{x} - \vec{y}).$$

(Anti)Commutation relations of ψ

We can choose a basis of the Hilbert space $\{\phi_\alpha\}$ and write

$$\hat{\psi}_s^\dagger(\vec{x}) = \sum_\alpha \phi_{\alpha s}^*(\vec{x}) c_{\alpha s}^\dagger \quad (1)$$

$$\begin{aligned} \left\{ \hat{\psi}_s^\dagger(\vec{x}), \hat{\psi}_\sigma(\vec{y}) \right\} &= \sum_{\alpha\beta} \phi_{\alpha s}^*(\vec{x}) \phi_{\beta\sigma}(\vec{y}) \{c_{\alpha s}^\dagger, c_{\beta\sigma}\} = \sum_{\alpha\beta} \phi_{\alpha s}^*(\vec{x}) \phi_{\beta\sigma}(\vec{y}) \delta_{s\sigma} \delta_{\alpha\beta} \\ &= \sum_\alpha \phi_{\alpha s}^*(\vec{x}) \phi_{\alpha\sigma}(\vec{y}) \delta_{s\sigma} \underbrace{\quad}_{\{\phi\} \text{ complete}} \delta_{s\sigma} \delta(\vec{x} - \vec{y}). \end{aligned} \quad (2)$$

The Hamiltonian is now

$$\begin{aligned} \hat{H}^0 &= \sum_s \int d^3x \hat{\psi}_s^\dagger(\vec{x}) \left[\frac{-\hbar^2}{2m} \nabla^2 + V^{\text{ion}}(\vec{x}) + V^{\text{eff}}(\vec{x}) \right] \hat{\psi}_s(\vec{x}) \\ \hat{V} &= \frac{1}{2} \int d^3x d^3y \tilde{V}(\vec{x}, \vec{y}) [\hat{\rho}(\vec{x}) \hat{\rho}(\vec{y}) - \delta(\vec{x} - \vec{y}) \hat{\rho}(\vec{x})] \end{aligned} \quad (3)$$

where the second term is because we have no self-interaction. Since

$$\begin{aligned} \hat{\rho}(\vec{x}) &= \sum_s \hat{\psi}_s^\dagger(\vec{x}) \hat{\psi}_s(\vec{x}) \\ \hat{\rho}(\vec{x}) \hat{\rho}(\vec{y}) &= \sum_{s,\sigma} \hat{\psi}_s^\dagger(\vec{x}) \hat{\psi}_s(\vec{x}) \hat{\psi}_\sigma^\dagger(\vec{y}) \hat{\psi}_\sigma(\vec{y}) = - \sum_{s,\sigma} \hat{\psi}_s^\dagger(\vec{x}) \hat{\psi}_\sigma^\dagger(\vec{y}) \hat{\psi}_s(\vec{x}) \hat{\psi}_\sigma(\vec{y}) + \sum_s \hat{\psi}_s^\dagger(\vec{x}) \hat{\psi}_\sigma(\vec{y}) \delta(\vec{x} - \vec{y}) \delta_{s\sigma} \\ &= \sum_{s,\sigma} \hat{\psi}_s^\dagger(\vec{x}) \hat{\psi}_\sigma^\dagger(\vec{y}) \hat{\psi}_\sigma(\vec{y}) \hat{\psi}_s(\vec{x}) + \hat{\rho}(\vec{x}) \delta(\vec{x} - \vec{y}) \end{aligned}$$

setting this in Eq. (2) the second term cancels, giving us

$$\hat{V} = \frac{1}{2} \sum_{s\sigma} \int d^3x d^3y \tilde{V}(\vec{x}, \vec{y}) \hat{\psi}_s^\dagger(\vec{x}) \hat{\psi}_\sigma^\dagger(\vec{y}) \hat{\psi}_\sigma(\vec{y}) \hat{\psi}_s(\vec{x}). \quad (4)$$

The ability to neglect \tilde{V} determines whether we can use a Fermi liquid theory with effective parameters or we get more dramatic interaction effects. For a rough estimate of whether \tilde{V} is large or small we note that in materials with an outer electron in the s shell the electron wave-functions obey $\langle r \rangle \sim a$ where a is the lattice constant and $\langle r \rangle$ is the average distance of the electron from the nucleus. For outer electrons in the d, f levels however, $\langle r \rangle \ll a$.

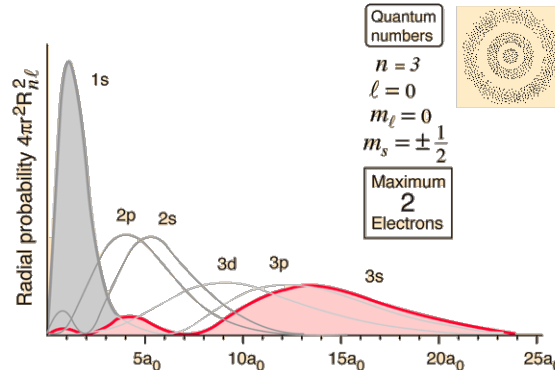

Figure 1: Wave function of hydrogen-like 3d and 3s orbital.

The typical kinetic energy of electrons is

$$E_F = \hbar v_F k_F, k_F \sim \frac{1}{a} \Rightarrow E_F \sim \frac{v_F}{a}$$

while the interaction is (with κ being the dielectric constant)

$$U = \frac{e^2}{\langle r \rangle \kappa}.$$

giving a ratio

$$r_s = \frac{U}{E_F} = \frac{e^2}{\kappa v_F} \frac{a}{\langle r \rangle}$$

Hence, in most cases, \tilde{V} will be more important in d, f materials (we know that in many metals $\frac{e^2}{\kappa v_F} \sim 1$).

The nearest neighbour interaction will be controlled by $\frac{e^2}{\kappa r_{ij}}/E_F$ however for $r \ll a$ the bands will be very narrow so that E_F is small and r_s is large.

2.1.3 Effective interactions: Direct (Hartree) Exchange (Fock) and Cooper (Pairing) channels

Metals

We now have to study the interaction term of Eq. (4). To appreciate the importance of different 'channels' of the interaction, it is useful to assume that the interaction between the electrons is due to Coulomb forces and to consider it in momentum space ($\hat{\psi}_s^\dagger(\vec{x}) = \frac{1}{\sqrt{V}} \sum_{\vec{p}} e^{-i\vec{p}\cdot\vec{x}} \hat{\psi}_{s\vec{p}}^\dagger$).

$$\hat{V} = \frac{1}{2} \sum_{\vec{p}_1, \vec{p}_2, \vec{p}_3, \vec{p}_4, s, \sigma} \hat{\psi}_{\vec{p}_4 s}^\dagger \hat{\psi}_{\vec{p}_2 \sigma}^\dagger \tilde{V}(\vec{p}_1 - \vec{p}_2) \hat{\psi}_{\vec{p}_1 \sigma} \hat{\psi}_{\vec{p}_3 s} \delta_{\vec{p}_1 + \vec{p}_3, \vec{p}_2 + \vec{p}_4}. \quad (5)$$

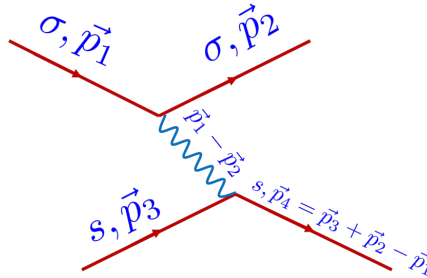

In principle, we can decouple this interaction using the Hubbard-Stratonovich in different ways. However, 'interesting' physics is usually generated by processes where one of the three unbound momenta entering the interaction vertex is small. Only these interaction processes have a chance to accumulate to an overall collective excitation of low energy. It may be instructive to imagine the situation geometrically: In the three dimensional cartesian space of free momentum coordinates $(\vec{k}_1, \vec{k}_2, \vec{k}_3)$, entering the vertex. There are three thin layers, where one of the momenta is small, $(\vec{q}, \vec{k}_2, \vec{k}_3)$, $(\vec{k}_1, \vec{q}, \vec{k}_3)$, and $(\vec{k}_1, \vec{k}_2, \vec{q})$, $|\vec{q}| \ll |\vec{k}_i| \approx p_F$ - (Notice that we did not take all the momenta to be small, because that would be in conflict with the condition that electrons have momenta close to the Fermi surface.) One will thus often chose to break down the full momentum summation to a restricted summation over the small-momentum sub-layers:

$$\hat{V} \approx \hat{V}_H + \hat{V}_F + \hat{V}_C$$

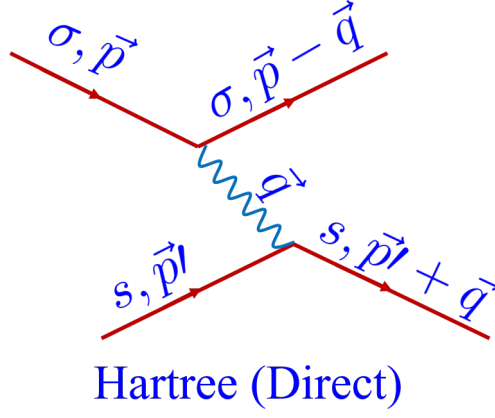

$$\hat{V}_H = \frac{1}{2} \sum_{\vec{p}_1, \vec{p}', \vec{q}, s, \sigma} \hat{\psi}_{\vec{p}'+\vec{q}, s}^\dagger \hat{\psi}_{\vec{p}-\vec{q}, \sigma}^\dagger \tilde{V}(\vec{q}) \hat{\psi}_{\vec{p}, \sigma} \hat{\psi}_{\vec{p}', s}. \quad (6)$$

$$\hat{V}_F = \frac{1}{2} \sum_{\vec{p}_1, \vec{p}', \vec{q}, s, \sigma} \hat{\psi}_{\vec{p}', s}^\dagger \hat{\psi}_{\vec{p}'+\vec{q}, \sigma}^\dagger \tilde{V}(\vec{p} - \vec{p}') \hat{\psi}_{\vec{p}+\vec{q}, \sigma} \hat{\psi}_{\vec{p}, s}. \quad (7)$$

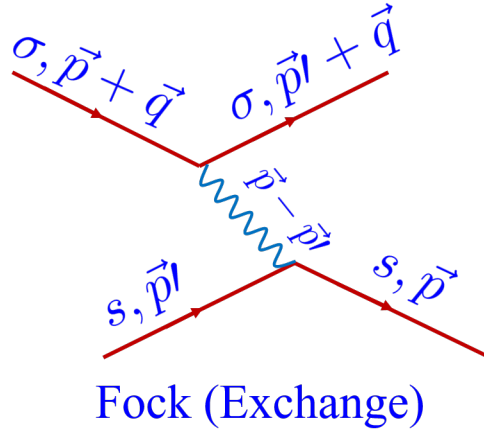

$$\hat{V}_C = \frac{1}{2} \sum_{\vec{p}_1, \vec{p}', \vec{q}, s, \sigma} \hat{\psi}_{-\vec{p}'+\vec{q}, s}^\dagger \hat{\psi}_{\vec{p}', \sigma}^\dagger \tilde{V}(\vec{p} - \vec{p}') \hat{\psi}_{\vec{p}, \sigma} \hat{\psi}_{-\vec{p}+\vec{q}, s}. \quad (8)$$

Each of these three contributions has its own predestinated choice of a slow decoupling field. In general we have the decoupling identity:

$$e^{-\rho, V_{nm} \rho_m} = \mathcal{N} \int \mathcal{D}\phi e^{-\frac{1}{4} \phi_m V_{nm} \phi_n - i \phi_m V_{nm} \rho_n}.$$

The Hartree term should be decoupled in the direct channel $\rho_d(q) = \sum_{p, \sigma} \psi_{p-q, \sigma}^\dagger \psi_{p, \sigma}$. The second in the exchange channel $\rho_x^{\sigma s} = \sum_p \psi_{p, s}^\dagger \psi_{p+q, \sigma}$. The third in the Cooper channel $\rho_c^{\sigma s} = \sum_p \psi_{p, \sigma} \psi_{-p+q, s}$. One thus winds up with an effective theory that contains three independent slow Hubbard-Stratonovich fields. (Notice that the decoupling fields in the exchange and in the Cooper channel carry a spin-structure.)

The three terms may be represented by diagrams, where the circles denote the paired indexes.

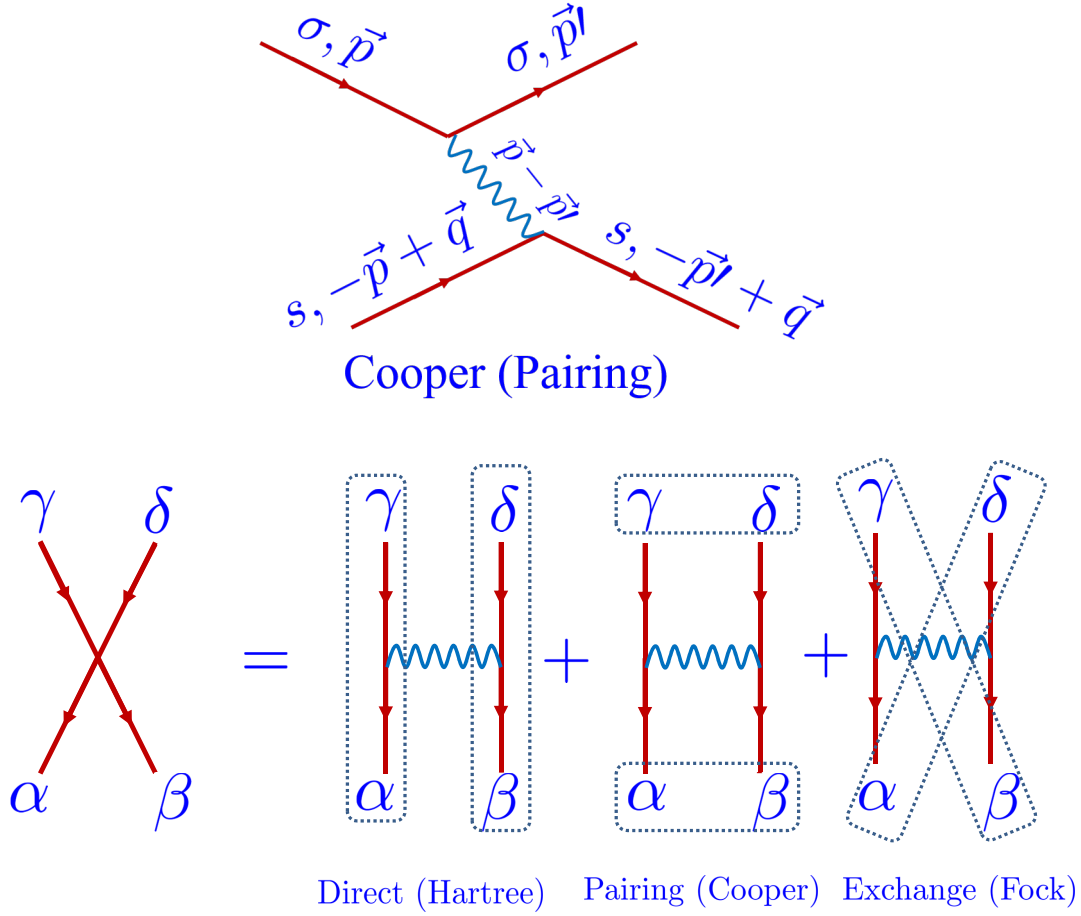

Figure 2: The direct (Hartree), exchange (Fock) and pairing (Cooper) channels.

Localized electrons

Although somewhat different the division to channels may be also performed in case of strong interaction and relatively local wave functions. We then write (neglecting spin orbit coupling) $\psi_\sigma^\dagger(x) = \sum \phi_\alpha(x) c_\alpha^\dagger$ where $\phi_\alpha(x)$ is a local (Wannier) function:

$$\hat{V} = \sum_{\sigma s, \alpha \beta \gamma \delta} \tilde{M}_{\delta\gamma}^{\alpha\beta} c_{\alpha\sigma}^\dagger c_{\beta s}^\dagger c_{\gamma s} c_{\delta\sigma}$$

where

$$M_{\delta\gamma}^{\alpha\beta} = \frac{1}{2} \int d^3x d^3y \phi_\alpha^*(\vec{x}) \phi_\beta^*(\vec{y}) V(\vec{x}, \vec{y}) \phi_\gamma(\vec{y}) \phi_\delta(\vec{x}); \quad \tilde{M}_{\delta\gamma}^{\alpha\beta} = \begin{cases} \frac{1}{3} M_{\delta\gamma}^{\alpha\beta} & \text{if } \alpha = \beta = \gamma = \delta \\ M_{\delta\gamma}^{\alpha\beta} & \text{otherwise} \end{cases}$$

Assuming now that we can neglect interaction terms that do not contain at least two identical indexes¹ we can split \hat{V} into three channels

$$\hat{V} = \sum_{\alpha\gamma\sigma} \tilde{M}_{\alpha\gamma}^{\alpha\gamma} c_{\alpha\sigma}^\dagger c_{\alpha\sigma}^\dagger c_{\gamma s} c_{\gamma s} - \tilde{M}_{\gamma\alpha}^{\alpha\gamma} c_{\alpha\sigma}^\dagger c_{\alpha s} c_{\gamma s}^\dagger c_{\gamma\sigma} + \tilde{M}_{\gamma\gamma}^{\alpha\alpha} c_{\alpha\sigma}^\dagger c_{\alpha s}^\dagger c_{\gamma\sigma} c_{\gamma s},$$

(Notice the factor 1/3 in the diagonal term it is introduced to avoid double counting.) Using the following relation of the Pauli matrices

$$\vec{\sigma}_{\sigma\sigma'} \cdot \vec{\sigma}_{ss'} = \sum_{i=1}^3 \sigma_{\sigma\sigma'}^i \cdot \sigma_{ss'}^i = 2\delta_{\sigma s'} \delta_{\sigma' s} - \delta_{\sigma\sigma'} \delta_{ss'}$$

¹This will be a good approximation, for example, when the interaction is short-range and the wave function ϕ are fairly localized but demand justification in other cases.

and the definitions

$$\hat{n}_\alpha = \sum_\sigma c_{\alpha\sigma}^\dagger c_{\alpha\sigma}, \quad \hat{\vec{s}}_\alpha = \frac{1}{2} \sum_{\sigma s} c_{\alpha\sigma}^\dagger \vec{\sigma}_{\sigma s} c_{\alpha s}, \quad \hat{t}_\alpha = c_{\alpha\uparrow}^\dagger c_{\alpha\downarrow}^\dagger$$

we get

$$\hat{V} = \sum_{\alpha\gamma} \left[\underbrace{(M_{\alpha\gamma}^{\alpha\gamma} - M_{\gamma\alpha}^{\alpha\gamma}/2)}_{\text{Hartree (Direct)}} \hat{n}_\alpha \hat{n}_\gamma - \underbrace{2M_{\gamma\alpha}^{\alpha\gamma} \hat{\vec{s}}_\alpha \cdot \hat{\vec{s}}_\gamma}_{\text{Fock (Exchange)}} + \underbrace{M_{\gamma\gamma}^{\alpha\alpha} \hat{t}_\alpha^\dagger \hat{t}_\gamma^\dagger}_{\text{Cooper (Pairing)}} \right]$$

In cases where the off diagonal Cooper terms are neglected the Hamiltonian reduces to

$$\hat{V} = \sum \tilde{U}_{ij} n_i n_j - 2J_{ij} \vec{s}_i \cdot \vec{s}_j$$

$$\tilde{U}_{ij} = \delta_{ij} U_{ii} + (1 - \delta_{ij}) (U_{ij} - \frac{J_{ij}}{2})$$

and $U_{ij} = M_{ij}^{ij}, J_{ij} = M_{ji}^{ij}$.

2.1.4 Definition of Heisenberg's Model

The Heisenberg model neglects the pairing and the direct terms, so that the Hamiltonian is:

$$H = -2 \sum_{ij} J_{ij} \vec{s}_i \cdot \vec{s}_j$$

with $\vec{s}_i = \frac{1}{2} \psi_{i,\alpha}^\dagger \vec{\sigma}_{\alpha,\beta} \psi_{i,\beta}$

we will further assume

$$J_{ij} = \begin{cases} J_0 & \text{nearest neighbours} \\ 0 & \text{otherwise} \end{cases}$$

and $J_0 > 0$ for a ferromagnetic interaction, $J_0 < 0$ for anti-ferromagnetic interaction.

In the ferromagnetic case ($J_0 > 0$) spins will prefer to be aligned. That happens when the overlap between the i and j orbitals is large. Then (similar to the case of Hund's rule) electron will tend to align their spin due to the Pauli principle. However if we have opposite spins sitting in neighboring atoms then it can be energetically preferable for one to tunnel, which is only possible if the spins are reversed, hence in this situation $J_0 < 0$.

3 Tight Binding and the Hubbard Model (Tutorial)

3.1 Tight binding method

Consider a lattice of static Ions creating a periodic potential,

$$V_{\text{Lattice}}(\vec{r}) = \sum_{\vec{R}} V_{\text{Ion}}(\vec{r} - \vec{R}) = \sum_{\vec{R}} V_{\text{Ion}}^{\vec{R}}(\vec{r}) , \quad (9)$$

where \vec{R} points to the lattice sites and $V_{\text{Ion}}^{\vec{R}}(\vec{r}) = V_{\text{Ion}}(\vec{r} - \vec{R})$ is the potential of the Ion positioned at \vec{R} . In the limit of infinitely far away Ions we can solve the system by solving the Ions independently,

$$\left[\frac{\vec{p}^2}{2m} + V_{\text{Ion}}^{\vec{R}}(\vec{r}) \right] \phi_n^{\vec{R}}(\vec{r}) = \epsilon_n^{\vec{R}} \phi_n^{\vec{R}}(\vec{r}) , \quad (10)$$

where $\phi_n^{\vec{R}}(\vec{r}) = \phi_n(\vec{r} - \vec{R})$ is the eigenstate of the n^{th} orbital of the Ions positioned at \vec{R} , with corresponding energy $\epsilon_n^{\vec{R}}$. The total energy and wavefunction are:

$$E = \sum_{i=1}^N \epsilon_{n_i}^{\vec{R}_i} , \quad (11a)$$

$$\Phi = \text{Slater} \left[\left\{ \phi_{n_i}^{\vec{R}_i} \right\}_{i=1}^N \right] , \quad (11b)$$

where N is the total number of electrons. Upon bringing the Ions closer together there are two main differences to consider:

1. Each site \vec{R} start feeling the potential due to the other sites \vec{R}' . This leads to a small correction to the single Ion potential: $\Delta V_{\vec{R}}(\vec{r}) = \sum_{\vec{R}' \neq \vec{R}} V_{\text{Ion}}^{\vec{R}'}(\vec{r})$.
2. The wavefunctions corresponding to different Ions, positioned at \vec{R} and \vec{R}' , begin to overlap: $\langle \phi_m^{\vec{R}'} | \phi_n^{\vec{R}} \rangle \neq 0$.

Therefore, we do perturbation theory in $\Delta V_{\vec{R}}$, which to first order gives a matrix element for electron tunnelling between sites and orbitals,

$$t_{n,m}^{\vec{R},\vec{R}'} \equiv - \langle \phi_n^{\vec{R}} | \Delta V_{\vec{R}'} | \phi_m^{\vec{R}'} \rangle . \quad (12)$$

It should be noted that, as addressed in point number two above, the set of wavefunctions $|\phi_n^{\vec{R}}\rangle$ are not orthogonal and extra care should be taken to properly derive the tunneling matrix element $t_{n,m}^{\vec{R},\vec{R}'}$. However, we will not dwell on this more in this course. The tight-binding method will be taught in a rigorous manner in the next course, Solid State 2, and can be found also in Ashcroft and Mermin's book [?]. We have so far disregarded the electron spin completely. Adding it is straightforward though, since the potential does not depend on it at all. The eigenstates will simply carry also a spin index, on which the energies are degenerate, and the hopping matrix element t will be diagonal in spin.

In 2nd quantization we define creation and annihilation operators,

$$c_{\vec{R},n,\sigma}^\dagger = \int d^3r \phi_{\vec{R},n,\sigma}(\vec{r}) \psi^\dagger(\vec{r}) , \quad (13a)$$

$$c_{\vec{R},n,\sigma} = \int d^3r \phi_{\vec{R},n,\sigma}^*(\vec{r}) \psi(\vec{r}) , \quad (13b)$$

satisfying $\{c_{\vec{R},n,\sigma}, c_{\vec{R}',m,\sigma'}^\dagger\} = \delta_{\vec{R},\vec{R}'} \delta_{n,m} \delta_{\sigma,\sigma'}$, and the Hamiltonian takes the form

$$H = \sum_{\vec{R},n,\sigma} \epsilon_{\vec{R},n} c_{\vec{R},n,\sigma}^\dagger c_{\vec{R},n,\sigma} - \sum_{\vec{R},\vec{R}',n,m,\sigma} \left(t_{n,m}^{\vec{R},\vec{R}'} c_{\vec{R},n,\sigma}^\dagger c_{\vec{R}',m,\sigma} + h.c. \right) . \quad (14)$$

Before adding electron-electron interactions we will make some simplifications. Some are very widely used, and some are just for our own convenience:

1. We will consider only a single orbital per site, and drop the index n . This is not justified in all systems, but will be enough for our purposes.
2. Since the matrix element for electron hopping, $t_{\vec{R},\vec{R}'}$, decays exponentially with $|\vec{R} - \vec{R}'|$, we will truncate it after nearest neighbours (n.n.). Namely, $t_{\vec{R},\vec{R}'}$ does not vanish only for n.n. sites, denoted by $\langle \vec{R}, \vec{R}' \rangle$.
3. We will assume that all Ions are identical, and set $\epsilon_{\vec{R}} \equiv \mu$ for all \vec{R} as well as $t_{\langle \vec{R}, \vec{R}' \rangle} \equiv t$ for all n.n. \vec{R} and \vec{R}' . Systems where this assumption is wrong are called “inhomogeneous”. In reality all systems are inhomogeneous, but usually the inhomogeneity is weak, and can be neglected or treated in perturbation theory.

Armed with these simplifications, and specializing to one dimension (1d), the system is described by the Hamiltonian,

$$H = \mu \sum_{j,\sigma} c_{j,\sigma}^\dagger c_{j,\sigma} - t \sum_{j,\sigma} \left(c_{j,\sigma}^\dagger c_{j+1,\sigma} + c_{j+1,\sigma}^\dagger c_{j,\sigma} \right). \quad (15)$$

For the rest of the tutorial we will work at half filling, namely one electron per site. Notice that for a fixed number of electrons the μ term is just a constant, and so we will drop it.

To solve this Hamiltonian we use the (discrete) Fourier transform²

$$c_{k,\sigma} = \frac{1}{\sqrt{N}} \sum_j e^{-ikx_j} c_{j,\sigma}, \quad (16a)$$

$$c_{j,\sigma} = \frac{1}{\sqrt{N}} \sum_k e^{ikx_j} c_{k,\sigma}, \quad (16b)$$

where N is the number of sites and $k_n = \frac{2\pi n}{L}$, where $L = Na$ is the length of the system. Notice that $c_{k+\frac{2\pi}{a},\sigma} = c_{k,\sigma}$, so k -space is $\frac{2\pi}{a}$ periodic and it is enough to consider the region $k \in \left[-\frac{\pi}{a}, \frac{\pi}{a}\right)$, namely the first Brillouin Zone (BZ1). Plugging Eq.(16) into Eq.(15) (dropping the μ term) we diagonalize the Hamiltonian

$$\begin{aligned} H &= \sum_{k,q,\sigma} \left[-tc_{k,\sigma}^\dagger c_{q,\sigma} (e^{iq} + e^{-ik}) \right] \frac{1}{N} \sum_j e^{-i(k-q)x_j} \\ &= \sum_{k,q,\sigma} \left[-tc_{k,\sigma}^\dagger c_{q,\sigma} (e^{iqa} + e^{-ika}) \right] \delta_{k,q} \\ &= \sum_{k,\sigma} [-2t \cos(ka)] c_{k,\sigma}^\dagger c_{k,\sigma}, \end{aligned} \quad (17)$$

where we used the fact that $\frac{1}{N} \sum_j e^{-i(k-q)x_j} = \delta_{k,q}$. The solution is depicted in Fig.3. In order to count the number of states we notice that they are spaced $\Delta k = \frac{2\pi}{Na}$ apart spanning $k_{\max} - k_{\min} = \frac{2\pi}{a}$. The number of states is then given by,

$$2 \frac{k_{\max} - k_{\min}}{\Delta k} = 2N, \quad (18)$$

where the factor of 2 is for spin. At half filling (one electron per site, i.e., N electrons) the ground state has the lowest N states occupied. The system is therefore gapless, meaning that it can be excited above the ground state by any infinitesimal energy injection (or temperature). A gapless system of electron is called metallic, since it conducts.

In order to introduce a gap, consider a dimerization of the lattice such that all even sites are slightly displaced from their position³. Instead of changing the distance between Ions we will use a trick and change the tunneling matrix element,

$$t_{j,j+1} = t [1 + \Delta(-1)^j], \quad (19)$$

²One can use various definitions for the Fourier transform, but the symmetric $\frac{1}{\sqrt{N}}$ convention ensures $c_{k,\sigma}^\dagger$ and $c_{k,\sigma}$ are indeed creation and annihilation operators, i.e., have appropriate anti-commutation relations $\{c_{k,\sigma}, c_{q,\sigma'}^\dagger\} = \delta_{k,q} \delta_{\sigma,\sigma'}$.

³In reality, such a dimerization is always energetically favorable in 1d system at half filling, since as the gap opens the (occupied) states near the middle of the gap lower their energy. This lower energy overcomes the energy cost of displacing the Ions. Therefore, the lattice will spontaneously break the translation symmetry from a to $2a$, leading to an insulator rather than a metal. This effect is called Peierls instability, or Peierls transition.

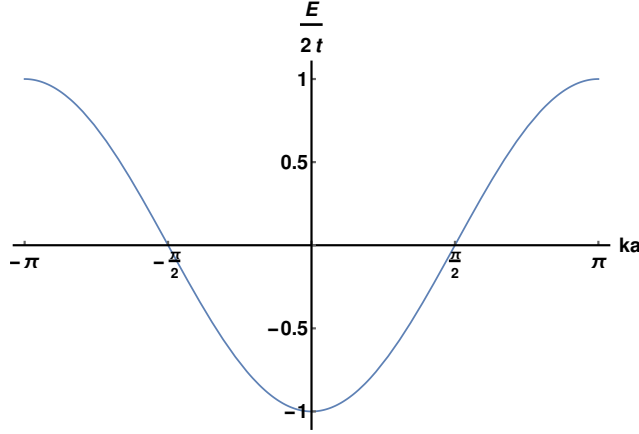

Figure 3: Spectrum of a free fermion on a 1d lattice in the tight-binding approximation. The energy band is doubly degenerate in the spin degree of freedom. At half filling all state below zero (between $-\pi/2$ and $\pi/2$) are filled.

where Δ is governed by the displacement of the Ions. Indeed doing so captures essentially the same physics since, as can be seen in Eq.(12), the size of t relates to the distance between Ions. Notice that now the symmetry for translation by a is broken, and one must define a unit cell of size $2a$ with two Ions in the unit cell. We will denote the creation operators on odd sites by $A_{j,\sigma}^\dagger$ and those on even by $B_{j,\sigma}^\dagger$. The Hamiltonian can now be written as

$$H = -t(1 - \Delta) \sum_{j,\sigma} \left(A_{j,\sigma}^\dagger B_{j,\sigma} + B_{j,\sigma}^\dagger A_{j,\sigma} \right) - t(1 + \Delta) \sum_{j,\sigma} \left(A_{j+1,\sigma}^\dagger B_{j,\sigma} + B_{j,\sigma}^\dagger A_{j+1,\sigma} \right) . \quad (20)$$

We now transform again to k-space using the definitions (16), but with $2a$ and $\frac{N}{2}$ unit cells to get

$$H = \sum_{k,\sigma} \vec{C}_{k,\sigma}^\dagger \begin{pmatrix} 0 & -t' - \tilde{t}e^{i2ka} \\ -t' - \tilde{t}e^{-i2ka} & 0 \end{pmatrix} \vec{C}_{k,\sigma} \equiv \sum_{k,\sigma} \vec{C}_{k,\sigma}^\dagger H(k) \vec{C}_{k,\sigma} , \quad (21)$$

where $\vec{C}_{k,\sigma} = \begin{pmatrix} A_{k,\sigma} & B_{k,\sigma} \end{pmatrix}^T$, $t' = t(1 - \Delta)$ and $\tilde{t} = t(1 + \Delta)$. To completely solve the system we just need to diagonalize withing the unit cell, namely the two-by-two matrix $H(k)$. This can be done easily by first noticing that

$$H(k) = \vec{d}_k \cdot \vec{\tau} = |d_k| \vec{n} \cdot \vec{\tau}, \quad (22)$$

where $\vec{n} = \begin{pmatrix} \cos 2\theta_k & \sin 2\theta_k & 0 \end{pmatrix}$ is a unit vector, $\vec{\tau}$ is a vector of Pauli matrices (here not related to the spin degree of freedom but rather to ‘‘pseudo spin’’), $|d_k|$ is the mudulus of \vec{d}_k and $\theta_k = \frac{1}{2} \arctan \left[\frac{\tilde{t} \sin(2ka)}{-t' - \tilde{t} \cos(2ka)} \right]$. The energies and eigenstates are then

$$E_{\pm}(k) = \pm |d_k| = \pm 2t \sqrt{1 - (1 - \Delta^2) \sin^2(ka)} , \quad (23a)$$

$$\Gamma_{\pm}(k) = \frac{1}{\sqrt{2}} \begin{pmatrix} e^{-i2\theta_k} \\ \pm 1 \end{pmatrix} = \frac{1}{\sqrt{2}} (e^{-i2\theta_k} A_{k,\sigma} \pm B_{k,\sigma}) , \quad (23b)$$

and are depicted in Fig.4 for $\Delta = 0.2$. Notice that there are two bands now, corresponding to the two sites in the unit cell, and a gap between them. At half filling the lower band is completely full, while the upper is completely empty, and the system is gapped. Meaning that exciting the system requires overcoming a finite energy gap, in this case 2Δ . For example, thermal excitation of the system is suppressed by a Boltzman factor of $\exp[-k_B T/2\Delta]$. A gapped system of electrons is called insulating since it does not conduct.

3.2 The Hubbard Model

After playing around with the simplest non-interacting tight binding model we are ready to add interactions. We will do so in three dimensions (3d). Consider electron-electron interactions of the form

$$V_{\text{el-el}} = \sum_{\sigma,\sigma'} \int d^3 r d^3 r' V(\vec{r} - \vec{r}') \psi_{\sigma}^\dagger(\vec{r}) \psi_{\sigma'}^\dagger(\vec{r}') \psi_{\sigma'}(\vec{r}') \psi_{\sigma}(\vec{r}) , \quad (24)$$

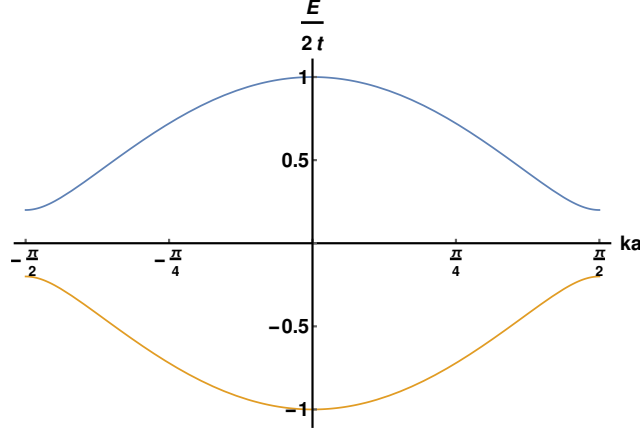

Figure 4: Spectrum of a free fermion on a dimerized 1d lattice in the tight-binding approximation. Both energy bands are doubly degenerate in the spin degree of freedom. At half filling the lower band is filled, while the upper is completely empty.

where $V(\vec{r} - \vec{r}')$ could for example be Coulomb repulsion. In the tight binding approximation, roughly speaking using Eq.(13), the interactions are given by

$$\tilde{V}_{\text{el-el}} = \sum_{\vec{R}} U_{\vec{R},\vec{R}} n_{\vec{R},\uparrow} n_{\vec{R},\downarrow} + \sum_{\vec{R}' \neq \vec{R}} U_{\vec{R},\vec{R}'} n_{\vec{R}} n_{\vec{R}'} + \sum_{\vec{R}' \neq \vec{R}, \sigma, \sigma'} J_{\vec{R},\vec{R}'}^F c_{\vec{R},\sigma}^\dagger c_{\vec{R}',\sigma'}^\dagger c_{\vec{R},\sigma} c_{\vec{R}',\sigma'} , \quad (25)$$

where $n_{\vec{R}} = \sum_{\sigma} n_{\vec{R},\sigma}$ is the electron density on the site positioned at \vec{R} , $n_{\vec{R},\sigma}$ is the density of electrons of spin σ on the site positioned at \vec{R} , and the various matrix elements are:

$$U_{\vec{R},\vec{R}'} = \frac{1}{2} \int d^3 r_1 d^3 r_2 V(\vec{r}_1 - \vec{r}_2) |\phi_{\vec{R}}(\vec{r}_1)|^2 |\phi_{\vec{R}'}(\vec{r}_2)|^2 , \quad (26a)$$

$$J_{\vec{R},\vec{R}'}^F = \frac{1}{2} \int d^3 r_1 d^3 r_2 V(\vec{r}_1 - \vec{r}_2) \phi_{\vec{R}}(\vec{r}_1) \phi_{\vec{R}'}^*(\vec{r}_1) \phi_{\vec{R}'}(\vec{r}_2) \phi_{\vec{R}}^*(\vec{r}_2) . \quad (26b)$$

Notice that again we have three free parameters reminiscent of the “three channels”. Here however, $J_{\vec{R},\vec{R}'}^F$ is very small compared to $U_{\vec{R},\vec{R}'}$, since it includes two overlap integrals of wavefunctions centered around different sites. By far the most important term in Eq.(25) is $U_{\vec{R},\vec{R}}$. Consequently, the other terms are commonly truncated⁴ resulting in the so-called Hubbard model

$$H_{\text{Hubbard}} = -t \sum_{\langle \vec{R},\vec{R}' \rangle, \sigma} \left(c_{\vec{R},\sigma}^\dagger c_{\vec{R}',\sigma} + h.c. \right) + U \sum_{\vec{R}} n_{\vec{R},\uparrow} n_{\vec{R},\downarrow} , \quad (27)$$

where $U = U_{\vec{R},\vec{R}}$ which again is assumed to be the same for all \vec{R} . Although we have omitted many terms that in reality are present, the resulting simplified model is still surprisingly rich. Moreover, even though it is arguably the simplest interacting electron model one can write down, we do not know how to solve it exactly. Therefore, we will consider various limits.

We already treated the $U = 0$ case in 1d. Generalizing it to 3d is straightforward, and we will skip it. One can treat $U \ll t$ using perturbation theory in $\frac{U}{t}$. It does not lead to dramatic effects, and we will skip that as well. Interesting results occur for the $t = 0$ and $t \ll U$ limits, and so we will focus on these. For $t = 0$ the Hamiltonian reduces to

$$H_0 = U \sum_{\vec{R}} n_{\vec{R},\uparrow} n_{\vec{R},\downarrow} , \quad (28)$$

for which the (degenerate) ground states can be easily inferred for any number of electrons. At half filling the ground state energy is $E = 0$ and the ground states have all sites occupied by a single electron. Lowest excited states, those that have one doubly occupied site, have a finite energy U , so the system is again gapped, but now due to interactions (rather

⁴We will return to the $J_{\vec{R},\vec{R}'}^F$ term later on in this tutorial.

than band-structure). This is called a Mott insulator. As opposed to a band insulator, which is completely inert, in this Mott insulator there are still low energy degrees of freedom, namely the spins of the electrons

$$S_{\vec{R}}^{\mu} = \frac{1}{2} \sum_{s,s'} c_{\vec{R},s}^{\dagger} \sigma_{s,s'}^{\mu} c_{\vec{R},s'} . \quad (29)$$

The many degenerate ground states correspond to all possible configurations of the spins of the electrons. This degeneracy is lifted by any finite t leading to a tunneling Hamiltonian,

$$H_t = -t \sum_{\langle \vec{R}, \vec{R}' \rangle, \sigma} \left(c_{\vec{R},\sigma}^{\dagger} c_{\vec{R}',\sigma} + h.c. \right) , \quad (30)$$

which will prefer certain spin configurations. We will treat H_t in perturbation theory and derive an effective Hamiltonian for the degenerate ground space. To second order in perturbation theory the effective Hamiltonian is given by

$$H_{\text{eff}} = P_0 H_t P_0 + P_0 H_t P_1 \frac{1}{E_0 - H_0} P_1 H_t P_0 + O\left(\frac{t^3}{U^2}\right) , \quad (31)$$

where $P_0 = \sum_{\alpha \in \text{g.s.}} |\alpha\rangle \langle \alpha|$ is the projection operator to the ground space, and $P_1 = 1 - P_0 = \sum_{a \notin \text{g.s.}} |a\rangle \langle a|$ is the complementary projection. The first term in Eq.(31) clearly vanishes since H_t connects states in P_0 with states in P_1 which are the orthogonal to states in P_0 . The second term can be simplified by noting:

1. The g.s. energy is zero, namely $E_0 = 0$.
2. Since H_t acting on states in P_0 creates only one double occupied site, all states in $P_1 H_t P_0$ have exactly one doubly occupied site.

We can then write:

$$\begin{aligned} H_{\text{eff}} &= \sum_{\alpha, \beta \in \text{g.s.}} \sum_{a, b \in 1 \text{ d.o.}} |\alpha\rangle \langle \alpha| H_t |a\rangle \langle a| \frac{1}{-H_0} |b\rangle \langle b| H_t |\beta\rangle \langle \beta| + O\left(\frac{t^3}{U^2}\right) \\ &= -\frac{1}{U} \sum_{\alpha, \beta \in \text{g.s.}} \sum_{a, b \in 1 \text{ d.o.}} |\alpha\rangle \langle \alpha| H_t |a\rangle \langle a| b\rangle \langle b| H_t |\beta\rangle \langle \beta| + O\left(\frac{t^3}{U^2}\right) \\ &= -\frac{1}{U} \sum_{\alpha, \beta \in \text{g.s.}} \sum_{a \in 1 \text{ d.o.}} |\alpha\rangle \langle \alpha| H_t |a\rangle \langle a| H_t |\beta\rangle \langle \beta| + O\left(\frac{t^3}{U^2}\right) \\ &= -\frac{1}{U} \sum_{\alpha, \beta \in \text{g.s.}} \langle \alpha| H_t^2 |\beta\rangle |\alpha\rangle \langle \beta| + O\left(\frac{t^3}{U^2}\right) , \end{aligned} \quad (32)$$

So we need to compute that Matrix elements $\langle \alpha| H_t^2 |\beta\rangle$. Since $H_t = \sum_{\langle \vec{R}, \vec{R}' \rangle} (H_t)_{\vec{R}, \vec{R}'}$ only connect n.n. we concentrate on the spin configuration of two specific n.n. sites \vec{R} and \vec{R}' . We denote the states in short $|\beta\rangle = |\dots, \sigma_{\vec{R}}, \sigma'_{\vec{R}'}, \dots\rangle \equiv |\sigma_{\vec{R}}, \sigma'_{\vec{R}'}\rangle$, and look at the various cases:

- (I) If both spins are oriented at the same direction, namely $|\beta\rangle = |\uparrow_{\vec{R}}, \uparrow_{\vec{R}'}\rangle$ or $|\beta\rangle = |\downarrow_{\vec{R}}, \downarrow_{\vec{R}'}\rangle$, they will be annihilated by $(H_t)_{\vec{R}, \vec{R}'}$ since the site \vec{R} (or \vec{R}') cannot be occupied by two electrons with the same spin (Pauli exclusion principle):

$$(H_t)_{\vec{R}, \vec{R}'} |\sigma_{\vec{R}}, \sigma_{\vec{R}'}\rangle = 0 . \quad (33)$$

- (II) If the spins are opposite, namely $|\beta\rangle = |\uparrow_{\vec{R}}, \downarrow_{\vec{R}'}\rangle$ or $|\beta\rangle = |\downarrow_{\vec{R}}, \uparrow_{\vec{R}'}\rangle$, then $(H_t)_{\vec{R}, \vec{R}'}$ leads to a doubly occupied site \vec{R} or \vec{R}' :

$$(H_t)_{\vec{R}, \vec{R}'} |\sigma_{\vec{R}}, \bar{\sigma}_{\vec{R}'}\rangle = -t |\sigma_{\vec{R}} \bar{\sigma}_{\vec{R}}, 0\rangle - t |0, \sigma_{\vec{R}'} \bar{\sigma}_{\vec{R}}\rangle . \quad (34)$$

The second $(H_t)_{\vec{R}, \vec{R}'}$ then splits them back onto both sites, by either going back to the original state or by exchanging the electrons:

(a) Back to original state:

$$(H_t)_{\bar{R},\bar{R}'}^2 |\sigma_{\bar{R}}, \bar{\sigma}_{\bar{R}'}\rangle = 2t^2 |\sigma_{\bar{R}}, \bar{\sigma}_{\bar{R}'}\rangle . \quad (35)$$

(b) Exchanged electrons:

$$(H_t)_{\bar{R},\bar{R}'}^2 |\sigma_{\bar{R}}, \bar{\sigma}_{\bar{R}'}\rangle = -2t^2 |\bar{\sigma}_{\bar{R}}, \sigma_{\bar{R}'}\rangle . \quad (36)$$

The extra minus sign in this case comes from the exchange of the electrons, and can be seen explicitly:

$$\begin{aligned} & (H_t)_{\bar{R},\bar{R}'}^2 |\sigma_{\bar{R}}, \bar{\sigma}_{\bar{R}'}\rangle \\ &= (H_t)_{\bar{R},\bar{R}'} \left(-tc_{\bar{R}',\uparrow}^\dagger c_{\bar{R},\uparrow} - tc_{\bar{R},\downarrow}^\dagger c_{\bar{R}',\downarrow} \right) |\sigma_{\bar{R}}, \bar{\sigma}_{\bar{R}'}\rangle \\ &= \left[\left(-tc_{\bar{R},\downarrow}^\dagger c_{\bar{R}',\downarrow} \right) \left(-tc_{\bar{R}',\uparrow}^\dagger c_{\bar{R},\uparrow} \right) + \left(-tc_{\bar{R}',\uparrow}^\dagger c_{\bar{R},\uparrow} \right) \left(-tc_{\bar{R},\downarrow}^\dagger c_{\bar{R}',\downarrow} \right) \right] |\sigma_{\bar{R}}, \bar{\sigma}_{\bar{R}'}\rangle \\ &= t^2 \left(c_{\bar{R},\downarrow}^\dagger c_{\bar{R},\uparrow} c_{\bar{R}',\downarrow} c_{\bar{R}',\uparrow}^\dagger + c_{\bar{R},\uparrow} c_{\bar{R},\downarrow}^\dagger c_{\bar{R}',\uparrow}^\dagger c_{\bar{R}',\downarrow} \right) |\sigma_{\bar{R}}, \bar{\sigma}_{\bar{R}'}\rangle \\ &= -2t^2 c_{\bar{R},\downarrow}^\dagger c_{\bar{R},\uparrow} c_{\bar{R}',\uparrow}^\dagger c_{\bar{R}',\downarrow} |\sigma_{\bar{R}}, \bar{\sigma}_{\bar{R}'}\rangle \\ &= -2t^2 |\bar{\sigma}_{\bar{R}}, \sigma_{\bar{R}'}\rangle . \end{aligned} \quad (37)$$

Noticing that $S_{\bar{R}}^z = \frac{1}{2} [|\uparrow_{\bar{R}}\rangle \langle \uparrow_{\bar{R}}| - |\downarrow_{\bar{R}}\rangle \langle \downarrow_{\bar{R}}|]$, $S_{\bar{R}}^+ = |\uparrow_{\bar{R}}\rangle \langle \downarrow_{\bar{R}}|$ and $S_{\bar{R}}^- = |\downarrow_{\bar{R}}\rangle \langle \uparrow_{\bar{R}}|$ we write cases (I) and (II)(a) as

$$-\frac{2t^2}{U} [|\uparrow_{\bar{R}}, \downarrow_{\bar{R}'}\rangle \langle \uparrow_{\bar{R}}, \downarrow_{\bar{R}'}| + |\downarrow_{\bar{R}}, \uparrow_{\bar{R}'}\rangle \langle \downarrow_{\bar{R}}, \uparrow_{\bar{R}'}|] = \frac{4t^2}{U} (S_{\bar{R}}^z S_{\bar{R}'}^z - \frac{1}{4}) , \quad (38)$$

and case (II)(b) as

$$\frac{2t^2}{U} [|\uparrow_{\bar{R}}, \downarrow_{\bar{R}'}\rangle \langle \downarrow_{\bar{R}}, \uparrow_{\bar{R}'}| + |\downarrow_{\bar{R}}, \uparrow_{\bar{R}'}\rangle \langle \uparrow_{\bar{R}}, \downarrow_{\bar{R}'}|] = \frac{2t^2}{U} (S_{\bar{R}}^- S_{\bar{R}'}^+ + S_{\bar{R}}^+ S_{\bar{R}'}^-) . \quad (39)$$

In total, summing over all n.n. we get (dropping the constant factor) the effective Hamiltonian

$$H_{\text{eff}} = J \sum_{\langle \bar{R}, \bar{R}' \rangle} \left[S_{\bar{R}}^z S_{\bar{R}'}^z + \frac{1}{2} (S_{\bar{R}}^- S_{\bar{R}'}^+ + S_{\bar{R}}^+ S_{\bar{R}'}^-) \right] = J \sum_{\langle \bar{R}, \bar{R}' \rangle} \vec{S}_{\bar{R}} \cdot \vec{S}_{\bar{R}'} , \quad (40)$$

with $J = \frac{4t^2}{U} > 0$, namely a Heisenberg anti-ferromagnet. Recall now that earlier in the tutorial we truncated the interaction term

$$H_{J^F} = J^F \sum_{\langle \bar{R}, \bar{R}' \rangle} c_{\bar{R},\sigma}^\dagger c_{\bar{R}',\sigma'}^\dagger c_{\bar{R},\sigma'} c_{\bar{R}',\sigma} , \quad (41)$$

and the $V \sum_{\langle \bar{R}, \bar{R}' \rangle} n_{\bar{R}} n_{\bar{R}'}$. The latter is trivial in the ground space, namely $P_0 n_{\bar{R}} n_{\bar{R}'} P_0 = 1$, but the former actually also gives a Heisenberg Hamiltonian

$$P_0 H_{J^F} P_0 = -2J^F \sum_{\langle \bar{R}, \bar{R}' \rangle} \vec{S}_{\bar{R}} \cdot \vec{S}_{\bar{R}'} . \quad (42)$$

It can be shown that for Coulomb interaction (and also for a contact interaction) $J^F > 0$, namely this interaction is ferromagnetic. Previously we could disregard it with respect to U , but now that the effective Hamiltonian (40) is of order $\frac{t^2}{U}$ the two can be comparable and should be taken together. Indeed different systems can have either one of them dominating over the other and consequently display either ferromagnetism or antiferromagnetism. This is the main mechanism by which magnetism arises in systems.

The Hubbard model can also describe BCS superconductivity. This requires changing of the sign of U from positive to negative, i.e., from repulsive to attractive. We will not dwell at this stage on how can electrons have an attractive density-density interaction (obviously Coulomb is not enough), but take this axiomatically and see how it leads to the formation of cooper pairs. Consider the following transformation on the creation and annihilation operators

$$\begin{cases} c_{\uparrow, \bar{R}} \rightarrow d_{\uparrow, \bar{R}} \\ c_{\downarrow, \bar{R}} \rightarrow (-1)^{\bar{R}} d_{\downarrow, \bar{R}}^\dagger \end{cases} , \quad (43)$$

where $(-1)^{\vec{R}}$ is the parity of the site at position \vec{R} , e.g. $(-1)^{x/a+y/a+z/a}$ on a 3d cubic lattice with unit cell of size a^3 . It is easy to check that the d operators are also creation and annihilation operators, and plugging this into the Hubbard model we find

$$H_{\text{Hubbard}} = -t \sum_{\langle \vec{R}, \vec{R}' \rangle, \sigma} \left(d_{\vec{R}, \sigma}^\dagger d_{\vec{R}', \sigma} + h.c. \right) - U \sum_{\vec{R}} n_{\vec{R}, \uparrow} n_{\vec{R}, \downarrow}, \quad (44)$$

namely the Hubbard model but with $U \rightarrow -U$. Performing the same transformation on the spin operators we find

$$\begin{cases} S_{\vec{R}}^z \rightarrow n_{\vec{R}} \\ S_{\vec{R}}^+ \rightarrow (-1)^{\vec{R}} d_{\uparrow}^\dagger d_{\downarrow}^\dagger \\ S_{\vec{R}}^- \rightarrow (-1)^{\vec{R}} d_{\downarrow} d_{\uparrow} \end{cases}. \quad (45)$$

We conclude that there is a correspondence between magnetism in the repulsive Hubbard model and cooper pairs in the attractive Hubbard model. We will learn more about superconductivity later in the course.

4 Mean Field Solution of the Heisenberg Model – Spontaneous Symmetry Breaking

Before discussing the mean field solution of the Heisenberg Model let us discuss the general mean field approach in general.

4.1 General Mean Field approximation

The general approach is to take a Hamiltonian of the form

$$H = A + B + AB$$

and simplify the interaction term by replacing the operator A by $A \rightarrow \langle A \rangle + \Delta A$, where $\langle A \rangle$ is the mean value, and ΔA contains the fluctuations around it. Within the mean-field approximation we will assume that ΔA is small. For consistency we need to check in the resulting solution that we have

$$\Delta A \ll \langle A \rangle,$$

otherwise the mean field solution is incorrect.

After a similar substitution for B

$$\begin{aligned} H &= A + B + A(B - \Delta B) + (A - \Delta A)B + \Delta A \Delta B - (A - \Delta A)(B - \Delta B) \\ &= A + B + A \langle B \rangle + \langle A \rangle B + \Delta A \Delta B - \langle A \rangle \langle B \rangle. \end{aligned}$$

Assuming the fluctuations are small we define the mean field Hamiltonian

$$H_{\text{MF}} = A + B + A \langle B \rangle + \langle A \rangle B - \langle A \rangle \langle B \rangle.$$

4.1.1 Mean Field solution of the Heisenberg model

Coming back to the Heisenberg case we have

$$H_{\text{MF}} = -2 \sum_{ij} J_{ij} \langle s_i \rangle s_j - 2 \sum_{ij} J_{ij} s_i \langle s_j \rangle + 2 \sum_{ij} J_{ij} \langle s_i \rangle \langle s_j \rangle$$

since we can rotate all the spins together without changing the Hamiltonian, we will have $\langle s_i \rangle = 0$ in the absence of any symmetry breaking (i.e., if the ground state respects the symmetry for rotations). We look for a situation where spontaneous symmetry breaking does occur, i.e., the system develops a spontaneous magnetization. In the case of symmetry breaking we look for a state where $\langle s_i \rangle = \langle s_z \rangle \hat{e}_z$. We define the magnetization

$$m = 2 \sum_{\langle j \rangle} J_{ij} \langle s_z \rangle \hat{e}_z = 2nJ_0 \langle s_z \rangle \hat{e}_z$$

where n is the number of neighbors. Then if the total number of spins is N,

$$H_{\text{MF}} = -2 \sum_i \vec{m} \cdot \vec{s}_i + |\vec{m}| N \langle s_z \rangle$$

We write the partition function

$$Z_{\text{MF}} = \text{Tr} (e^{-\beta H_{\text{MF}}}) = (e^{\beta m} + e^{-\beta m})^N e^{\beta m N \langle s_z \rangle} = \left((e^{\beta m} + e^{-\beta m}) e^{\beta m^2 / 2nJ_0} \right)^N$$

We want to minimize the free energy with respect to m to find the equilibrium value:

$$\frac{\partial F}{\partial m} = -\frac{1}{\beta} \frac{\partial \ln Z}{\partial m} = N \frac{e^{\beta m} - e^{-\beta m}}{e^{\beta m} + e^{-\beta m}} + N \frac{m}{nJ_0} = 0$$

defining $a = \frac{m}{nJ_0}$, $b = nJ_0\beta$ we obtain

$$a = \tanh(ab).$$

If we consider a as an order parameter which is zero in the disordered phase (since it is proportional to m), we can assume that it is small and expand:

$$a \cong ba - \frac{1}{3}(ba)^3$$

we can look at different cases:

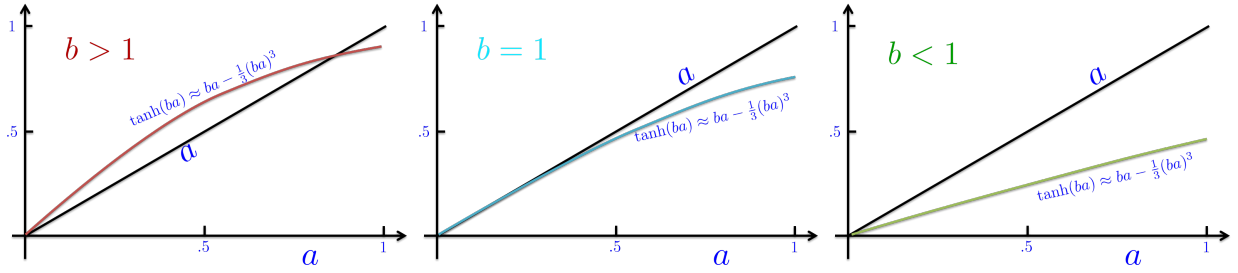

Figure 5: for $b < 1$ the two lines do not cross so there is no solution while for $b > 1$ there is a solution. The value $b = 1 = nJ_0/T_c$ defines the phase transition temperature T_c .

from which we can see that we get a non-zero solution only if $b > 1$. The value of b which separates the two regimes defines a critical temperature:

$$b = 1 \Rightarrow kT_c = nJ_0.$$

For small a we can solve giving

$$a = \frac{1}{b} \sqrt{\frac{3(b-1)}{b}} \Rightarrow m = nJ_0 \sqrt{3 \frac{T_c - T}{T_c}}$$

taking $T \rightarrow 0 \Rightarrow b \rightarrow \infty$ we get $a \rightarrow 1$ which means $m \rightarrow nJ_0$ giving the following phase diagram

4.2 Goldstone Modes (Magnons)

The fact that when continuous symmetry is broken a soft (“gapless”) Goldstone mode arises is a general phenomenon. To be explicit, we will work on the Heisenberg model and consider the 1D case although similar results hold for higher dimensions.

We would like to find the low energy excitation of the problem. The ground state is $|G\rangle = |\uparrow\uparrow \dots \uparrow\rangle$, i.e., the state where all the spin point up.

$$H|G\rangle = -2J \sum_{ij} \vec{s}_i \cdot \vec{s}_j |G\rangle = -2J_0 \sum_{\langle ij \rangle} s_i^z s_j^z |G\rangle - J_0 \sum_{\langle ij \rangle} s_i^+ s_j^- + s_i^- s_j^+ |G\rangle = -2J_0 N s^2 |G\rangle = E_G |G\rangle.$$

Notice that the term S_i^+ destroy the state as the spin is already in its maximal value and in the last equation the pre-factor is correct only in one dimension as each spin interacts with its left and right spin but we have to avoid double counting.

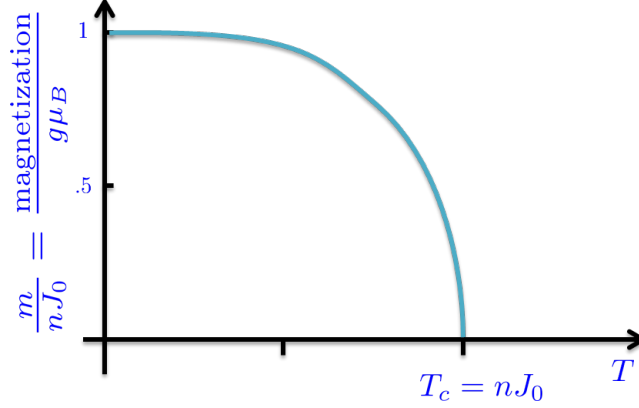

Figure 6: The magnetization as a function of the temperature

In looking for the energy of the excited states it is reasonable to assume that the first excited states will be build of linear coherent combination of a single spin flip.

Denoting the single spin states: $|i\rangle = |\uparrow \uparrow \dots \uparrow \underbrace{\downarrow}_{i^{\text{th}} \text{ position}} \uparrow \uparrow\rangle$ and projecting on these single spin states is done by writing

$$H = \sum_{ij} |i\rangle \langle i| H |j\rangle \langle j|.$$

The diagonal terms take the form $\langle i| H |i\rangle = E_G + 2JS^2$ as two bonds are flipped (we assume that the spins are not at the edge of the sample). However, because of the nearest neighbor coupling terms, the above states are not eigenstates of the Hamiltonian. Due to the definition of the Heisenberg model, off diagonal matrix elements do not vanish only for nearest neighbor and given by $\langle i| H |i+1\rangle = JS^2$ combing these we get the Hamiltonian (for the 1D case)

$$H = (E_G + 2JS^2) \sum_i |i\rangle \langle i| - JS^2 \sum_i (|i+1\rangle \langle i| + |i\rangle \langle i+1|),$$

which can be solved by a fourier transform: $|q\rangle = \sum_j e^{iqaj} |j\rangle$, with a being the lattice constant. In general, such translation invariant quadratic Hamiltonians can be diagonalized by going to Fourier space. We diagonalize the Hamiltonian and get the spectrum :

$$E_q = E_G + 2JS^2 [1 - \cos(qa)].$$

Taking $q \rightarrow 0$ the excited state energies are

$$E_q - E_G \rightarrow Ja^2 q^2.$$

These are the soft modes known as the Goldstone modes - their energy goes to 0 as the wave number goes to 0.

Generally the Goldstone modes are linear in q and not quadratic in q as in the ferromagnetic case. In the ferromagnetic case, our order parameter $\vec{M} \propto \vec{S}^{\text{tot}} = \sum_{\alpha} \vec{s}_{\alpha}$ commutes with the Hamiltonian:

$$\sum_{\alpha\beta\gamma} [S_{\alpha}^i S_{\beta}^i, S_{\gamma}^k] = \sum_{\alpha\beta\gamma} S_{\alpha}^i [S_{\beta}^i, S_{\gamma}^k] + [S_{\alpha}^i, S_{\gamma}^k] S_{\beta}^i = \sum_{\alpha\beta\gamma} i\epsilon_{ikj} (S_{\alpha}^i S_{\gamma}^j \delta_{\beta\gamma} + S_{\alpha}^i S_{\beta}^j \delta_{\alpha\gamma}) = \vec{S}^{\text{tot}} \times \vec{S}^{\text{tot}} = 0.$$

Indeed writing the equation of motion in real space, assuming we have a quadratic dispersion, we get

$$\dot{m} = D\nabla^2 m.$$

An integration gives a conserved total magnetization

$$\dot{M} = D \oint \nabla m = 0,$$

which would not have happened if we had a linear dispersion.

(Remark: the situation is similar to the diffusion equation of particles that is quadratic in q implying that the total number of particle is conserved.)

In the above we have demonstrated the very important concept of Goldstone bosons. These are gapless modes (or fields) that occur in quantum and classical field theories whenever a continuous symmetry is spontaneously broken.

4.2.1 Holstein-Primakoff

Before we talked about a system of spin $\frac{1}{2}$. Now we turn to talk about very large spins, for which (as we will see below) quantum fluctuations become less important.

We seek a semi-classical approximation for the Heisenberg model. Considering $\Delta x \Delta p = \langle [x, p] \rangle \sim \hbar$, the spin fluctuations obey

$$\Delta s_i \Delta s_j = \langle [s_i, s_j] \rangle = |\varepsilon_{ijk} \langle s_k \rangle| \leq s$$

$$\frac{\Delta s_i}{s} \frac{\Delta s_j}{s} \leq \frac{1}{s} \xrightarrow{s \rightarrow \infty} 0$$

hence quantum fluctuations become negligible when we increase the spin size. Adding a lower index to denote lattice site,

$$[s_m^k, s_n^l] = i\varepsilon_{klj} s_n^j \delta_{mn}$$

and defining $s_m^\pm = s_m^x \pm i s_m^y$ we have

$$[s_m^+, s_n^-] = 2\delta_{mn} s_m^z, [s_m^z, s_n^\pm] = \pm \delta_{nm} s_m^\pm$$

All this has been exact. Defining

$$s_m^- = a_m^\dagger \sqrt{2s - a_m^\dagger a_m}, \quad s_m^+ = \sqrt{2s - a_m^\dagger a_m} a_m, \quad s_m^z = s - a_m^\dagger a_m$$

where a_m are bosonic ladder operators, we can check that the new operators obey the same commutation relations. The HP approximation is taking the limit $s \rightarrow \infty$ (where s is the spin in each lattice) giving

$$s_m^- \approx \sqrt{2s} a_m^\dagger, \quad s_m^+ \approx \sqrt{2s} a_m$$

in 1D with periodic BC we have

$$\begin{aligned} H &= -2J \sum_m \left(s_m^z s_{m+1}^z + \frac{1}{2} (s_m^+ s_{m+1}^- + s_m^- s_{m+1}^+) \right) \\ &\xrightarrow{s \rightarrow \infty} -2JN s^2 - 2Js \sum_m (-2a_m^\dagger a_m + a_m^\dagger a_{m+1} + h.c.) \end{aligned}$$

Using periodic BC $s_{m+N} = s_m \Rightarrow a_{m+N}^\dagger = a_m$ and moving to Fourier space with $a_m = \frac{1}{\sqrt{N}} \sum e^{-ikm} a_k$ giving

$$\hbar\omega_k = 4Js(1 - \cos k) \xrightarrow{k \rightarrow 0} 2Jsk^2$$

giving the same dispersion relation we found before.

Using the mean field analysis, we were able to demonstrate, neglecting fluctuations, that the Heisenberg model has a ferromagnetic (ordered) phase which may occur at low temperatures. Once we understood that there is a ferromagnetic phase, we turned to study the relevant degrees of freedom describing low energy excitations in this phase. In our case, these were the gapless spin waves (and in more general cases, these are called Goldstone modes). For the ferromagnetic phase to be stable, the fluctuations generated by the Goldstone modes must not destroy the order. As we will see below, this self consistency requirement is not fulfilled in low dimensions, leading to the absence of spontaneous symmetry breaking in 1D and 2D systems with continuous symmetries.

4.2.2 Absence of LRO (Long Range Order) in 1D and 2D systems with broken continuous symmetries - Mermin-Wagner Theorem

4.2.3 Average magnetization

We turn to study the deviations of the magnetization from it's maximal value. Within the Holstein-Primakoff approach, this takes the form

$$\frac{\Delta m}{2Jns} = \frac{1}{N} \langle s_{tot}^z \rangle - s = -\frac{1}{N} \sum_k n_k$$

where n_k are the average number operators, $n_k = \frac{1}{e^{-\omega_k/T} - 1}$, where we have used the fact that n_k counts the number of excitations with a given k , which are decoupled bosons of energy ω_k .

To perform the summation we introduce an IR cutoff $k_0 \sim \frac{1}{L}$ for system size L and assuming $\hbar\omega_{\tilde{k}} < T < Js$ we expand the exponent and set the expression for $\omega_{\tilde{k}}$ that we found

$$\Delta m = -\int_{k_0}^{\tilde{k}} \frac{dk k^{d-1}}{(2\pi)^d} \frac{T}{2Jsk^2} - \frac{1}{N} \sum_{k > \tilde{k}} n_k$$

There is a clear dependence on dimensionality, in one and two dimensions the first term diverges with system size:

$$\Delta m \propto \begin{cases} -\frac{T}{2Js} \frac{1}{k_0} & 1D \\ -\frac{T}{s} \log\left(\frac{\tilde{k}}{k_0}\right) & 2D \end{cases}$$

The divergences contradict the original assumption that fluctuations around the ordered state are small, and signal that the ordered phase is unstable.

This demonstrates the very general result, called the Mermin-Wagner theorem: continuous symmetries cannot be spontaneously broken in systems with sufficiently short-range interactions in dimensions $d \leq 2$ (see tutorial for more details).

On the other hand, in 3D we use $\frac{1}{e^{-\omega_k/T} - 1} = \sum_{n=1}^{\infty} e^{-n\omega_k/T}$ to write

$$\Delta m = -\int_{k_0}^{\tilde{k}} \frac{dk k^2}{(2\pi)^3} \sum_{n=1}^{\infty} \exp\left(-\frac{2nk^2 Js}{T}\right) \approx -\frac{1}{8} \left(\frac{T}{2Js\pi}\right)^{3/2} \sum_{n=1}^{\infty} \frac{1}{n^{3/2}} = -\frac{1}{8} \left(\frac{T}{2Js\pi}\right)^{3/2} \zeta\left(\frac{3}{2}\right).$$

This shows that in 3D the ferromagnetic state is stable. This remains true for higher dimensions. It is in fact a general principle that as the dimension is increased, fluctuations become less important.

5 The Mermin-Wagner theorem (Tutorial)

This tutorial focuses on the famous Mermin-Wagner theorem. Basically, what the Mermin-Wagner theorem says is that 2D systems with a continuous symmetry cannot be ordered, i.e., cannot spontaneously break that symmetry. It is a very universal result that applies, for example, to magnets, solids, superfluids, and any other system characterized by a broken continuous symmetry. It illustrates the fact that as we go to lower dimensions, fluctuations become more important, and below $D = 2$, they destroy any potential ordering.

We start by focusing on a simple model: the **classical** xy model. In this model we have a square lattice with a planar spin on each site. The Hamiltonian takes the form

$$H = -J \sum_{\langle i,j \rangle} \mathbf{s}_i \cdot \mathbf{s}_j = -J \sum_{\langle i,j \rangle} \cos(\phi_i - \phi_j).$$

The system is rotationally invariant (i.e., symmetric under $\phi_i \rightarrow \phi_i + c$). However, the energy is minimal if all the spins point at the same direction, so the ground state spontaneously breaks the symmetry.

One would naively expect a ferromagnetic phase, with a broken rotational symmetry, to survive the introduction of finite temperatures (at least for low enough temperatures). This expectation is motivated by the naive intuition that the physics at zero temperature should not be different from the physics at a nearby infinitesimal temperature. At high enough temperatures, of course, there must be a transition to a disordered phase. In 3D, this is indeed the case - there is a finite temperature βJ , where β is a dimensionless number of order 1, below which the spins point at the same direction on average (even though they may be fluctuating locally).

How do we characterize order in this system? We can define a correlation function $c(\mathbf{r} - \mathbf{r}') = \langle e^{i(\phi(\mathbf{r}) - \phi(\mathbf{r}'))} \rangle$. At zero temperature, where all the spins point at the same direction this function is 1. In an ordered system, at non-zero temperatures the ϕ s are homogenous on average and the correlation should remain non-zero even at large distances. This means we have long range order. On the other hand, if the system is disordered, distant spins become uncorrelated and we expect this function to go to 0 after some **finite** correlation length.

To see if our 2D system is ordered, we first assume it is and approximate the Hamiltonian based on this assumption. Then, we use the approximated Hamiltonian to calculate the correlation function. If the system is indeed ordered, self-consistency requires that the correlations stay non-zero. We will see that in 2D this is not the case, as the Mermin-Wagner theorem dictates.

In the first step, we say that if the system is ordered, the fluctuations between adjacent spins are small, so we can approximate $H \approx E_0 + \frac{J}{2} \sum_{\langle i,j \rangle} (\phi_i - \phi_j)^2$. Now we have a quadratic Hamiltonian, so we can actually calculate the above correlation function. Before doing that, we make another simplification by noting that if the system is ordered, at low enough temperatures the correlation length will be much larger than the lattice spacing (which is 1 in our units). In this case, we cannot “see” the lattice, so we can go to the continuum limit (small k expansion). In doing so, we rewrite the lattice theory as a field theory with the Hamiltonian

$$H \approx \frac{J}{2} \int d^2x (\nabla \phi(\mathbf{r}))^2.$$

Note that this step is actually unnecessary, as we already had a quadratic Hamiltonian, but it will simplify later computations.

First, let us decouple the Hamiltonian. As usual, this is done by going to Fourier space, and defining

$$\phi(\mathbf{r}) = \frac{1}{2\pi} \int d^2k e^{i\mathbf{k}\cdot\mathbf{r}} \phi(\mathbf{k}).$$

Plugging this into the Hamiltonian, we get

$$H = -\frac{J}{2(2\pi)^2} \int d^2r \int d^2k \int d^2k' e^{i\mathbf{k}\cdot\mathbf{r}} e^{i\mathbf{k}'\cdot\mathbf{r}} \phi(\mathbf{k}) \phi(\mathbf{k}') \mathbf{k} \cdot \mathbf{k}'.$$

By performing the integration over \mathbf{r} , we get a delta-function of the form $\delta(\mathbf{k} + \mathbf{k}')$, so we have

$$H = \frac{J}{2} \int d^2k \phi(\mathbf{k}) \phi(-\mathbf{k}) k^2 =$$

$$= \frac{1}{2} \int d^2k \epsilon(\mathbf{k}) |\phi(\mathbf{k})|^2,$$

with $\epsilon(\mathbf{k}) = Jk^2$. Note that we have used the fact that the original field $\phi(\mathbf{r})$ is real, so $\phi(-\mathbf{k}) = (\phi(\mathbf{k}))^*$. In fact, the terms for \mathbf{k} and $-\mathbf{k}$ are identical, so we can actually write this as an integral over half the plane:

$$H = \int_{k>} d^2k |\phi(\mathbf{k})|^2 \epsilon(\mathbf{k}).$$

Since we now have many decoupled degrees of freedom, we can immediately write

$$\langle \phi(\mathbf{k}) \phi(\mathbf{k}') \rangle = \frac{\int \mathcal{D}\phi \phi(\mathbf{k}) \phi(\mathbf{k}') e^{-\beta H}}{\int \mathcal{D}\phi e^{-\beta H}} = \frac{\delta(\mathbf{k} + \mathbf{k}')}{\beta \epsilon(\mathbf{k})}.$$

Now recall that we want to calculate the correlation function $c(\mathbf{r} - \mathbf{r}') = \langle e^{i(\phi(\mathbf{r}) - \phi(\mathbf{r}'))} \rangle$. Since we have a Gaussian Hamiltonian, we can immediately write

$$c(\mathbf{r} - \mathbf{r}') = e^{-1/2 \langle (\phi(\mathbf{r}) - \phi(\mathbf{r}'))^2 \rangle}.$$

To calculate the expectation value $\langle (\phi(\mathbf{r}) - \phi(\mathbf{r}'))^2 \rangle$, we write it in terms of the decoupled Fourier components

$$\begin{aligned} \langle (\phi(\mathbf{r}) - \phi(\mathbf{r}'))^2 \rangle &= \int \frac{d^2k' d^2k}{(2\pi)^2} (e^{i\mathbf{k}\cdot\mathbf{r}} - e^{i\mathbf{k}\cdot\mathbf{r}'}) (e^{i\mathbf{k}'\cdot\mathbf{r}} - e^{i\mathbf{k}'\cdot\mathbf{r}'}) \langle \phi(\mathbf{k}) \phi(\mathbf{k}') \rangle = \\ &= \frac{1}{(2\pi)^2} \int d^2k' d^2k (e^{i\mathbf{k}\cdot\mathbf{r}} - e^{i\mathbf{k}\cdot\mathbf{r}'}) (e^{i\mathbf{k}'\cdot\mathbf{r}} - e^{i\mathbf{k}'\cdot\mathbf{r}'}) \frac{\delta(\mathbf{k} + \mathbf{k}')}{\beta \epsilon(\mathbf{k})} = \\ &= \frac{1}{(2\pi)^2} \int d^2k (e^{i\mathbf{k}\cdot\mathbf{r}} - e^{i\mathbf{k}\cdot\mathbf{r}'}) (e^{-i\mathbf{k}\cdot\mathbf{r}} - e^{-i\mathbf{k}\cdot\mathbf{r}'}) \frac{1}{\beta \epsilon(\mathbf{k})} = \frac{1}{2\beta\pi^2} \int d^2k \frac{(1 - \cos(\delta\mathbf{r} \cdot \mathbf{k}))}{\epsilon(\mathbf{k})}. \end{aligned}$$

Notice that in the large δr limit, we can separate the integral into two regions, $k \lesssim \delta r^{-1}$, $k \gtrsim \delta r^{-1}$, giving a qualitatively different contribution. In the first case we have

$$\int^{1/\delta r} d^2k \frac{(1 - \cos(\delta\mathbf{r} \cdot \mathbf{k}))}{\epsilon(\mathbf{k})} \leq \int^{1/\delta r} d^2k \frac{2}{\epsilon(\mathbf{k})} \rightarrow 0,$$

so it will not be the leading order at large δr . In the second case, $k \gtrsim \delta r^{-1}$, the cosine is strongly oscillating, and will again not provide leading terms, so we neglect it. We end up with the integral

$$\frac{1}{\beta J \pi} \int_{1/\delta r} dk \frac{1}{k}.$$

Note that this integral has a logarithmic divergence at high momenta. This divergence is of course an artifact of the effective continuum model, and in the original model the lattice spacing sets a high-momentum cutoff (that is, k is restricted to the Brillouin zone). We put the cutoff back by hand, and get

$$\langle (\phi(\mathbf{r}) - \phi(\mathbf{r}'))^2 \rangle = \frac{1}{\beta J \pi} \log(\alpha \delta r),$$

where $\alpha \propto a^{-1}$ is the cutoff. Finally, putting this back in c , we get

$$c(\mathbf{r} - \mathbf{r}') \propto (\alpha \delta r)^{-\eta(T)},$$

where $\eta = \frac{T}{2\pi J}$.

This shows that the correlation between distant spins goes to zero and the system is not ordered at **any** non-zero temperature. In particular, the physics at zero-temperature is very different from the physics at an infinitesimal temperature above it. However, the way the correlation function goes to zero is different from the behavior of disordered systems. The power law correlations show a decay without a length-scale. The correlation length is actually infinite, similar to a second order phase transition. The difference is that here we are not at an isolated point in parameter space, but find this behavior for a region of parameters. We call such a phase a quasi-long-range-ordered phase.

One may think that this result is specific to the classical xy model, but it is actually quite universal. Any classical system in 2D with a continuous symmetry will have a massless field by the Goldstone theorem. The fluctuations created by

these Goldstone modes destroy the order in a similar fashion to what we have seen above - even if the corresponding Hamiltonians are much more complicated. This has been proven in very general scenarios over the years.

For example, we can study the stability of 2D classical solids: let's look at the case of a square lattice, and assign a displacement vector to each lattice point \mathbf{u}_i . Approximating the deviations of the potential from equilibrium to be harmonic, we write the energy in the form

$$\frac{K}{2} \sum_{\langle i,j \rangle} (\mathbf{u}_i - \mathbf{u}_j)^2.$$

Note the similarity of this to the form we wrote for the xy model. We can therefore immediately say that this Hamiltonian will result in the fluctuation of the form

$$\langle (\mathbf{u}_i - \mathbf{u}_j)^2 \rangle \propto T \log |i - j|.$$

This means that the relative displacement vector between two distant sites is wildly fluctuating, and the original crystal structure is unstable.

The Mermin-Wagner theorem is not special to 2D classical problems. It actually applies to various quantum problems as well. We have seen in the previous tutorial from the path integral formulation that the partition function of a quantum many body system takes the form

$$Z = \int D[\psi, \bar{\psi}] e^{-\int_0^\beta d\tau \int d^d x (\bar{\psi} \partial_\tau \psi + H[\bar{\psi}, \psi] - \mu N[\bar{\psi}, \psi])}.$$

Thinking about the Lagrangian density as an effective classical Hamiltonian density, and about the τ (time) direction as another spatial direction, we see that this partition function describes a classical $d + 1$ dimensional system which is finite in one direction (the time direction), and infinite in the d other directions. At zero-temperature, the system is infinite in the τ direction as well, so the quantum many-body problem is mapped into an infinite classical $D = d + 1$ dimensional system. This mapping is called the quantum-classical mapping.

This way, a zero-temperature quantum problem in 1D is mapped into a 2D classical problem, where the Mermin-Wagner theorem applies. This means that 1D quantum problems with a continuous symmetry cannot be ordered. A 2D quantum problem at zero-temperature is mapped onto a 3D classical problem, where order can occur. However, at finite temperatures, the system is a "thick" 2D classical system, where the Mermin-Wagner theorem should apply (if we look at large enough distances).

One last note: we have shown that the low temperature phase of the 2D xy model is quasi-long-range-ordered. It is interesting to ask whether at high temperatures a phase transition occurs between the quasi-long-range-ordered to a disordered phase. We usually associate a phase transition with a process of symmetry breaking, but here neither of the phases breaks any symmetry, so one naively expects not to find a transition. As it turns out, there is a transition, and it is called the Berezinskii-Kosterlitz-Thouless transition. Historically, it was the first example of a topological phase transition. You will study this transition extensively later in this course.

6 Path integral formulation and the Hubbard-Stratonovich transformation (Tutorial)

References: Altland & Simons Chapter 4 & 6.

6.1 Introduction

In this tutorial we have two objectives: (i) *Imaginary time coherent state path integral formalism* - to prove the identity (49). The motivation will be to show that quantum averages of many-body systems in thermal equilibrium can be computed using functional integrals over field configurations. (ii) *The Hubbard-Stratonovich transformation* - To provide a rigorous formalism in which the phenomenological Ginzburg-Landau (GL) theory can be related to an underlying microscopic theory.

6.2 Coherent state path integrals

When we study single-body problems, the particle can be described by its position operator \mathbf{q} . To get the path integral we then work in an eigen basis of this operator and calculate the propagator $\langle \mathbf{q}'t' | \mathbf{q}, t \rangle$, for example, which turns out to be related to integration over the paths $\mathbf{q}(t)$.

In field theory we have a field, i.e., a “position” operator at each point in space $\phi(x)$. We anticipate that the path integral will be related to an integration over the field configurations $\phi(x, t)$. To make sense of this, it is clear that we first need to work in a basis that diagonalizes the field operators. The states that do this are called coherent states.

To be more specific, a coherent state is an eigenstate of an annihilation operator a

$$|\psi\rangle = e^{\zeta\psi a^\dagger} |0\rangle$$

where $\zeta = 1$ ($\zeta = -1$) for Bosons (Fermions), such that $a|\psi\rangle = \psi|\psi\rangle$. Remember that our field operators are annihilation operators labeled by the spatial coordinates, so these are clearly the type of states we need in order to construct the path integral.

If we have many annihilation operators labeled by some index i (which in our case will be the spatial coordinate), we write a simultaneous eigenstate as

$$|\psi\rangle = e^{\sum_i \zeta \psi_i a_i^\dagger} |0\rangle,$$

such that $a_i |\psi\rangle = \psi_i |\psi\rangle$.

There are some crucial differences between the states corresponding to boson fields and those corresponding to fermion fields. Below we list the important properties of the two cases.

6.2.1 Bosonic coherent states

In the simpler case a describes a bosonic degree of freedom and ψ is simply a c-number. We will make use of three basic identities: first the overlap between two coherent states

$$\langle \psi_1 | \psi_2 \rangle = e^{\bar{\psi}_1 \psi_2}. \quad (46)$$

The second is the resolution of identity which follows directly from (46)

$$1 = \int d\bar{\psi} d\psi e^{-\bar{\psi}\psi} |\psi\rangle \langle \psi| \quad (47)$$

Here we use the notation that ψ is a vector with a discrete set of components ψ_i corresponding to the underlying Fock space. When studying a field theory in the continuum limit, this will be $\psi(x)$. In the general case the above notations mean $\bar{\psi}\psi \equiv \sum_i \bar{\psi}_i \psi_i$ and $d\bar{\psi}d\psi \equiv \prod_i \frac{d\bar{\psi}_i d\psi_i}{\pi}$. Finally, the third identity is the Gaussian integral of the complex variables ψ and $\bar{\psi}$

$$\int d\bar{\psi} d\psi e^{-\bar{\psi} A \psi} = \frac{1}{|A|}$$

where A is a matrix with a positive definite Hermitian part.

6.2.2 Fermionic coherent states

If the operator a describes a fermionic field things become a bit more complicated. To see this, let us assume again that $|\psi\rangle$ is an eigen state such that $a_i |\psi\rangle = \psi_i |\psi\rangle$. The only way to make this consistent with the anti-commutation relations between different a 's is to demand that different ψ 's anti-commute as well. We therefore need special numbers that anti-commute. These are known as Grassmann numbers, and they satisfy:

$$\psi_i \psi_j = -\psi_j \psi_i.$$

The operation of integration and differentiation with these numbers are defined as follows

$$\int d\psi = 0; \int d\psi \psi = 1$$

and $\partial_\psi \psi = 1$.

The overlap between two coherent states and the resolution of identity remain in the form of (46) and (47). The Gaussian integral on the other hand is significantly different

$$\int d\bar{\psi} d\psi e^{-\bar{\psi} A \psi} = |A| \quad (48)$$

where A can be any matrix.

6.2.3 Derivation of the path integral

In what follows we will prove the central identity

$$Z = \text{Tr} e^{-\beta(\hat{H} - \mu\hat{N})} = \int D[\psi, \bar{\psi}] e^{-\int_0^\beta d\tau (\bar{\psi} \partial_\tau \psi + H[\bar{\psi}, \psi] - \mu N[\bar{\psi}, \psi])}. \quad (49)$$

where H and N are the Hamiltonian and particle number respectively and $\psi, \bar{\psi}$ are c-numbers (Grassmann numbers) in the case that the particles have Bosonic (Fermionic) mutual statistics, assigned to each point of space and "time" τ . The boundary conditions of this path integral is $\psi(0) = \zeta \psi(\beta)$ and $\bar{\psi}(0) = \zeta \bar{\psi}(\beta)$.

As mentioned above, our motivation will be computing expectation values of quantum many-body systems in thermal equilibrium. For example, if we have an operator $A[a, a^\dagger]$, its expectation value will be

$$\langle \hat{A} \rangle = \frac{1}{Z} \int D[\psi, \bar{\psi}] A[\psi, \bar{\psi}] e^{-\int_0^\beta d\tau (\bar{\psi} \partial_\tau \psi + H[\bar{\psi}, \psi] - \mu N[\bar{\psi}, \psi])}.$$

Let start with the definition of the trace

$$Z = \text{Tr} e^{-\beta(\hat{H} - \mu\hat{N})} = \sum_n \langle n | e^{-\beta(\hat{H} - \mu\hat{N})} | n \rangle \quad (50)$$

Notice that each term in this sum is the probability amplitude of finding the the system at the same Fock state it started in, i.e. $|n\rangle$, after a time $t = i\hbar\beta$, which, as you know, can be written as a Feynman path integral. In the first step we will want to get rid of the summation over n . To do so we insert the resolution of identity (47) into equation (50)

$$Z = \int d\bar{\psi} d\psi e^{-\bar{\psi} \psi} \sum_n \langle n | \psi \rangle \langle \psi | e^{-\beta(\hat{H} - \mu\hat{N})} | n \rangle$$

We can sum over n using the resolution of identity $1 = \sum_n |n\rangle \langle n|$ but we first need to commute $\langle n | \psi \rangle$ with $\langle \psi | e^{-\beta(\hat{H} - \mu\hat{N})} | n \rangle$. In the case of bosonic particles this is just a number and it commutes with anything. In the case of fermions Grassmann numbers are involved and we need to be more careful. If we expand the matrix elements in terms of the Grassmann variables, we find an additional sign:

$$Z = \int d\bar{\psi} d\psi e^{-\bar{\psi} \psi} \langle \zeta \psi | e^{-\beta(\hat{H} - \mu\hat{N})} | \psi \rangle \quad (51)$$

Now let us continue to the second step: we divide the imaginary-time evolution operator into M small steps

$$e^{-\beta(\hat{H}-\mu\hat{N})} = \left(e^{-\delta(\hat{H}-\mu\hat{N})} \right)^M$$

where $\delta = \beta/M$. In the third step we insert M resolutions of identity in the expectation value in equation (51)

$$\begin{aligned} \langle \zeta\psi | [e^{-\delta(\hat{H}-\mu\hat{N})}]^M | \psi \rangle &= \int \prod_{m=1}^M d\bar{\psi}^m d\psi^m e^{-\sum_m \bar{\psi}^m \psi^m} \times \\ \langle \zeta\psi | \psi^M \rangle \langle \psi^M | e^{-\delta(\hat{H}-\mu\hat{N})} | \psi^{M-1} \rangle &\dots \langle \psi^2 | e^{-\delta(\hat{H}-\mu\hat{N})} | \psi^1 \rangle \langle \psi^1 | e^{-\delta(\hat{H}-\mu\hat{N})} | \psi \rangle \end{aligned} \quad (52)$$

Expanding in small δ , we have

$$\begin{aligned} \langle \psi^{m+1} | e^{-\delta(\hat{H}-\mu\hat{N})} | \psi^m \rangle &\approx \langle \psi^{m+1} | 1 - \delta (\hat{H} - \mu\hat{N}) | \psi^m \rangle \\ &= \langle \psi^{m+1} | \psi^m \rangle (1 - \delta (H[\bar{\psi}^{m+1}, \psi^m] - \mu N[\bar{\psi}^{m+1}, \psi^m])) \\ &\approx e^{\bar{\psi}^{m+1} \psi^m - \delta (H[\bar{\psi}^{m+1}, \psi^m] - \mu N[\bar{\psi}^{m+1}, \psi^m])}, \end{aligned}$$

where we have defined $H[\bar{\psi}^{m+1}, \psi^m] = \frac{\langle \psi^{m+1} | \hat{H} | \psi^m \rangle}{\langle \psi^{m+1} | \psi^m \rangle}$.

Now if we insert this expression in (51) we get

$$Z = \int \prod_{m=0}^M d\bar{\psi}^m d\psi^m e^{-\delta \sum_{m=0}^M \left[\left(\frac{\bar{\psi}^m - \bar{\psi}^{m+1}}{\delta} \right) \psi^m + H[\bar{\psi}^{m+1}, \psi^m] - \mu N[\bar{\psi}^{m+1}, \psi^m] \right]}$$

with $\psi^0 = \zeta\psi^{M+1} = \psi$. Finally, in the fourth step we take $M \rightarrow \infty$ and obtain

$$Z = \int D[\psi, \bar{\psi}] e^{-\int_0^\beta d\tau (\bar{\psi} \partial_\tau \psi + H[\bar{\psi}, \psi] - \mu N[\bar{\psi}, \psi])}$$

where

$$D[\bar{\psi}, \psi] \equiv \lim_{M \rightarrow \infty} \prod_{m=0}^M d\bar{\psi}^m d\psi^m$$

The integration is to be carried over fields satisfying $\psi(\beta) = \zeta\psi(0)$. It is very important to note that by neglecting the time derivative term we resume to the classical integration over configurations of the fields ψ and $\bar{\psi}$. Indeed the time derivative term takes into account the effects of the non-trivial (anti-) commutation between a_i and a_i^\dagger which have now been transferred to fields ψ_i and $\bar{\psi}_i$ which always have trivial (anti-) commutation relations.

To be more specific, we usually discuss an interacting Hamiltonian of the form

$$S = \int_0^\beta d\tau \left[\sum_{ij} \bar{\psi}_i [(\partial_\tau - \mu) \delta_{ij} + h_{ij}] \psi_j + \sum_{ijkl} V_{ijkl} \bar{\psi}_i(\tau) \bar{\psi}_j(\tau) \psi_k(\tau) \psi_l(\tau) \right]$$

To compute path integrals we usually transform to the Fourier basis where the derivative operators are diagonal. This procedure applies also for the imaginary time

$$\psi(\tau) = \frac{1}{\sqrt{\beta}} \sum_\nu \psi(\nu) e^{-i\nu\tau}$$

in which case the action takes the form

$$\begin{aligned} S &= \sum_{n, ij} \bar{\psi}_{in} [(-i\nu_n - \mu) \delta_{ij} + h_{ij}] \psi_{jn} + \\ &+ \frac{1}{\beta} \sum_{ijkl, n_i} V_{ijkl} \bar{\psi}_{in_1} \bar{\psi}_{jn_2} \psi_{kn_3} \psi_{ln_4} \delta_{n_1+n_2, n_3+n_4}. \end{aligned}$$

To obey the boundary conditions $\psi(0) = \zeta\psi(\beta)$ we choose the following frequencies in the wave functions $e^{-i\nu\tau}$

$$\nu_n = \begin{cases} \frac{2n\pi}{\beta} & \text{Bosons} \\ \frac{(2n+1)\pi}{\beta} & \text{Fermion} \end{cases}$$

These imaginary-time frequencies are known as *Matsubara frequencies*. Summing over them is a whole story to itself. You will see an example in the exercise. I want to note that in the limit of zero temperature ($\beta \rightarrow \infty$) the sum becomes a simple integral $\frac{1}{\beta} \sum \nu_n \rightarrow \int_{-\infty}^{\infty} \frac{d\nu}{2\pi}$.

6.3 The Hubbard-Stratonovich transformation

In this tutorial we will learn a general method to relate a Ginzburg-Landau theory to the underlying microscopic theory. For example let us consider the GL theory of a ferromagnet

$$F_{GL} = \int d^3x [-\alpha \mathbf{m} \nabla^2 \mathbf{m} + am^2 + \beta m^4].$$

Here, if $a < 0$ a transition to a ferromagnetic state may occur.

To see how to relate this theory to an underlying microscopic theory let us consider an interacting model of fermions

$$Z = \int D[\bar{\psi}, \psi] e^{-S}$$

$$S = \int_0^\beta d\tau d^3x \left[\sum_{s=\uparrow\downarrow} \bar{\psi}_s \left(\partial_\tau - \frac{\nabla^2}{2m} - \mu \right) \psi_s + g \bar{\psi}_\uparrow \bar{\psi}_\downarrow \psi_\downarrow \psi_\uparrow \right] \quad (53)$$

Notice that the local interactions may be reorganized in the following manner

$$\bar{\psi}_\uparrow(x) \bar{\psi}_\downarrow(x) \psi_\downarrow(x) \psi_\uparrow(x) = -\mathbf{s}(x) \cdot \mathbf{s}(x)$$

where $\mathbf{s}(x) = \frac{1}{2} \bar{\psi}_s \boldsymbol{\sigma}_{ss'} \psi_{s'}$ and thus the action is equivalently given by

$$S = \int_0^\beta d\tau d^3x \left[\sum_{s=\uparrow\downarrow} \bar{\psi}_s \left(\partial_\tau - \frac{\nabla^2}{2m} - \mu \right) \psi_s - g \mathbf{s} \cdot \mathbf{s} \right] = \quad (54)$$

Now we will employ the Hubbard-Stratonovich transformation which relies on the following identity

$$\int D[\mathbf{m}] \exp \left[- \int_0^\beta d\tau d^3x (m^2 - 2\mathbf{m} \cdot \mathbf{s}) \right] \quad (55)$$

$$= \underbrace{\int D[\mathbf{m}] \exp \left[- \int_0^\beta d\tau d^3x (\mathbf{m} - \mathbf{s})^2 \right]}_N \exp \left[\int_0^\beta d\tau d^3x \mathbf{s}^2 \right] \quad (56)$$

$$= N \exp \left[\int_0^\beta d\tau d^3x \mathbf{s}^2 \right], \quad (57)$$

where N does not depend on the field \mathbf{s} . Thus, equation (53) may be equivalently written as follows

$$Z = \frac{1}{N} \int D[\bar{\psi}, \psi, \mathbf{m}] e^{-S_{HS}} \quad (58)$$

where

$$S_{HS} = \int_0^\beta d\tau d^3x \left[\sum_{s=\uparrow\downarrow} \bar{\psi}_s \left(\partial_\tau - \frac{\nabla^2}{2m} - \mu \right) \psi_s - 2g \mathbf{m} \cdot \mathbf{s} + g m^2 \right]$$

Notice that the action above resembles a mean-field decoupling of the interaction term. To see this substitute $\mathbf{s} = \mathbf{M} + \delta\mathbf{s}$ in the interaction term, where \mathbf{M} is the mean-field, and neglect terms of order $O(\delta s^2)$

$$\mathbf{s} \cdot \mathbf{s} = (\mathbf{M} + \delta\mathbf{s})(\mathbf{M} + \delta\mathbf{s}) \approx 2\mathbf{M} \cdot \mathbf{s} - M^2$$

However, there is a crucial difference: \mathbf{M} is a mean-field with a single value whereas the field \mathbf{m} fluctuates and we integrate over all possible paths of this field. Actually, equation (58) is exact, we made no approximations in deriving it. As you will see in the exercise the saddle point approximation of this theory gives the self-consistent mean-field approximation obtained from a variational method. This observation suggests that the field \mathbf{m} , introduced by some formal manipulations, may be interpreted as a local magnetization field.

Finally, let us discuss how we can use the HS theory (58) to obtain an effective theory for the magnetization field \mathbf{m} . The standard way is to integrate over the Fermions. Since the \mathbf{m} -field interacts with the fermions, their integration will generate terms containing the \mathbf{m} field. First let us rewrite the theory as follows

$$S_{HS} = \int_0^\beta d\tau d^3x \left[\sum_{s=\uparrow\downarrow} \bar{\psi}_s \left(\underbrace{\left(\partial_\tau - \frac{\nabla^2}{2m} - \mu \right)}_{G^{-1}} \delta_{ss'} - \underbrace{g\mathbf{m} \cdot \boldsymbol{\sigma}_{ss'}}_X \right) \psi_{s'} + gm^2 \right]$$

Formally, the fermionic part of the path integral has the quadratic form

$$\int d\bar{\psi} d\psi e^{-\bar{\psi} A \psi},$$

where $A = G^{-1} - X[\mathbf{m}]$. Thus using (48) we can perform the integral over the fermions which gives

$$Z = \frac{1}{N} \int D[\mathbf{m}] |A| e^{-gm^2} = \frac{1}{N} \int D[\mathbf{m}] e^{-gm^2 + \log|A|} = \frac{1}{N} \int D[\mathbf{m}] e^{-gm^2 + \text{Tr} \log A}$$

The trace of the logarithm can be expanded perturbatively in small X in the following manner:

$$\begin{aligned} \text{Tr} \log A &= \text{Tr} \log (G^{-1} - X) = \text{Tr} \log G^{-1} + \text{Tr} \log (1 - GX) = \\ &= \text{Tr} \log G^{-1} + \text{Tr} \left[-GX + \frac{1}{2} GXGX + \dots \right] \end{aligned}$$

Now since X is linear in m each order gives the corresponding order in the Ginzburg-Landau theory. The first order vanishes, as can be anticipated on symmetry grounds. The second order term, if expanded in momentum basis, gives the quadratic term

$$\frac{1}{2} \text{Tr} [GXGX] = \frac{g^2}{\beta\Omega} \sum_{\mathbf{q}, \omega} \Pi(\mathbf{q}, \omega) \mathbf{m}_{\mathbf{q}}(\omega) \mathbf{m}_{-\mathbf{q}}(-\omega),$$

where

$$\Pi = \frac{1}{\beta\Omega} \sum_{\mathbf{k}\nu} \frac{1}{-i\nu + \frac{k^2}{2m} - \mu} \cdot \frac{1}{-i(\nu + \omega) + \frac{(\mathbf{k} + \mathbf{q})^2}{2m} - \mu},$$

and we have used the fact that G is diagonal in spin space and that the Pauli matrices are traceless. We can expand this in small \mathbf{q} and get the parameters of the Ginzburg-Landau theory:

$$a = g - \Pi(0, 0),$$

and

$$\alpha = \frac{1}{2} \left(\frac{\partial^2 \Pi(\mathbf{q}, 0)}{\partial q^2} \right) \Big|_{q=0}.$$

Of course β will be derived from a higher order term with four powers of X .

7 Superfluid (Based on Ref. [1])

7.1 Symmetry (Global Gauge symmetry)

We consider a model described by

$$H = \int dr a^\dagger(r) \left(\frac{p^2}{2m} - \mu \right) a(r) + \frac{u}{2} (a^\dagger(r)a(r))^2$$

and we write the partition function as an auxiliary field path integral:

$$Z = \text{Tr} (e^{-\beta H}) = \int D\psi D\bar{\psi}^{-S(\psi, \bar{\psi})}$$

where $S(\bar{\psi}, \psi) = \int_0^\beta d\tau \int d^3r \left[\bar{\psi}(r, \tau) \left(\partial_\tau - \frac{1}{2m} \nabla^2 - \mu \right) \psi(r, \tau) + \frac{u}{2} (\bar{\psi}(r, \tau) \psi(r, \tau))^2 \right]$. Recall that in deriving the path integral, the ψ -fields were defined as the eigenvalues of the corresponding coherent states:

$$\psi |\psi\rangle = a |\psi\rangle, |\psi\rangle = e^{-\sum \psi a^\dagger} |0\rangle.$$

We have a **global** U(1) symmetry $\psi \rightarrow e^{-i\varphi} \psi$.

From Noether's theorem we have a conserved current

$$J_\mu = \frac{\delta S}{\delta (\partial_\mu \bar{\psi})} \frac{\partial \bar{\psi}}{\partial \varphi} + \frac{\delta S}{\delta (\partial_\mu \psi)} \frac{\partial \psi}{\partial \varphi},$$

giving (using the relation $\partial \bar{\psi} / \partial \phi = i \bar{\psi}$)

$$J_i = -\frac{1}{2mi} (\bar{\psi} \nabla_i \psi - \psi \nabla_i \bar{\psi}).$$

The conserved charge is an integral over

$$J_0 = \frac{\delta S}{\delta \dot{\psi}} i \dot{\psi} = \bar{\psi} \dot{\psi} = \rho.$$

Noether theorem itself gives the continuity equation $\partial_\mu j^\mu = \dot{\rho} - \vec{\nabla} \cdot \vec{J} = 0$, meaning the number of particles is conserved. Thus, the above U(1) symmetry is associated with charge conservation.

7.2 The Bose-Einstein condensation

We consider first the case $u = 0$ so that $H \rightarrow H_0 = \int dr a^\dagger(r) \left(-\frac{\nabla^2}{2m} - \mu \right) a(r)$.

Matsubara frequencies

To represent the free partition function it is useful to use the imaginary (Matsubara) frequency using the relation:

$$\psi(\tau, r) = \frac{1}{\sqrt{\beta}} \sum_n e^{-i\omega_n \tau} \psi_n(r), \quad \psi_n(r) = \frac{1}{\sqrt{\beta}} \int d\tau e^{i\omega_n \tau} \psi(r, \tau)$$

with

$$\bar{\psi}(\tau, r) = \frac{1}{\sqrt{\beta}} \sum_n e^{i\omega_n \tau} \bar{\psi}_n(r), \quad \bar{\psi}_n(r) = \frac{1}{\sqrt{\beta}} \int d\tau e^{i\omega_n \tau} \bar{\psi}(r, \tau)$$

$$\omega_n = 2\pi nT \text{ for bosons, } \omega_n = 2\pi \left(n + \frac{1}{2} \right) T \text{ for fermions}$$

ensuring periodic and anti-periodic boundary conditions in τ for boson and fermion respectively.

Using the Matsubara presentation for $\psi(r, \tau)$ and the relation $\int_0^\beta e^{-i\omega_n \tau} d\tau = \beta \delta_{\omega_n, 0}$ we have $\int_0^\beta d\tau \bar{\psi}(r, \tau) \partial_\tau \psi(r, \tau) = \sum_{\omega_n=2\pi n} \bar{\psi}_n(r) (-i\omega_n) \psi_n(r)$. If we further diagonalize the Hamiltonian and develop the field in terms of the eigenfunction ϕ_k , i.e., $\psi_n(r) = \sum_k \phi_k \psi_{kn}$ we can write the partition function Z in terms of the Fourier field ψ_{kn}

$$Z = \int D\bar{\psi} D\psi \exp[-S(\bar{\psi}, \psi)] = \int \prod_{nk} \bar{\psi}_{kn} \psi_{kn} \exp\left(-\beta \sum_{kn} \bar{\psi}_{kn} (-i\omega_n + \xi_k) \psi_{kn}\right) = \prod_k \prod_n \frac{1}{\beta(-i\omega_n + \xi_k)}$$

with $\xi_k = \frac{k^2}{2m} - \mu = \epsilon_k - \mu$. Stability of these integrals demands $\mu \leq 0$. Using the thermodynamic relation for $N(\mu)$ we find

$$N(\mu) = -T \frac{\partial}{\partial \mu} \log Z = -T \frac{\partial}{\partial \mu} \sum_{n,k} \log\left(\frac{-i\omega_n + \xi_k}{T}\right) = T \sum_{n,k} \frac{1}{i\omega_n - \epsilon_k + \mu}. \quad (59)$$

Knowing that this is a non-interacting problem, we expect N to be $\sum_k \frac{1}{e^{\beta(\epsilon_k - \mu)} - 1}$, and indeed we can see that this function has poles at $\beta(\epsilon_k - \mu) = 2\pi ni$, similar to 59 (since $\omega_n = 2\pi nT$). Hence the two functions have the same poles, hinting that they represent the same function. Contour integration with a few beautiful tricks (see for example Altland Simons page 170) shows that indeed:

$$T \sum_n \frac{1}{i\omega_n - \epsilon_k + \mu} = \frac{1}{e^{\beta(\epsilon_k - \mu)} - 1} \equiv n_B(\xi_k).$$

For a fixed external number of particles N the equation

$$N \equiv N[\mu(T)]$$

is an equation for the chemical potential as a function of the temperature T . In three dimensions we can write this equation as

$$N(\mu) = \sum_k n_B(\xi_k) = \Omega \frac{1}{\Omega} \sum_k n_B(\xi_k) = \Omega \frac{1}{(2\pi)^3} \int d^3k n_B(\xi_k) = \Omega \frac{1}{2\pi^2} \int dk k^2 n_B(\xi_k) = \frac{\Omega \text{Li}_{\frac{3}{2}}(e^{\beta\mu})}{2\sqrt{2}\pi^{3/2}(\beta m)^{3/2}}$$

with Ω being the system volume. Importantly to satisfy the equation $N(\mu) = N$ we must increase μ as we lower the temperature until at $\mu = 0$ we have

$$N(0) = \Omega c \frac{1}{\lambda_T^3}$$

with

$$\lambda_T = \frac{1}{\sqrt{mT}}$$

known as the particle thermal length and a numerical factor $c = \frac{\zeta(\frac{3}{2})}{(2\pi)^{3/2}} = 0.165869$. If we go below the temperature for which $N(0) = \Omega c \frac{1}{\lambda_T^3} = N$, we can not longer satisfy the equation $N \equiv N[\mu(T)]$. This means that a macroscopic number of particle N_0 must occupy the ground state. We call such a phase a Bose-Einstein condensate. Notice that it occurs at the temperature for which the average distance between the particles $1/n^{1/3} = (\Omega/N)^{1/3} \approx 0.54\lambda_T$ is of the order of the thermal length. This gives

$$T_c = \frac{(cn)^{2/3}}{m} = 0.3 \frac{n^{2/3}}{m}.$$

This gives a prediction: T_c increases for lighter particles and denser materials!

Below T_c we can write the action in terms of the field ψ_0 corresponding to the ground state. We identify the number of particles in the ground state as

$$N_0 = \bar{\psi}_0 \psi_0,$$

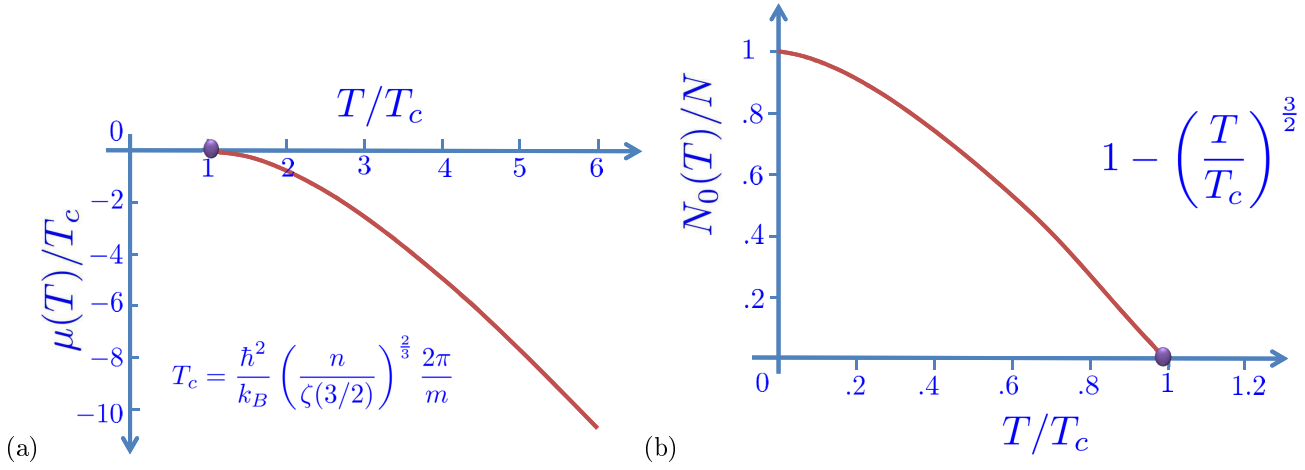

Figure 7: (a) The chemical potential μ as a function of the temperature T . (b) The number of bosons in the ground state.

and write the action

$$S = \bar{\psi}_0 \beta \mu \psi_0 + \sum_{k \neq 0} \bar{\psi}_{kn} (-i\omega_n + \varepsilon_k - \mu) \psi_{kn}.$$

Notice that the imaginary time derivative $\partial_\tau \rightarrow -i\omega_n$ does not appear in the first term, this is already an approximation. In the formulation of the path integral the derivative in imaginary time appeared due to the commutation relation of the operators, neglecting them meaning that we omit quantum effects. In our case it is justified to perform this semiclassical approximation for the operator a_0 since $a_0^\dagger a_0 \approx N \gg 1$ while the commutation relations are $[a_0^\dagger, a_0] = 1$. So that in the first term we take into consideration only the thermal fluctuations (zero Matsubara frequency). In the second term, on the other hand, quantum fluctuations are included (We note that the Ginsburg-Landau theory in fact neglects the quantum fluctuations).

Using the action S we can write the particle number as

$$\begin{aligned} N &= -\partial_\mu F = \bar{\psi}_0 \psi_0 + T \sum_{nk} \frac{1}{i\omega_n - \varepsilon_k} = \bar{\psi}_0 \psi_0 + \frac{\Omega}{(2\pi)^3} \int d^3k \frac{1}{e^{\beta k^2/2m} - 1} \\ &= \bar{\psi}_0 \psi_0 + \left(\frac{mT}{2\pi}\right)^{3/2} \zeta\left(\frac{3}{2}\right) = N_0 + N \left(\frac{T}{T_c}\right)^{3/2}. \end{aligned}$$

In 3D this gives us

$$\frac{N_0}{N} = \left(\frac{T_c - T}{T_c}\right)^{3/2}$$

We found a propagator

$$G(k, i\omega_n) = \langle \bar{\psi}(k, \omega) \psi(k, \omega) \rangle = \frac{1}{-i\omega_n + \varepsilon_k}$$

from which we can find the spectrum by analytic continuation, where we get poles at energy eigenvalues:

$$G^r(k, \omega) = G(k, i\omega_n \rightarrow \omega + i\delta) = \frac{1}{\omega - \varepsilon_k + i\delta}$$

$$Im(G^r) = \pi \delta(\omega - \varepsilon_k)$$

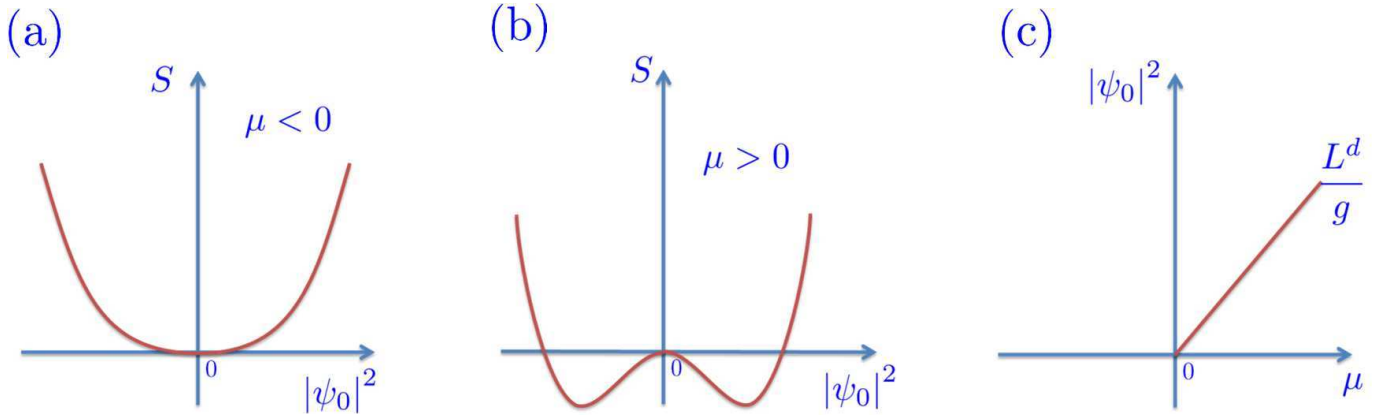

Figure 8: (a) The action S for $\mu < 0$ at the minimum $|\psi_0|^2 = 0$. (b) The action S for $\mu > 0$. (c) The number of boson in the condensate $N_0 = |\psi_0|^2$.

7.3 Weakly Interacting Bose Gas

We now study the effects of weak interactions of the above non-interacting picture.

7.3.1 Mean Field Solution

We look at the action of the wave function ψ_0 which describes the classical part of the wave function of the BEC.

$$TS(\bar{\psi}_0, \psi_0) = -\mu\bar{\psi}_0\psi_0 + \frac{g}{2L^d} (\bar{\psi}_0\psi_0)^2.$$

Notice that we take into consideration only the classical part of ψ (we assume that it does not depend on τ). Recall that this is justified because $N_0 = \bar{\psi}_0\psi_0 \gg 1$ and the commutation relation of the correspond operators is $[a^\dagger, a] = 1$.

The corresponding partition function is $Z = \int d\bar{\psi}_0 d\psi_0 e^{-TS(\bar{\psi}_0, \psi_0)}$. For $T \ll \mu$ we evaluate Z via the saddle point approximation, giving us the equations of motion:

$$\frac{\delta S}{\delta \bar{\psi}_0} = 0 \Rightarrow \bar{\psi}_0 \left(-\mu + \frac{g}{L^d} (\bar{\psi}_0\psi_0) \right) = 0,$$

with

$$|\psi_0| = \sqrt{\frac{\mu L^d}{g}}.$$

Notice that the total number of particle in the condensate $\bar{\psi}_0\psi_0$ is proportional to the volume L^d as it should be. Due to the interaction term g we no longer have a condition on the sign of μ , and the transition occurs at $\mu = 0$. In the interacting case, we find that the number of the particles in the condensate is proportional to μ .

7.3.2 Goldstone Modes

Notice that in the ground state $|\psi_0|^2 \neq 0$. This forces ψ_0 to have a well defined phase, thus spontaneously breaking the $U(1)$ symmetry of the problem. As we saw for magnetic systems, since we have a continuous symmetry, we expect to find gapless excitations due to the Goldstone theorem.

We will find now the Goldstone modes of the system, to do so we define the average condensate density

$$\rho_0 = \frac{\bar{\psi}_0\psi_0}{L^d}$$

Allowing for spatial and temporal fluctuations, the field ψ_0 is given by:

$$\psi = \sqrt{\rho_0 + \rho(r, t)} e^{i\phi(r, t)}.$$

The amplitude of the fluctuations is given by $\rho(r, t)$ and the phase of the condensate is $\phi(r, t)$.

Substituting in the action, we find:

$$S = \int d\tau d^d r \bar{\psi} \left[\left(\partial_\tau - \frac{\nabla^2}{2m} \right) \psi + \frac{1}{2} g |\psi|^2 (|\psi|^2 - 2\rho_0) \right]$$

this is equivalent to the action discussed above with $\rho_0 g = \mu$, where we have added terms which depends on derivatives with respect to time and space to account for the fluctuations. Assuming now that $\rho(r, t) \ll \rho_0$ and expanding the action we have

$$S \approx \int_0^\beta d\tau d^d r \left[i\rho_0 \dot{\phi} + \underline{i\rho \dot{\phi}} + \frac{\rho_0}{2m} (\phi')^2 + \frac{\rho'^2}{8m\rho_0} + \frac{u}{2} \rho^2 \right] + O(\rho^3, (\nabla\phi)^3)$$

In analogy to the Lagrangian of a single particle $L = p\dot{q} - H$, where p and q are conjugate variables satisfying $[p, q] = i$, the underlined terms in S helps us identify ϕ and ρ as conjugate variables. We therefore expect, in the operator (canonical) formulation, to get

$$[\phi, \rho] = \delta(x - x').$$

We want to integrate over the ρ part to obtain an effective action for ϕ , the Goldstone mode.

For one variable we have

$$S = \int d\tau \left(ip\partial_\tau q - \frac{p^2}{2m} - V(q) \right)$$

integrating over p gives

$$\int d\tau \frac{m(\partial_\tau q)^2}{2} - V(q).$$

In our case we first go to Fourier space and then perform the functional integral over ρ , giving us

$$S = \int_0^\beta d\tau \frac{d^d k}{(2\pi)^d} \left[i\rho_0 \dot{\phi}_0 + \frac{\rho_0}{2m} k^2 \phi_k \phi_{-k} + \frac{1}{2g(1+k^2\xi^2)} \dot{\phi}_k \dot{\phi}_{-k} \right]$$

$$\xi = 4mg\rho_0.$$

For $k\xi \ll 1$ we can easily transform back to real space, and we get the effective action

$$S = \int_0^\beta d\tau d^d r \left[i\rho_0 \partial_\tau \phi + \frac{1}{2u} (\partial_\tau \phi)^2 + \frac{\rho_0}{2m} (\nabla\phi)^2 \right] \quad (\text{valid for } r \gg \xi).$$

This is a continuum XY model. The name XY originates from the fact that the order parameter ψ is a complex function that can be represented by a real and imaginary part i.e. a planar vector that "lives" in an XY plane.

Examining the action, it seems identical to the quadratic action we always had, with one important difference: ϕ is now a compact angle: $\phi + 2\pi = \phi$. An implication of that is that to fully describe the theory, we need to consider vortices: 2D solutions in which the phase completes an integer number of windings as we wind around some point in space (see Fig. 14). An example of such a solution is $\phi(x, y) = n \arctan\left(\frac{y-y_0}{x-x_0}\right)$. Such a solution is interesting because of it's topological

stability: a vortex configuration cannot be locally deformed into a uniform configuration. In more general terms, these are examples of topological defects. We will elaborate on vortices later.

A common definition is the superfluid density:

$$\rho_s = \frac{\rho_0}{m}$$

which determines the energetic cost of deforming the condensate phase in space, and a compressibility

$$\kappa = \frac{1}{g}$$

which determines the cost of phase changes in time. Transforming to q, ω space we get

$$S = \frac{1}{2} \sum_{q, \omega} (\kappa \omega^2 + \rho_s q^2) \phi_{q\omega} \phi_{-q-\omega},$$

indicating that the dispersion is

$$\omega_q = cq \Rightarrow c = \sqrt{\rho_s / \kappa} = \sqrt{\frac{\rho_0 g}{m}}.$$

Reminder: we assume $|r| \gg \xi$, meaning we have performed coarse graining.

7.4 Superfluidity

To discuss superfluidity let us add an external chemical potential μ_{ext} to the system. Working in the canonical formulation, we write the Hamiltonian as

$$H = \frac{1}{2} \int dx \left[\rho_s (\nabla \phi)^2 + \frac{1}{\kappa} \rho^2 - \mu_{\text{ext}} \rho \right].$$

Recall, now ρ and ϕ should be understood as operators satisfying

$$[\phi(x), \rho(x')] = \delta(x - x').$$

The current operator is

$$J = \frac{1}{2mi} (\bar{\psi} \nabla \psi - \psi \nabla \bar{\psi}) = \frac{\rho(r, t)}{m} \nabla \phi \approx \frac{\rho_0}{m} \nabla \phi = \rho_s \nabla \phi.$$

The Hamilton equations are

$$\frac{\partial \rho}{\partial t} = -\frac{\partial H}{\partial \phi} = -\rho_s \nabla^2 \phi = -\nabla \cdot J$$

which is the expected continuity equation. The more interesting equation is

$$\frac{\partial \phi}{\partial t} = \frac{\partial H}{\partial \rho} = \mu_{\text{ext}} - u\rho \equiv \mu(r, t).$$

This is one of the Josephson relations - the time derivative of the phase depends linearly on an external potential.

To see how this system exhibits superfluidity let assume that $\phi = qx$ then we have

$$J = \frac{\rho_0}{m} \nabla \phi = q \frac{\rho_0}{m} \hat{x}$$

and the phase vector in x space looks like this:

The surprising thing is that such a current is stable, since we have Goldstone modes (low energy excitations) in the system we could have expected that such a current would excite them.

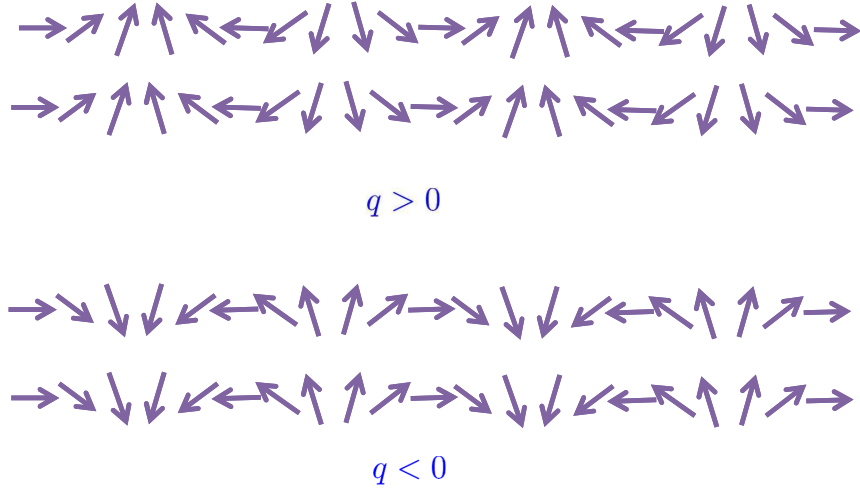

Figure 9: Phase evolution in the presence of current

7.5 Landau's Argument

A fluid moving uniformly in the lab frame without internal excitations has an energy $E_0 = \frac{1}{2}mv^2$. In viscous fluids, due to friction with the wall, the fluid will lose its kinetic energy. Such a dissipative process takes place through the creation of excitations in the fluid. In case we have excitations they will move with the system.

We start by considering the system in its ground state, and moving to the center of mass frame, where there is no kinetic energy. If excitations are introduced, the entire energy of the system is their energy $\epsilon(p) = c \cdot p$. We now use the Galilean transformation to go back to the lab frame, where the walls are at rest. We get the energy

$$E_1 = \frac{1}{2}mv^2 + \vec{p} \cdot \vec{v} + \epsilon(p)$$

(the $\vec{p} \cdot \vec{v}$ term is from moving the excitations, just from moving something with momentum p with a velocity v)

To have dissipation, it must be energetically favorable to create excitations. Therefore, if we want to have dissipation as a result of excitations, we must have $E_1 - E_0 < 0 \Rightarrow \vec{p} \cdot \vec{v} + \epsilon(p) = \vec{p} \cdot \vec{v} + \vec{c} \cdot \vec{p} < 0$ which requires $|\vec{v}| > c$. This means that for low speeds this doesn't hold and there is no dissipation. The fact that we have a linear dispersion relation means that there is a range of velocities for which the system is non-dissipative. Usually we have a quadratic dispersion relation which means we can always excite the system.

7.6 Various Consequences

7.6.1 Quantization of Circulation

Considering

$$J = \frac{\rho_0}{m} \nabla \phi$$

we integrate over a closed path

$$\oint \nabla \phi = \phi(L) - \phi(0) = \phi(2\pi) - \phi(0)$$

and since ϕ is compact ($\psi = \rho e^{i\phi}$) we require

$$\oint \nabla \phi = 2\pi n$$

$$\Rightarrow \int v \cdot dl = \int \frac{J}{\rho_0} \cdot dl = \frac{\hbar}{m} 2\pi n = \frac{\hbar n}{m}$$

where we reintroduced \hbar . We have a quantization of superfluid velocity.

7.6.2 Irrotational flow

Due to the relation $J = \rho_s \nabla \phi$, the flow is irrotational:

$$\nabla \times J = \rho_s \nabla \times \nabla \phi = 0 \quad (60)$$

7.6.3 Vortices

A vortex solution is a singular ϕ configuration, which violates Eq. 60. We take

$$\phi = n\theta, n \in \mathbb{Z}.$$

where $\theta = \arctan(\frac{x}{y})$ is the polar angle in real space. The fact that n is an integer guarantees that after a full rotation in real space the field $\psi \propto e^{i\phi}$ is single valued.

The current is given by:

$$J = \rho_s \nabla \phi = \rho_s \frac{n}{r} \hat{\theta}.$$

It is easy to show, using Stoke's theorem, that $\vec{\nabla} \times \vec{\nabla} \phi = 2\pi n \delta(r)$.

This seems to diverge for small r but we have a cutoff $r > \xi$. The velocity is:

$$v = \frac{\hbar}{m} \frac{n}{r} \hat{\theta}.$$

The proportionality of the velocity field to $1/r$ is very different from a rigid rotation where

$$v = \omega r \hat{\theta}, \nabla \times v = \omega \hat{z}$$

8 Superconductivity

8.1 Basic Model and Mean field solution

Tutorial number 4.

8.2 The Anderson -Higgs Mechanism

8.2.1 Local gauge symmetry

The essential difference from the case of the superfluid is that the particles are charged so we must add coupling to the electromagnetic field. We now consider the consequences of coupling a Goldstone mode to a gauge field. As we will see, this will give rise to the various known experimental consequences of superconductors. In the tutorial we will get this effective field theory from the microscopic BCS theory.

The coupling to the electromagnetic field is done by the “minimal coupling”

$$S = \int \frac{1}{2m} \left| \left(\nabla - \frac{ie}{\hbar} A \right) \psi \right|^2.$$

This changes the symmetry from a global $U(1)$ to a local gauge invariance under $U(1)$

$$\psi \rightarrow \psi e^{i\phi(x)}, \quad A \rightarrow A - \nabla\phi(x)$$

and in the polar representation, taking $e = \hbar = c = 1$, (and completely ignoring the fluctuations in $\sqrt{\rho}$), we get

$$= \int \frac{\rho_0}{2m} (\nabla\phi - A)^2.$$

On the other hand, taking the lowest orders in the density fluctuations, and following steps similar to the ones we performed for the neutral superfluid, we get after integrating out the massive fluctuations of the amplitude ρ (restoring the universal factors e, c, \hbar)

$$S = \frac{1}{2} \int d\tau \int d^3r \frac{(\partial_\tau \phi)^2}{u} + \frac{\rho_0}{m} \left(\nabla\phi - \frac{e}{c\hbar} A \right)^2.$$

When Quantum fluctuations can be ignored?

To study the Anderson Mechanism we will ignore quantum fluctuations – when is that justified? The full GL action is

$$S[\phi, A] = \frac{1}{2} \int d\tau d^3r \frac{1}{u} (\partial_\tau \phi - eA_0)^2 + (\nabla A_0)^2 + \frac{\rho_0}{m} (\nabla \phi - A) + (\nabla \times A)^2$$

Looking at the terms which contain A_0 in fourier space, we have

$$\frac{1}{u} \omega^2 \phi^2 + \underbrace{\frac{2}{u} e \omega \phi A_0}_a + \underbrace{\left(\frac{e^2}{u} + q^2 \right)}_b A_0^2$$

integrating over A_0 gives

$$\left[\frac{1}{u} \omega^2 - \underbrace{\frac{\left(\frac{1}{u} e \omega \right)^2}{\left(\frac{e^2}{u} + q^2 \right)}}_{a^2/4b} \right] \phi^2 = \frac{\omega^2 q^2}{\frac{e^2}{u} + q^2}$$

Assuming no magnetic field and minimizing the free energy of the full action we have

$$\frac{\omega^2 q^2}{\frac{e^2}{u} + q^2} = \frac{\rho_0}{m} q^2$$

which for small q gives

$$\omega^2 = \frac{\rho_0}{m} \frac{e^2}{u} = \frac{4\pi e^3 n}{m} = \omega_p^2$$

This is the plasma frequency. It is related to the dielectric constant of a material by the following development (see p. 18 of Ref. [2])

$$\frac{d\rho}{dt} = eE, \frac{dj}{dt} = -\frac{e^2 n E}{m}; \quad i\omega j = -\frac{en}{m} E \equiv \sigma(\omega) E \text{ with } \sigma(\omega) = \frac{ie^2 n}{m\omega}$$

using Maxwell's equations we find:

$$-\nabla^2 E = \nabla \times \nabla \times E = i \frac{\omega}{c} \nabla \times H = i \frac{\omega}{c} \left(\frac{4\pi}{c} j - \frac{i\omega}{c} E \right) = \frac{\omega^2}{c^2} \left(1 + \frac{4\pi i \sigma}{\omega} \right) E \equiv \frac{\omega^2}{c^2} \varepsilon(\omega) E \quad (61)$$

and by definition

$$\varepsilon(\omega) = \left(1 - \frac{\omega_p^2}{\omega^2} \right)$$

When ε is real and negative $\omega < \omega_p$ the solution of Eq. (61) decay in space, i.e. electric field can not propagate in the material, for $\omega > \omega_p$ radiation can propagate in the metal and it become transparent.

The q^2 term came from a 3D Fourier transform of a Coulomb interaction $V(q)$. When the material is confined 2D (and the electric field lines can propagate in 3D) $v(q) \propto q$, giving $\omega \sim \sqrt{q}$. In 1D metal of width a when $V(q) \propto \log qa$ given $\omega \sim q$ and quantum fluctuations can not be ignored.

Taking the classical approximation (no τ dependence) and adding a Maxwell term for the action of the magnetic field

$$S[A, \phi] = \frac{\beta}{2} \int d^3r \frac{\rho_0}{m} \left(\nabla \phi - \frac{e}{c\hbar} A \right)^2 + (\nabla \times A)^2 = \frac{\beta}{2} \int d^3r \frac{\rho_0}{m} \left(\nabla \phi - \frac{e}{c\hbar} A \right)^2 + \frac{\beta}{2} \int d^3r |B|^2.$$

In momentum space

$$S[A, \phi] = \frac{\beta}{2} \sum_q \frac{\rho_0}{m} \left(i\vec{q}\phi_{\vec{q}} - \vec{A}_{\vec{q}} \right) \left(-i\vec{q}\phi_{-\vec{q}} - \vec{A}_{-\vec{q}} \right) + \left(\vec{q} \times \vec{A}_{\vec{q}} \right) \left(-\vec{q} \times \vec{A}_{-\vec{q}} \right)$$

$$= \frac{\beta}{2} \sum_q \frac{\rho_0}{m} \left[q^2 \phi_{\vec{q}} \phi_{-\vec{q}} - 2i\vec{q} \cdot \vec{A}_{-\vec{q}} \phi_{\vec{q}} + \vec{A}_{\vec{q}} \cdot \vec{A}_{-\vec{q}} \right] + (\vec{q} \times \vec{A}_{\vec{q}}) (-\vec{q} \times \vec{A}_{-\vec{q}})$$

We break up \vec{A} into a longitudinal and transverse part: $\vec{A}_{\vec{q}} = \underbrace{\vec{A}_{\vec{q}} - \frac{\vec{q}(\vec{q} \cdot \vec{A}_{\vec{q}})}{q^2}}_{A_{\perp}} + \underbrace{\frac{\vec{q}(\vec{q} \cdot \vec{A}_{\vec{q}})}{q^2}}_{A_{\parallel}}$.

Notice that only the transverse part will contribute to the magnetic field, since $\vec{B}_{\vec{q}} = \vec{q} \times A_{\vec{q}}^{\perp}$ (since $\vec{q} \times \vec{q} = 0$). Performing a gaussian integral on the ϕ degrees of freedom ($\int e^{-x^2+yx} \sim e^{y^2}$) we have

$$\begin{aligned} S[A] &= \frac{\beta}{2} \sum_q \frac{\rho_0}{m} \left[\vec{A}_{\vec{q}} \cdot \vec{A}_{-\vec{q}} - \frac{(\vec{q} \cdot \vec{A}) (\vec{q} \cdot \vec{A})}{q^2} \right] + (\vec{q} \times \vec{A}_{\vec{q}}) (-\vec{q} \times \vec{A}_{-\vec{q}}). \\ &= \frac{\beta}{2} \sum_q \left(\frac{\rho_0}{m} + q^2 \right) A_{\vec{q}}^{\perp} A_{-\vec{q}}^{\perp}. \end{aligned}$$

The equation of motion is

$$\left(\frac{\rho_0}{m} - \nabla^2 \right) A_{\perp} = 0. \quad (62)$$

The mechanism that we encounter here can be summarized as follows:

1. A symmetry breaking that we find through a mean field solution.
2. The appearance of Goldstone soft modes ϕ in the superconducting case.
3. Coupling between the Goldstone mode and the gauge field A .
4. Upon integrating the Goldstone mode, the gauge field acquires a mass.

This is known as the Anderson Higgs mechanism.

8.3 London Equations (Phenomenology of Superconductivity)

Taking a curl of Eq.(62) we get

$$\left(\frac{\rho_0}{m} - \nabla^2 \right) B = 0. \quad (63)$$

This is the first London equation. It shows that the field decays inside the superconductor with a length scale

$$\lambda = \sqrt{\frac{m}{\rho_0}} = \sqrt{\frac{mc^2}{4\pi n_s e^2}},$$

where n_s represents the density of particles in the superconducting phase.

Since

$$\nabla \times \nabla \times A = \frac{4\pi}{c} j$$

if we choose the London gauge

$$\vec{q} \cdot \vec{A}_{\vec{q}} = 0$$

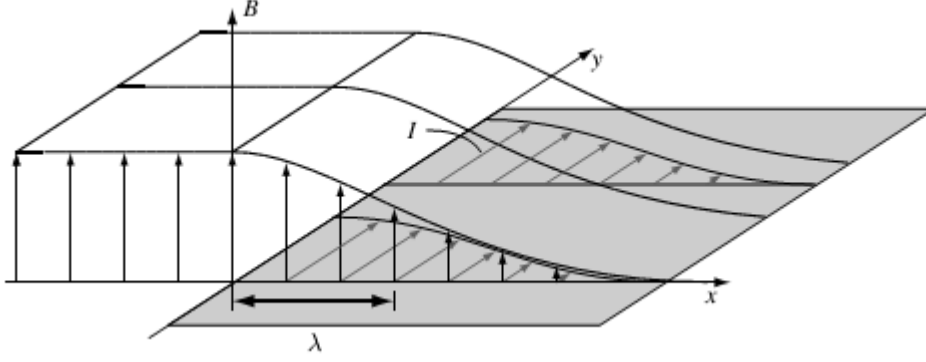

Figure 10: The Meissner effect: due to the Anderson-Higgs mechanism. An external field outside the superconductor induced diamagnetic supercurrent inside the superconductor – these current generates a counter field that diminishes the external field.

we get

$$q \times q \times A_{\perp} = q^2 A_{\perp}$$

$$\nabla^2 A = \frac{4\pi}{c} j$$

$$j = \frac{mc}{n_s e^2} A. \quad (64)$$

Eq. (64) is known as the second London equation. It presents a perfect diamagnetism (notice that it is not gauge invariant).

Physically the Meissenner effect results from currents that, due the the Biot-Savart law, create magnetic fields that cancel the external one, see figure .

8.4 Vortices in Superconductor

8.4.1 The magnetic field penetration depth

To study the behavior of magnetic field in superconducting region we will start from the Ginzburg-Landau theory. The Ginzburg Landau theory can be obtained by introducing a Habburd-Stratanovich field Δ that decouples the interaction term $g\psi^4 \rightarrow \bar{\Delta}\psi_{\downarrow}\psi_{\uparrow} + \Delta\bar{\psi}_{\uparrow}\bar{\psi}_{\downarrow} - \frac{|\Delta|^2}{g}$ the action is then quadratic in ψ so we can integrate out the ψ field and expand the action, assuming that Δ is small. We finally get (See [7] for details):

$$\mathcal{F}_s = \int f_s d^3x$$

$$f_s = f_n + \alpha |\Psi|^2 + \frac{\beta}{2} |\Psi|^4 + \frac{1}{2m} \left| \left(\frac{\hbar}{i} \nabla - \frac{e^*}{c} A \right) \Psi \right|^2 + \frac{B^2}{8\pi}$$

were we switch to the notation $\Delta \rightarrow \Psi$. A microscopic theory gives

$$\alpha = \alpha' \frac{T - T_c}{T_c}, \quad \alpha' = \frac{12\pi^2 m T_c^2}{\zeta(3) P_F^2}, \quad \beta = \frac{\alpha'}{n_e}, \quad e^* = 2e, \quad m^* = 2m$$

where n_e is the electron density. f_n describes the free energy of electrons which aren't in the superconducting phase. B is the magnetic field. For $\alpha < 0$ we have a minimum at

$$f_s - f_n = \frac{-\alpha^2}{2\beta} + \frac{B^2}{8\pi}$$

We expect that the field will eventually be too strong to be repelled by the superconductor, and the critical magnetic field is found from the above equation

$$\frac{H_c^2}{8\pi} = \frac{\alpha^2}{2\beta} = \frac{n_e m T_c^2}{P_F^2} = m P_F T_c^2$$

$m P_F$ is the density of states at E_F .

This result should not be surprising as in the normal state we have electrons near the Fermi level, while in the superconducting state a gap of size Δ is formed the energy of the electrons that are "repelled" from the Fermi surface is $\sum_{i, \epsilon_i < \Delta} \epsilon_i \sim \nu \Delta^2$. (See exercise)

We can identify a magnetic length by comparing terms in \mathcal{F}

$$\frac{B^2}{8\pi} = \frac{(\nabla \times A)^2}{8\pi} \propto \frac{1}{\lambda^2} \frac{A^2}{8\pi} \sim \frac{e^{*2}}{c^2} \frac{1}{2m^*} |\psi^2| A^2$$

$$\lambda_{\text{eff}}^2 = \frac{m^* c^2}{4\pi |\psi|^2 e^{*2}}$$

$$|\Psi_\infty|^2 = -\frac{\alpha}{\beta} = n_s^* = \frac{n_e}{2} = \frac{m^* c^2}{4\pi e^{*2}} = \frac{m^* c^2}{8\pi e^2 \lambda_{\text{eff}}^2}.$$

Notice that the units in the last equation are right as \hbar/mc has units of length and $\hbar c/e^2$ is dimensionless so that $|\Psi_\infty|^2$ has units of 1/volume as it should. Finally we can identify

$$\alpha(T) = \frac{2e^2}{mc^2} H_c^2(T) \lambda_{\text{eff}}^2(T).$$

These relations are useful as H_c and λ are experimentally measurable quantities, so we can find α even without a microscopic theory.

05/07/13

8.4.2 The Coherence Length

We discussed the following free energy for the superconductor

$$f_s = f_n + \alpha |\Psi|^2 + \frac{\beta}{2} |\Psi|^4 + \frac{1}{2m^*} \left| \left(\frac{\hbar}{i} \nabla - \frac{e^*}{c} A \right) \Psi \right|^2 + \frac{B^2}{8\pi}$$

and found the magnetic length

$$\lambda_{\text{eff}}^2 = \frac{m^* c^2}{4\pi |\psi|^2 e^{*2}}$$

We can also define another length scale - the coherence length. Minimizing the free energy, we get the equation

$$\frac{\delta f}{\delta \psi^*} = 0 \Rightarrow \alpha \psi + \beta \psi^* \psi^2 - \frac{1}{2m^*} \psi'' = 0.$$

which has the homogeneous solution

$$|\psi_\infty|^2 = -\frac{\alpha}{\beta}.$$

Dividing the equation by ψ_∞ , we get

$$\frac{\psi}{\psi_\infty} - \left(-\frac{\beta}{\alpha}\right) \frac{\psi^*}{\psi_\infty} \psi^2 - \frac{1}{2m^* \alpha} \frac{\psi''}{\psi_\infty} = 0.$$

Assuming ψ is real and defining $f = \frac{\psi}{\psi_\infty}$ we have

$$f - f^3 + \frac{\hbar^2}{2m^* |\alpha|} f'' = 0.$$

The coefficient of the last term has units of 1/area, which allows us to define a coherence length:

$$\xi^2(T) = \frac{\hbar^2}{2m^* |\alpha|} \propto \frac{T_c}{T_c - T}.$$

At zero temperature

$$\xi^2(T=0) \propto \frac{1}{m\alpha} \underbrace{\qquad}_{\text{microscopic expression for } \alpha} \propto \frac{p_f^2}{m^2 T_c^2} = \frac{v_f^2}{T_c^2} \Rightarrow \xi = \frac{v_f}{T_c}$$

For dirty systems with diffusion we derive a length scale from the diffusion equation which contains the mean free path due to diffusion:

$$\frac{D}{\xi_d^2} = T_c \Rightarrow \xi_d = \sqrt{\frac{D}{T_c}} = \sqrt{\frac{v_p l}{T_c}} = \sqrt{\xi l}$$

We can look at small deviations from ψ_∞ by defining $f = g + 1$ and linearizing the equation

$$(1 + g) - (1 + g)^3 + \xi^2 g'' = 0$$

$$\xi^2 g'' = 2g$$

$$g \sim e^{\pm\sqrt{2}x/\xi}.$$

8.4.3 Two types of superconductors

The relation between the two length scales defines two types of superconductors.

In type I materials, $\lambda \ll \xi$ we expel the magnetic field which costs energy, but are not yet in the superconducting phase which is beneficial energetically, hence such a boundary costs energy

$$F_b > 0$$

In type II materials, $\lambda \gg \xi$

In this case we obtain the reduced energy of entering the superconducting phase without having to spend much energy on expelling the field. We then have

$$F_b < 0$$

and it becomes energetically favorable to increase the boundary as much as possible, which is done by generating vortices. The phase diagram for type II looks like this (see Fig 12)

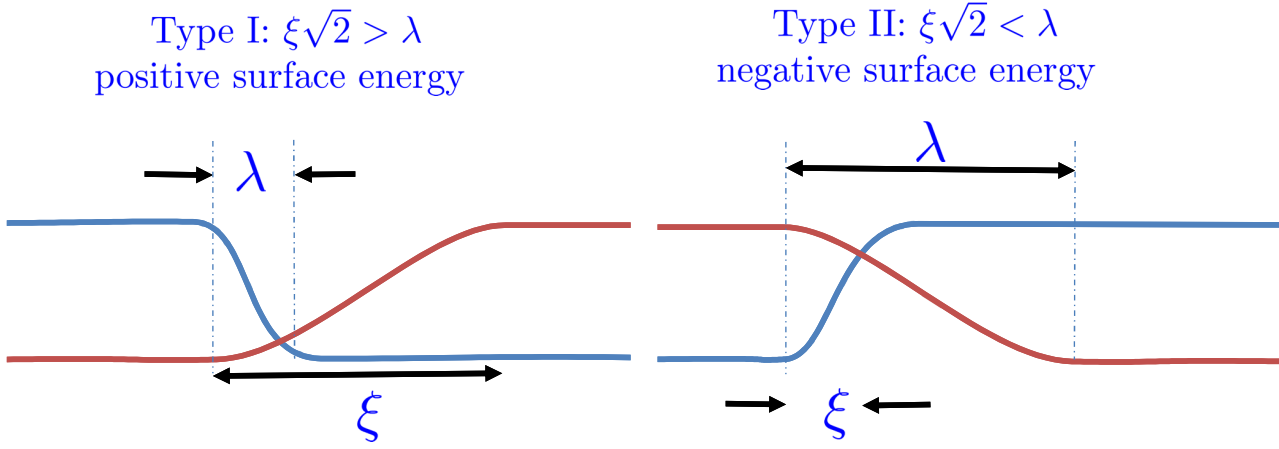

Figure 11: The surface energy is positive when $\lambda < \xi$ we "pay" (the free energy is positive) for repelling magnetic field and still do not gain energy from the superconductor. For $\lambda > \xi$ we have superconductor and still do not repel the magnetic field hence "gain" from both, the surface energy is negative.

We recall that each vortex carries at least Φ_0 of flux. Hence if the flux through the entire model is less than Φ_0 there can be no vortices and we have a perfect Meissner effect. The next phase allows creation of vortices. Eventually the vortices are so common that they coalesce, leaving the superconducting phase only on the boundary.

8.4.4 Vortices in Type II superconductor

Looking at a type II superconductor near H_{c1} where we have a single vortex. The energy is

$$F = \int d^3r \frac{1}{8\pi} [h^2 + \lambda^2 (\nabla \times h)^2]$$

the last term is the kinetic energy which was derived using $j = en_s v = \nabla \times h \frac{4\pi}{c}$ and $\lambda = \sqrt{\frac{mc^2}{4\pi n_s}}$

$$E_{kin} = \frac{1}{2} m v^2 n_s = \frac{1}{2} \frac{m}{n_s e^2} j^2 = \lambda^2 (\nabla \times h)^2$$

Taking a variation we derive the equation of motion:

$$h + \lambda^2 \nabla \times \nabla \times h = 0$$

We want to solve for a single vortex hence we add a term to ensure the integration over the surface gives the correct flux.

$$h + \lambda^2 \nabla \times \nabla \times h = \Phi_0 \delta(r)$$

integrating over the surface of the model

$$\int dsh + \lambda^2 \int ds \nabla \times \nabla \times h = \int dsh + \lambda^2 \oint_c dl \nabla \times h = \Phi_0$$

For $r \gg \lambda$, the field is effectively uniform along the integration contour and the second term drops giving

$$\int dsh = \Phi_0$$

while if $\xi < r < \lambda$ the first term is negligible

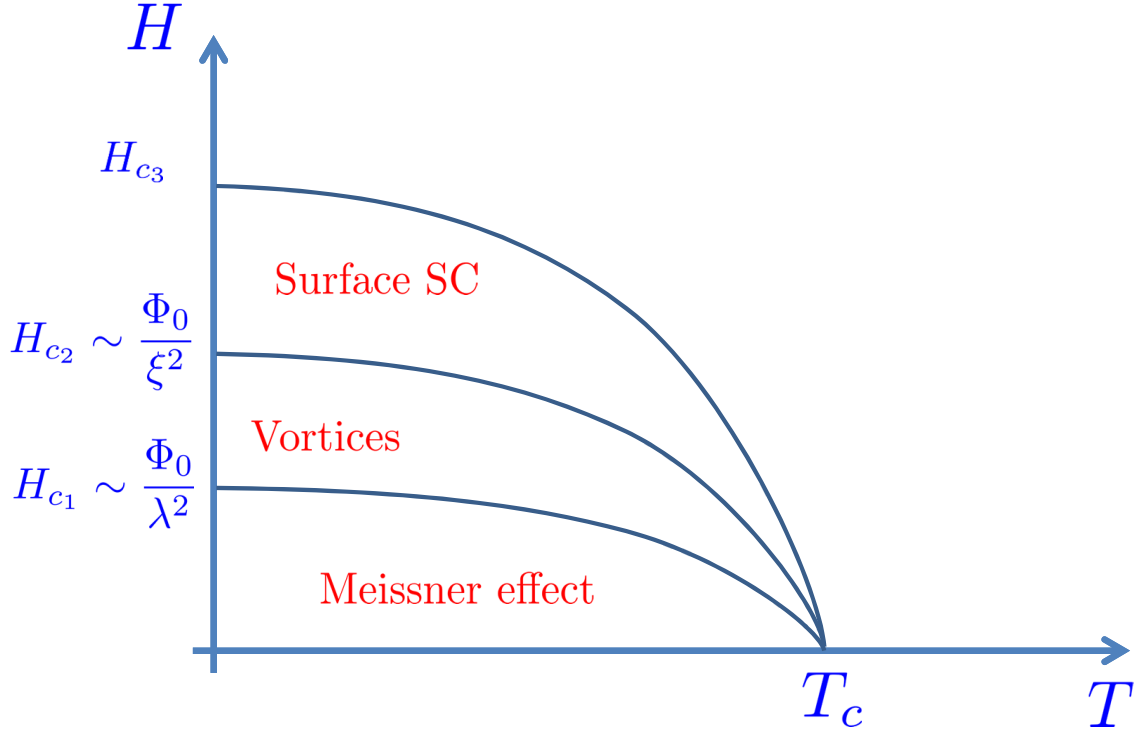

Figure 12: H_{c1} the critical field when the first vortex penetrates. H_{c2} when the vortices core overlap and H_{c3} when the residue superconductivity on the surface disappears

$$\lambda^2 \oint_c d\ell \nabla \times h = 2\pi r \lambda^2 \nabla \times h = \Phi_0$$

$$\frac{dh}{dr} = \frac{\Phi_0}{2\pi\lambda^2} \frac{1}{r}$$

$$h = \frac{\Phi_0}{2\pi\lambda^2} \left(\log\left(\frac{\lambda}{r}\right) + const \right)$$

while for $r \gg \lambda$ we have $h \sim e^{-r/\lambda}$.

We can also solve exactly by a Fourier transform:

$$h + \lambda^2 h'' = \Phi_0 \delta(r)$$

$$(1 + \lambda^2 k^2) h_k = \Phi_0$$

$$h(r) = \frac{\Phi_0}{(2\pi)^2} \int \frac{e^{ikr\cos\theta} k dk d\theta}{1 + \lambda^2 k^2} = \frac{\Phi_0}{2\pi} \int \frac{k dk}{1 + \lambda^2 k^2} J_0(kr) = \frac{\Phi_0}{2\pi\lambda^2} K_0(r/\lambda)$$

The free energy of a vortex of a model of height L is given by

$$F_{vor} = \int dV \frac{h^2 + \lambda^2 (\nabla \times h)^2}{8\pi} = \frac{\Phi_0}{8\pi} \frac{\Phi_0}{2\pi\lambda^2} \log\left(\frac{\lambda}{\xi}\right) L$$

The critical field for creating separated N vortex is thus given by

$$0 = F_{vor} - \int \frac{BH_{c1}}{4\pi} = N \left(F_{vor} - \frac{\Phi_0 H_{c1}}{4\pi} \right)$$

where the second term is the multiplication of the internal B field by the external one (see Ref. [4] (pages 33 50 and 66)).

$$H_{c1} = \frac{\Phi_0}{4\pi\lambda^2} \log \left(\frac{\lambda}{\xi} \right)$$

We ignored the energetic cost of destroying the superconducting phase in this calculation. The energy we gained per unit volume of superconductor is

$$\frac{\alpha^2}{\beta} = \frac{H_c^2}{8\pi} \propto mp_F T_c^2$$

(H_c is defined for type 1 superconductors)

and this the energy loss due to the creation of the core of the vortex is

$$E_{core} = C\nu T_c^2 \xi^2 L$$

where ν is the density of states, and C is some parameter which contains the details of the shape of the core.

9 The BCS theory of superconductivity (Tutorial)

In the lectures you saw a phenomenological analysis of superconductors. In particular, you saw that given some empirical results, many additional predictions can be made using the Ginzburg-Landau formalism. Historically, this approach has been very successful. However, the theory is still incomplete without a microscopic explanation. In this tutorial we will fill this gap by reviewing the famous BCS theory, established by Bardeen, Cooper, and Schrieffer about 50 years after the initial discovery of superconductivity. Then, we will connect the microscopic picture to the phenomenological one by deriving the Ginzburg-Landau theory.

9.1 Preliminaries

The BCS theory is based on two important insights:

1. Cooper's realization that attractive interactions between electrons in the vicinity of the Fermi-energy favor the formation of bound states made of two electrons, called cooper pairs.
2. The result that interaction between two electrons, mediated by phonons, can be attractive.

Once one realizes these things, the next step is to assume that the ground state of a many body system with attractive interactions can be described in terms of a condensate of such weakly interacting pairs. The pairs satisfy Bose statistics, giving rise to a physics similar to that of a superfluid, yet different due to the fact that the bosons are now charged. We will see that this picture is capable of explaining superconductivity. We begin by elaborating on the above two crucial points:

9.1.1 Attractive interaction for fermions

We begin by analyzing the possibility of having attractive interactions between electrons. As it turns out, such electron-electron interaction can originate from electron-phonon coupling, namely mediated by phonons. We will only discuss a very qualitative picture here, but this can be made more rigorous. The idea is that an electron can pass at some time near an ion and distort it from its equilibrium position by attraction. Since the ions are much slower than the electrons $\omega_D^{-1} \gg E_F^{-1}$ the ion will not relax to equilibrium long after the electron passed through. The result is that for a long time (in the electronic scale), at the distorted position, on the path of the original electron, there is a concentration of positive charge attracting other electrons. The net effect is an attractive interaction between the two electrons (which in reality is mediated by the phonons) that overcomes the Coulomb repulsion.

9.1.2 Formation of bound states: Cooper pairs

To see that pairs of electrons can form bound states, we examine the following toy model. We imagine two electrons, with an attractive interaction between them, on top of a Fermi sea. The two additional electrons do not interact with the Fermi sea electrons, but feel their presence via the Pauli exclusion principle. We would like to find the corresponding two-electron eigenstates.

We assume that the total momentum is zero and that the spin-part of the wavefunction is antisymmetric, such that

$$\psi(\mathbf{r}_1, \mathbf{r}_2) \propto \sum_{\mathbf{k}} \left[g_{\mathbf{k}} e^{i\mathbf{k} \cdot (\mathbf{r}_1 - \mathbf{r}_2)} \right] \left(\frac{|\uparrow_1 \downarrow_2\rangle - |\downarrow_1 \uparrow_2\rangle}{\sqrt{2}} \right). \quad (65)$$

The Schrodinger equation for the two electrons is

$$[H_0(\mathbf{r}_1) + H_0(\mathbf{r}_2) + V(\mathbf{r}_1 - \mathbf{r}_2)] \psi(\mathbf{r}_1, \mathbf{r}_2) = E \psi(\mathbf{r}_1, \mathbf{r}_2), \quad (66)$$

and plugging in our anzats, Eq.(65), we find

$$\sum_{\mathbf{k}} g_{\mathbf{k}} [H_0(\mathbf{r}_1) + H_0(\mathbf{r}_2) + V(\mathbf{r}_1 - \mathbf{r}_2)] e^{i\mathbf{k} \cdot (\mathbf{r}_1 - \mathbf{r}_2)} = E \sum_{\mathbf{k}} g_{\mathbf{k}} e^{i\mathbf{k} \cdot (\mathbf{r}_1 - \mathbf{r}_2)}. \quad (67)$$

For a translation-invariant system H_0 is diagonal in \mathbf{k} -space so we can write $H_0(r_i)e^{i\mathbf{k}\cdot(\mathbf{r}_1-\mathbf{r}_2)} = \epsilon_{\mathbf{k}}e^{i\mathbf{k}\cdot(\mathbf{r}_1-\mathbf{r}_2)}$ leading to

$$\sum_{\mathbf{k}} g_{\mathbf{k}} [2\epsilon_{\mathbf{k}} + V(\mathbf{r}_1 - \mathbf{r}_2)] e^{i\mathbf{k}\cdot(\mathbf{r}_1-\mathbf{r}_2)} = E \sum_{\mathbf{k}} g_{\mathbf{k}} e^{i\mathbf{k}\cdot(\mathbf{r}_1-\mathbf{r}_2)} , \quad (68)$$

which we can now multiply by $e^{-i\mathbf{q}\cdot(\mathbf{r}_1-\mathbf{r}_2)}$ and integrate, over r_1 for example, to get

$$2g_{\mathbf{q}}\epsilon_{\mathbf{q}}\Omega + \sum_{\mathbf{k}} g_{\mathbf{k}} \int d\mathbf{r}_1 V(\mathbf{r}_1 - \mathbf{r}_2) e^{i(\mathbf{k}-\mathbf{q})(\mathbf{r}_1-\mathbf{r}_2)} = E g_{\mathbf{q}}\Omega , \quad (69)$$

Changing integration variables to $\mathbf{r} = \mathbf{r}_1 - \mathbf{r}_2$ and defining

$$V_{\mathbf{k},\mathbf{q}} = \frac{1}{\Omega} \int d\mathbf{r} V(\mathbf{r}) e^{i(\mathbf{k}-\mathbf{q})\mathbf{r}} , \quad (70)$$

we find the following equation:

$$\sum_{\mathbf{k}} g_{\mathbf{k}} V_{\mathbf{k},\mathbf{q}} = g_{\mathbf{q}} (E - 2\epsilon_{\mathbf{q}}) \quad (71)$$

Obviously the energies depend on the form of the interaction $V_{\mathbf{k},\mathbf{q}}$, but since the phenomena we want to see should be universal for Fermions with attractive interactions, we can pick a simple form such as

$$V_{\mathbf{k},\mathbf{q}} = \begin{cases} -V & E_F < \epsilon_{\mathbf{k}}, \epsilon_{\mathbf{q}} < E_F + \Delta E \\ 0 & \text{Otherwise} \end{cases} . \quad (72)$$

This merely means that the attractive interactions only affect electrons occupying states in a small energy shell ΔE above the Fermi-sea. Plugging this form of the interactions into Eq.(71) we find

$$-V \sum_{\mathbf{k}} g_{\mathbf{k}} = (E - 2\epsilon_{\mathbf{q}}) g_{\mathbf{q}} , \quad (73)$$

where the sum over \mathbf{k} is restricted to \mathbf{k} values satisfying the requirement in Eq.(72), namely for which $\epsilon_{\mathbf{k}}$ is within ΔE from the Fermi surface. Dividing the equation by $E - 2\epsilon_{\mathbf{q}}$ and summing over \mathbf{q} (under the same restrictions), we get

$$-\sum_{\mathbf{q}} \frac{V}{E - 2\epsilon_{\mathbf{q}}} = 1 . \quad (74)$$

We now transform the sum over \vec{k} to an integral over energy, introducing the density of states $n(\epsilon)$ to find

$$-\int_{E_F}^{E_F+\Delta E} d\epsilon \frac{V n(\epsilon)}{E - 2\epsilon} = 1 . \quad (75)$$

Since we integrate over a thin shell ΔE we can assume the DOS does not change over it and approximate it by $\nu(E_F)$. Then it can be taken out of the integral which is now easily solved to give

$$\frac{V n(E_F)}{2} \log \left(\frac{E - 2(E_F + \Delta E)}{E - 2E_F} \right) = 1 , \quad (76)$$

$$\Rightarrow E = 2E_F - 2\Delta E e^{-\frac{2}{V n(E_F)}} . \quad (77)$$

Remember that until now we considered adding two electron on top of the Fermi-sea. Let's now think instead of taking two electron from the Fermi-surface and putting them into this cooper pair bound state. Obviously removing the from the Fermi-surface saves $2E_F$ of energy. Therefore, it is clear that taking pairs of electron from the Fermi-sea and putting them into cooper pairs saves energy in the amount of $2\Delta E e^{-\frac{2}{V n(E_F)}} > 0$, and is thus energetically favorable. This result demonstrates a general principle: if there is an attractive interaction (which can be arbitrarily small) between the electrons, there is an instability towards the formation of cooper pairs. Therefore one can then assume that the ground state of a many-body system with attractive interactions is composed of many weakly interacting pairs.

9.2 BCS theory of superconductivity

Having the above physics in mind, we postulate that as the system becomes superconducting, there is an instability toward condensation of pairs. To investigate the physics that arises from that, we assume that the ground state of a system with attractive interactions $|\Omega_s\rangle$ is characterized by a macroscopic number of pairs. This means that $\Delta = \frac{g}{\Omega} \sum_{\mathbf{k}} \langle \Omega_s | \psi_{-\mathbf{k},\downarrow} \psi_{\mathbf{k}\uparrow} | \Omega_s \rangle$, and its complex conjugate $\bar{\Delta} = \frac{g}{\Omega} \sum_{\mathbf{k}} \langle \Omega_s | c_{\mathbf{k}\uparrow}^\dagger c_{-\mathbf{k},\downarrow}^\dagger | \Omega_s \rangle$ are non-zero. We regard these quantities as the order parameters of our system.

With the above assumption, we use the usual mean field formulation to transform the interacting Hamiltonian into a quadratic one, neglecting some quantum fluctuations. We start from a system of fermions with attractive contact interactions

$$H = \sum_{\mathbf{k},\sigma} n_{\mathbf{k},\sigma} (\epsilon_{\mathbf{k}} - \mu) - \frac{g}{\Omega} \sum_{\mathbf{k},\mathbf{k}',\mathbf{q}} \psi_{\mathbf{k}+\mathbf{q}\uparrow}^\dagger \psi_{-\mathbf{k}\downarrow}^\dagger \psi_{-\mathbf{k}'+\mathbf{q}\downarrow} \psi_{\mathbf{k}'\uparrow}. \quad (78)$$

Under our mean-field assumption, $\sum_{\mathbf{k}'} \psi_{-\mathbf{k}'+\mathbf{q}\downarrow} \psi_{\mathbf{k}'\uparrow}$, is governed by small \mathbf{q} 's (only very long wavelength fluctuations), and has a mean-field value about which fluctuations are small. Therefore, we write

$$\begin{aligned} \sum_{\mathbf{k}'} \psi_{-\mathbf{k}'+\mathbf{q}\downarrow} \psi_{\mathbf{k}'\uparrow} &\approx \sum_{\mathbf{k}'} \psi_{-\mathbf{k}'\downarrow} \psi_{\mathbf{k}'\uparrow} = \frac{\Omega\Delta}{g} + \underbrace{\sum_{\mathbf{k}'} \psi_{-\mathbf{k}'\downarrow} \psi_{\mathbf{k}'\uparrow} - \frac{\Omega\Delta}{g}}_{\text{Small}}, \\ \sum_{\mathbf{k}} \psi_{\mathbf{k}+\mathbf{q}\uparrow}^\dagger \psi_{-\mathbf{k}\downarrow}^\dagger &\approx \sum_{\mathbf{k}} \psi_{\mathbf{k}\uparrow}^\dagger \psi_{-\mathbf{k}\downarrow}^\dagger = \frac{\Omega\bar{\Delta}}{g} + \underbrace{\sum_{\mathbf{k}} \psi_{\mathbf{k}\uparrow}^\dagger \psi_{-\mathbf{k}\downarrow}^\dagger - \frac{\Omega\bar{\Delta}}{g}}_{\text{Small}}. \end{aligned} \quad (79)$$

Plugging these into the Hamiltonian and keeping only the first order terms in the small fluctuations, we get the mean-field Hamiltonian

$$H_{\text{MF}} = \sum_{\mathbf{k},\sigma} n_{\mathbf{k},\sigma} (\epsilon_{\mathbf{k}} - \mu) + \frac{\Omega}{g} |\Delta|^2 - \Delta \sum_{\mathbf{k}} \psi_{\mathbf{k}\uparrow}^\dagger \psi_{-\mathbf{k}\downarrow}^\dagger - \bar{\Delta} \sum_{\mathbf{k}} \psi_{-\mathbf{k}\downarrow} \psi_{\mathbf{k}\uparrow}, \quad (80)$$

which is sometimes called the Bogoliubov de-Gennes (BdG) Hamiltonian.

We have transformed the interacting Hamiltonian into a quadratic mean-field Hamiltonian that captures the correct ordering in our system. Note, however, that this form is dramatically different than the type of mean-field Hamiltonians we usually write as it doesn't conserve the number of particles. The number of particles is indeed not conserved, but the parity of that number (i.e., the number of particles mod 2) remains a good quantum number. We would now like to diagonalize the BDG Hamiltonian. To do so, we define the Nambu-spinor $\Psi_{\mathbf{k}} = \begin{pmatrix} \psi_{\mathbf{k}\uparrow} & \psi_{-\mathbf{k}\downarrow}^\dagger \end{pmatrix}^T$, in terms of which the Hamiltonian is given by

$$\begin{aligned} H &= \frac{\Omega}{g} |\Delta|^2 + \sum_{\mathbf{k}} (\epsilon_{\mathbf{k}} - \mu) + \sum_{\mathbf{k}} \Psi_{\mathbf{k}}^\dagger h_{\text{BDG}} \Psi_{\mathbf{k}}, \\ h_{\text{BDG}} &= \begin{pmatrix} \epsilon_{\mathbf{k}} - \mu & -\Delta \\ -\bar{\Delta} & -(\epsilon_{\mathbf{k}} - \mu) \end{pmatrix}. \end{aligned} \quad (81)$$

To explicitly see that this is correct we plug in the definition of $\Psi_{\mathbf{k}}$:

$$\begin{aligned} H &= \frac{\Omega}{g} |\Delta|^2 + \sum_{\mathbf{k}} (\epsilon_{\mathbf{k}} - \mu) + \sum_{\mathbf{k}} \Psi_{\mathbf{k}}^\dagger h_{\text{BDG}} \Psi_{\mathbf{k}} \\ &= \frac{\Omega}{g} |\Delta|^2 + \sum_{\mathbf{k}} (\epsilon_{\mathbf{k}} - \mu) + \sum_{\mathbf{k}} \left[(\epsilon_{\mathbf{k}} - \mu) (\psi_{\mathbf{k}\uparrow}^\dagger \psi_{\mathbf{k}\uparrow} - \psi_{-\mathbf{k}\downarrow}^\dagger \psi_{-\mathbf{k}\downarrow}^\dagger) - (\Delta \psi_{\mathbf{k}\uparrow}^\dagger \psi_{-\mathbf{k}\downarrow}^\dagger + \bar{\Delta} \psi_{-\mathbf{k}\downarrow} \psi_{\mathbf{k}\uparrow}) \right] \\ &= \sum_{\mathbf{k},\sigma} n_{\mathbf{k},\sigma} (\epsilon_{\mathbf{k}} - \mu) + \frac{\Omega}{g} |\Delta|^2 - \Delta \sum_{\mathbf{k}} \psi_{\mathbf{k}\uparrow}^\dagger \psi_{-\mathbf{k}\downarrow}^\dagger - \bar{\Delta} \sum_{\mathbf{k}} \psi_{-\mathbf{k}\downarrow} \psi_{\mathbf{k}\uparrow}. \end{aligned} \quad (82)$$

Now, the matrix h_{BDG} , being hermitian, can always be diagonalized by a unitary transformation such that (assuming Δ is real)

$$U h_{\text{BDG}} U^{-1} = \begin{pmatrix} \lambda_{\mathbf{k}} & 0 \\ 0 & -\lambda_{\mathbf{k}} \end{pmatrix},$$

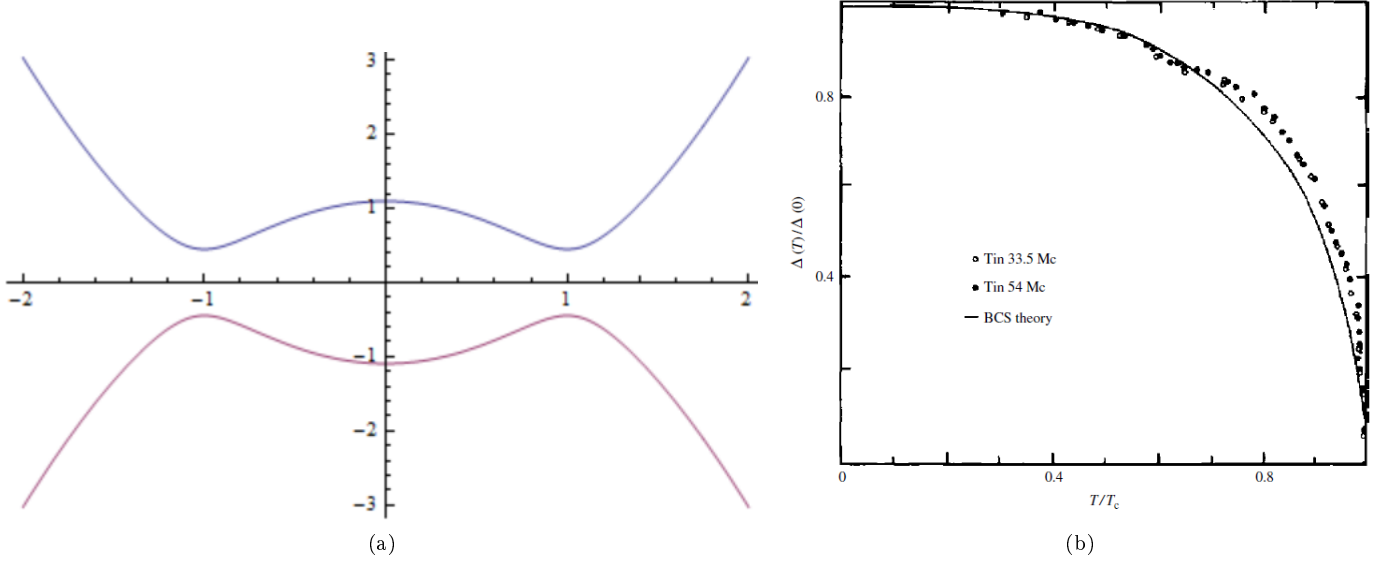

Figure 13: (a) Spectrum of BdG Hamiltonian for $\epsilon_{\mathbf{k}} = \frac{k^2}{2m}$, and (b) Comparison between BCS gap equation and experimental data.

$$U \begin{pmatrix} \psi_{\mathbf{k}\uparrow} \\ \psi_{-\mathbf{k}\downarrow}^\dagger \end{pmatrix} \equiv \begin{pmatrix} c_{\mathbf{k},1} \\ c_{\mathbf{k},2} \end{pmatrix} \equiv \chi_{\mathbf{k}} . \quad (83)$$

The unitary transformation can be parametrized by

$$U = \begin{pmatrix} \cos \theta_{\mathbf{k}} & \sin \theta_{\mathbf{k}} \\ \sin \theta_{\mathbf{k}} & -\cos \theta_{\mathbf{k}} \end{pmatrix} , \quad (84)$$

where $\tan(2\theta_{\mathbf{k}}) = -\frac{\Delta}{\epsilon_{\mathbf{k}} - \mu}$, and the eigenvalues are $\lambda_{\mathbf{k}} = \sqrt{\Delta^2 + (\epsilon_{\mathbf{k}} - \mu)^2}$. In terms of these, the Hamiltonian takes the diagonal form

$$H = \frac{\Omega}{g} |\Delta|^2 + \sum_{\mathbf{k}} (\epsilon_{\mathbf{k}} - \mu) + \sum_{\mathbf{k}} \left(\lambda_{\mathbf{k}} c_{\mathbf{k},1}^\dagger c_{\mathbf{k},1} - \lambda_{\mathbf{k}} c_{\mathbf{k},2}^\dagger c_{\mathbf{k},2} \right) . \quad (85)$$

Taking $\epsilon_{\mathbf{k}} = \frac{k^2}{2m}$, we get the dispersion shown in Fig. 13a.

It is now simple to identify the ground state: it is the state in which all the negative energy states are occupied (all c_2 states) and the positive energy states are empty (all c_1 states), that is

$$|g.s.\rangle = \prod_{\mathbf{k}} c_{\mathbf{k},2}^\dagger c_{\mathbf{k},1} |0\rangle \propto \prod_{\mathbf{k}} \left(\cos \theta_{\mathbf{k}} - \sin \theta_{\mathbf{k}} \psi_{\mathbf{k}\uparrow}^\dagger \psi_{-\mathbf{k}\downarrow}^\dagger \right) |0\rangle , \quad (86)$$

where $|0\rangle$ is the vacuum of the Fock space spanned by $\psi_{k,\sigma}^\dagger$, i.e., for all k and σ , $\psi_{k,\sigma} |0\rangle = 0$, and the corresponding ground state energy is

$$E_{g.s.} = \frac{\Omega}{g} |\Delta|^2 + \sum_{\mathbf{k}} (\epsilon_{\mathbf{k}} - \mu - \lambda_{\mathbf{k}}) . \quad (87)$$

The excited states were obtained from either destroying a $c_{\mathbf{k}2} = \sin(\theta_k) \psi_{k,\uparrow} - \cos(\theta_k) \psi_{-k,\downarrow}^\dagger$ quasi-particle, or create a $c_{\mathbf{k}1} = \cos(\theta_k) \psi_{k,\uparrow} + \sin(\theta_k) \psi_{-k,\downarrow}^\dagger$ quasi-particle - both with an energy cost of $\lambda_{\mathbf{k}}$. Crucially, there is a gap Δ to excitations. This gap is essential for superconductivity. Recall that Δ was defined as the expectation value $\Delta = \frac{g}{\Omega} \sum_{\mathbf{k}} \langle \Omega_s | \psi_{-\mathbf{k},\downarrow} \psi_{\mathbf{k}\uparrow} | \Omega_s \rangle$. We are now in a position to write a self-consistent equation for it. All we need to do is to write the $\psi_{k,\sigma}$'s in terms of the $c_{k,i}$'s for which it is easy to compute. We find

$$\Delta = \frac{g}{\Omega} \sum_{\mathbf{k}} \langle \Omega_s | \psi_{-\mathbf{k},\downarrow} \psi_{\mathbf{k}\uparrow} | \Omega_s \rangle = -\frac{1}{2} \frac{g}{\Omega} \sum_{\mathbf{k}} \sin(2\theta_{\mathbf{k}}) = \frac{g}{\Omega} \sum_{\mathbf{k}} \frac{\Delta}{2\lambda_{\mathbf{k}}} . \quad (88)$$

By transforming the sum over \mathbf{k} into an integral over energy, using the density of states $n(\xi)$, and recalling that the attractive interaction occurs only at a thin shell of order ω_D around the Fermi-energy, we write

$$1 = \frac{g}{2} \int_{-\omega_D}^{\omega_D} d\xi \frac{n(\xi)}{\sqrt{\Delta^2 + \xi^2}} \approx gn(0) \int_0^{\omega_D} \frac{d\xi}{\sqrt{\Delta^2 + \xi^2}} = gn(0) \sinh^{-1} \left(\frac{\omega_D}{\Delta} \right). \quad (89)$$

We can solve this for Δ , assuming that it is small compared to ω_D , finding

$$\Delta \approx 2\omega_D e^{-\frac{1}{gn(0)}}, \quad (90)$$

which is indeed much smaller than ω_D .

Finally, it is instructive to find the critical temperature from this formalism. To do this we need to write the self-consistency equation at finite temperatures. We can use the machinery we already have and write Δ as a sum of Matsubara frequencies using the coherent state path integral formulation. However, since we understand the excitations of the problem [85](#), we can do something simpler and immediately write

$$\langle c_{\mathbf{k}1}^\dagger c_{\mathbf{k}1} \rangle = n_F(\lambda_{\mathbf{k}}), \quad (91)$$

$$\langle c_{\mathbf{k}2}^\dagger c_{\mathbf{k}2} \rangle = 1 - n_F(\lambda_{\mathbf{k}}). \quad (92)$$

Plugging this into the definition of Δ , we get the finite temperature self consistent equation

$$\Delta = \frac{g}{\Omega} \sum_{\mathbf{k}} \langle \psi_{-\mathbf{k},\downarrow} \psi_{\mathbf{k}\uparrow} \rangle = \frac{g\Delta}{2\Omega} \sum_{\mathbf{k}} \frac{1 - 2n_F(\lambda_{\mathbf{k}})}{\lambda_{\mathbf{k}}} = \frac{g\Delta}{2\Omega} \sum_{\mathbf{k}} \frac{\tanh\left(\frac{\beta\lambda_{\mathbf{k}}}{2}\right)}{\lambda_{\mathbf{k}}}, \quad (93)$$

$$\Rightarrow 1 = \frac{g}{2\Omega} \sum_{\mathbf{k}} \frac{\tanh\left(\frac{\beta\lambda_{\mathbf{k}}}{2}\right)}{\lambda_{\mathbf{k}}}. \quad (94)$$

As before, we will transform the sum over \mathbf{k} into an integral over energy, again using the density of states $n(\xi)$ to obtain the well-known BCS gap equation

$$1 = gn(0) \int_0^{\omega_D} d\xi \frac{\tanh\left(\frac{\beta\sqrt{\Delta^2 + \xi^2}}{2}\right)}{\sqrt{\Delta^2 + \xi^2}}. \quad (95)$$

A comparison between this mean-field approximate solution and experimental measurements is shown in [Fig.13b](#).

Above the critical temperature $\Delta = 0$, and close to the critical temperature, on the superconducting side, $\Delta \approx 0$. Therefore, We can now find the critical temperature by setting $\Delta = 0$ into the gap equation. We find

$$1 = gn(0) \int_0^{\omega_D} d\xi \frac{\tanh\left(\frac{\beta\xi}{2}\right)}{\xi},$$

$$\Rightarrow T_c = C\omega_D e^{-\frac{1}{gn(0)}}, \quad (96)$$

where C is some numerical factor of order 1.

To summarize this part, we now have a microscopic theory that explains the condensation of pairs and the emerging gap to excitations. However, this picture doesn't actually allow us to find the electromagnetic response of the system. To capture this part, we need to include an additional degree of freedom in our picture: the Goldstone mode associated with changing the phase of Δ . Such a treatment necessarily goes beyond the above mean field treatment, which treats Δ as a constant. This is the focus of the next section.

9.3 Deriving the Ginzburg-Landau theory for superconductivity

To make contact with the phenomenological analysis, and include the phase mode in the analysis, we turn to derive the Ginzburg-Landau functional from the microscopics using the Hubbard-Stratonovich transformation. This is very similar in spirit to what we already saw in the second tutorial when we discussed magnetism.

The partition function is given by

$$\mathcal{Z} = \int \mathcal{D} [\bar{\psi}, \psi] e^{-\int_0^\beta d\tau dx \{ \sum_\sigma \bar{\psi}_\sigma [\partial_\tau + ie\phi + \frac{1}{2m} (-i\nabla - e\mathbf{A})^2 - \mu] \psi_\sigma - g \bar{\psi}_\uparrow \bar{\psi}_\downarrow \psi_\downarrow \psi_\uparrow \} } , \quad (97)$$

where we have introduced coupling to the electromagnetic field in the form of the minimal coupling: $\partial_\tau \rightarrow \partial_\tau + ie\phi$, and $-i\nabla \rightarrow -i\nabla - e\mathbf{A}$. The first step towards obtaining the Ginzburg-Landau theory is to decouple the interacting term by introducing a Hubbard-Stratonovich field Δ

$$e^{\int_0^\beta d\tau \int dx g \bar{\psi}_\uparrow \bar{\psi}_\downarrow \psi_\downarrow \psi_\uparrow} \sim \int \mathcal{D} [\bar{\Delta}, \Delta] e^{-\int_0^\beta d\tau \int dx \left[\frac{|\Delta|^2}{g} - (\bar{\Delta} \psi_\downarrow \psi_\uparrow + \Delta \bar{\psi}_\uparrow \bar{\psi}_\downarrow) \right]} . \quad (98)$$

The resulting action is identical to the mean-field action we had in the previous section *if* we treat Δ as a constant field, thus interpreting it Δ as the superconducting order parameter. However, now we will not do that, but instead treat it as a dynamical field, with amplitude and phase fluctuations.

The second step is to integrate out the fermions. To do so we define the Nambu-spinor $\Psi = (\psi_\uparrow \quad \bar{\psi}_\downarrow)^T$ in terms of which the partition function is

$$\begin{aligned} \mathcal{Z} &= \int \mathcal{D} [\bar{\psi}, \psi] \mathcal{D} [\bar{\Delta}, \Delta] e^{-\mathcal{S}} , \\ \mathcal{S} &= \int_0^\beta d\tau \int dx \left[\frac{|\Delta|^2}{g} - \bar{\Psi} \mathcal{G}^{-1} \Psi \right] , \end{aligned} \quad (99)$$

$$\mathcal{G}^{-1} = \begin{pmatrix} [G^{(p)}]^{-1} & \Delta \\ \bar{\Delta} & [G^{(h)}]^{-1} \end{pmatrix} , \quad (100)$$

where

$$[G^{(p)}]^{-1} = -\partial_\tau - ie\phi - \frac{1}{2m} (-i\nabla - e\mathbf{A})^2 + \mu , \quad (101)$$

$$[G^{(h)}]^{-1} = -\partial_\tau + ie\phi + \frac{1}{2m} (i\nabla - e\mathbf{A})^2 - \mu . \quad (102)$$

Integrating out the fermions, to get an effective action for Δ is simple, and the result is

$$\begin{aligned} \mathcal{Z} &= \int \mathcal{D} [\bar{\Delta}, \Delta] e^{-\mathcal{S}} , \\ \mathcal{S} &= \int_0^\beta d\tau \int dx \left[\frac{|\Delta|^2}{g} + \log [\det (\mathcal{G}^{-1})] \right] . \end{aligned} \quad (103)$$

Again, the mean-field results can be obtained from this effective theory by deriving the equations of motion, and neglecting quantum fluctuations in Δ . Doing so will reproduce the gap equation we got in the mean-field analysis in section 2. However, here we want to go beyond mean-field by considering the effects of fluctuations. To do so We will assume that Δ is small, which is true close to the transition, and expand $\log [\det (\mathcal{G}^{-1})] = \text{tr} [\log (\mathcal{G}^{-1})]$ to lowest orders in Δ . First we write

$$\mathcal{G}^{-1} = \mathcal{G}_0^{-1} + \hat{\Delta} = \mathcal{G}_0^{-1} (1 + \mathcal{G}_0 \hat{\Delta}) , \quad (104)$$

where $\mathcal{G}_0^{-1} \equiv \mathcal{G}^{-1}(\Delta = 0)$, and $\hat{\Delta} = \begin{pmatrix} 0 & \Delta \\ \bar{\Delta} & 0 \end{pmatrix}$, such that

$$\begin{aligned} \text{tr} [\log (\mathcal{G}^{-1})] &= \text{tr} [\log (\mathcal{G}_0^{-1})] + \text{tr} [\log (1 + \mathcal{G}_0 \hat{\Delta})] \\ &= \text{tr} [\log (\mathcal{G}_0^{-1})] - \sum_{n=0}^{\infty} \frac{1}{2n} \text{tr} \left[(\mathcal{G}_0 \hat{\Delta})^{2n} \right] . \end{aligned} \quad (105)$$

We will not calculate the traces here, but those who are interested in such details are referred to Altland & Simons, chapter 6. Neglecting temporal fluctuations (making it a semi-classical Ginzburg-Landau theory) the result is

$$\mathcal{S}_{GL} = \beta \int dx \left[\frac{T}{2} |\Delta|^2 + \frac{c}{2} |(\partial_x - 2ie\mathbf{A}) \Delta|^2 + u |\Delta|^4 \right] , \quad (106)$$

with $r = n \frac{T-T_c}{T_c}$. This is exactly the phenomenological theory you saw in class.

Let's see how the unique experimental properties of superconductors arise from this action. Below T_c we have $r < 0$ so the potential $\frac{r}{2} |\Delta|^2 + u |\Delta|^4$ has a minimum at $|\Delta|^2 = \sqrt{\frac{-r}{4u}} = \Delta_0^2$. However, the phase of Δ , i.e., the Goldstone mode, is not determined by the potential. Therefore, we write $\Delta = e^{2i\theta} \Delta_0$ in the Ginzburg-Landau action to get

$$\mathcal{S}_{GL} = 2c\Delta_0^2\beta \int dx (\partial_x \theta - e\mathbf{A})^2 . \quad (107)$$

We want to find the electromagnetic response of the system, so we need to treat it as dynamical field. Therefore, we should also add its kinetic term $\mathcal{S}_{Maxwell} = \frac{\beta}{2} \int dx (\nabla \times \mathbf{A})^2$ (assuming $\phi = 0$, and the field is static), such that the total action is

$$\frac{\mathcal{S}[A, \theta]}{\beta} = \int dx \left[2c\Delta_0^2 (\partial\theta - e\mathbf{A})^2 + \frac{1}{2} (\nabla \times \mathbf{A})^2 \right] . \quad (108)$$

In order to get an effective action for the gauge field A we integrate over the Goldstone mode. You already saw that explicitly in class, so I will not repeat this here, but the result is that after integrating out θ , the electromagnetic field acquires a mass (Higgs mechanism)

$$\frac{\mathcal{S}[A]}{\beta} = \frac{1}{2} \int dx \left[\frac{\rho_0}{m} \mathbf{A}^2 + \partial_i \mathbf{A} \partial_i \mathbf{A} \right] , \quad (109)$$

where we have adopted the notations used in class. Deriving the equations of motion, we get $\frac{\rho_0}{m} \mathbf{A} = \nabla^2 \mathbf{A}$, and taking the curl we reproduce the London equation

$$\frac{\rho_0}{m} \mathbf{B} = \nabla^2 \mathbf{B} , \quad (110)$$

which was discussed in class. In particular, it was already shown that it results in the decay of the magnetic field as we go into the bulk of the superconductor.

The second effect we want to see is the zero DC resistivity. To do that, we find the electric current

$$\mathbf{j}(\mathbf{r}) = \frac{\delta}{\delta \mathbf{A}(\mathbf{r})} \int dx \frac{\rho_0}{2m} \mathbf{A}^2 = \frac{\rho_0}{m} \mathbf{A} \quad (111)$$

Taking the time-derivative, working in a gauge where $\phi = 0$ and $\mathbf{E} = -i\partial_\tau \mathbf{A}$ we find that the electric field satisfies

$$\mathbf{E} = -i \frac{m}{\rho_0} \partial_\tau \mathbf{j} . \quad (112)$$

Therefore, for a constant DC current there will be no electric field. A system with a finite DC current and zero electric field has, by definition, zero resistivity. This can be seen from Ohm's law

$$\begin{aligned} j &= \sigma E \\ \Rightarrow E &= \frac{1}{\sigma} j , \end{aligned} \quad (113)$$

For a finite j , in order to get $E = 0$ we need $\sigma \rightarrow \infty$.

10 Supplementary topics in superconductivity (Tutorial)

10.1 Phonon mediated attractive interaction for electrons

In the previous Tutorial we argued that since electron dynamics are governed by ϵ_F and phonon dynamics by $\omega_D \ll \epsilon_F$, phonons can mediate attractive interaction between electrons. The picture was that an electron passing through some position in space will distort the lattice there by means of Coulomb attraction, and since the lattice relaxation is very slow (compared to the dynamics of the electrons), other electrons will be drawn to the distorted position after the original electron left it. Therefore the instantaneous repulsion between electron is complemented with a retarded attraction through the lattice distortion.

In this section of the tutorial we will support this qualitative picture with a quantitative analysis of an electron-phonon Hamiltonian. We will derive an effective model for the electron in which there is a retarded attractive interaction between them, due to the coupling to the phonons. To be specific, consider the following model of electrons coupled to phonons

$$H = \sum_{\mathbf{k},\sigma} \xi_k c_{\mathbf{k},\sigma}^\dagger c_{\mathbf{k},\sigma} + \sum_{\mathbf{q},\mu} \omega_q b_{\mathbf{q},\mu}^\dagger b_{\mathbf{q},\mu} + \lambda \int d\mathbf{r} \rho(\mathbf{r}) \nabla \cdot \mathbf{u}(\mathbf{r}) + H_{\text{int}} , \quad (114)$$

where $\rho(\mathbf{r}) = \sum_{\sigma} \psi_{\sigma}^\dagger(\mathbf{r}) \psi_{\sigma}(\mathbf{r})$ is the electron density, ω_q is the phonon dispersion, $\xi_k = \epsilon_k - \epsilon_F$ is the electron dispersion. The electron-phonon couple through the induced charge $\mathbf{P} = -\nabla \cdot \mathbf{u}(\mathbf{r})$, where $\mathbf{u}(\mathbf{r})$ is the lattice displacement field, governed by the coupling constant λ . We also include an unspecified electron-electron interaction, H_{int} , e.g., Coulomb repulsion. We wish to integrate out the phonons to obtain an effective theory for the electrons, in which the phonons are encoded through an effective interaction between electrons.

To do so we first write the coupling term in momentum space and in terms of phonon creation and annihilation operators

$$\begin{aligned} \rho(\mathbf{r}) &= \frac{1}{\sqrt{V}} \sum_{\mathbf{q}} \rho_{\mathbf{q}} e^{i\mathbf{q} \cdot \mathbf{r}} , \\ \Rightarrow \lambda \int d\mathbf{r} \rho(\mathbf{r}) \nabla \cdot \mathbf{u}(\mathbf{r}) &= \lambda \sum_{\mathbf{q}} q_{\mu} u_{\mathbf{q},\mu} \rho_{-\mathbf{q}} = \lambda \sum_{\mathbf{q}} \frac{i q_{\mu}}{\sqrt{2m\omega_q}} (b_{-\mathbf{q},\mu}^\dagger + b_{\mathbf{q},\mu}) \rho_{-\mathbf{q}} , \end{aligned} \quad (115)$$

where $\rho_{\mathbf{q}} = \frac{1}{\sqrt{V}} \sum_{\mathbf{k},\sigma} \bar{\psi}_{\mathbf{k},\sigma} \psi_{\mathbf{k}+\mathbf{q},\sigma}$, is not the electron density in mode \mathbf{q} but rather the \mathbf{q} mode of the electron density in real space, and m is the ion mass. In order to integrate out the phonons, we go to the partition function and the action

$$\mathcal{Z} = \int \mathcal{D}[\bar{\psi}, \psi] e^{-\mathcal{S}} \quad (116a)$$

$$\begin{aligned} \mathcal{S} &= \sum_{\mathbf{k},n,\sigma} \bar{\psi}_{\mathbf{k},n,\sigma} (-i\omega_n + \xi_k) \psi_{\mathbf{k},n,\sigma} + \mathcal{S}_{\text{int}} \\ &+ \underbrace{\sum_{\mathbf{q},l,\mu} (-i\omega_l + \omega_q) \phi_{\mathbf{q},l,\mu}^* \phi_{\mathbf{q},l,\mu} + \lambda \sum_{q,l,\mu} \frac{i q_{\mu}}{\sqrt{2m\omega_q}} (\phi_{\mathbf{q},l,\mu} + \phi_{-\mathbf{q},-l,\mu}^*) \rho_{-\mathbf{q},-l}}_{\mathcal{S}_{\text{ph}}} , \end{aligned} \quad (116b)$$

where ω_n are fermionic Matsubara frequencies, ω_l are bosonic Matsubara frequencies. Let us concentrate on the phononic part of the action and notice that it is quadratic in the phonons. We can therefore complete the square and integrate them out to get an effective action for the fermions. Completing the square requires first writing the phononic action in a ‘‘symmetrized’’ way

$$\begin{aligned} \mathcal{S}_{\text{ph}} &= \frac{1}{2} \sum_{\mathbf{q},l,\mu} \begin{pmatrix} \phi_{\mathbf{q},l,\mu}^* & \phi_{-\mathbf{q},-l,\mu} \end{pmatrix} \begin{pmatrix} -i\omega_l + \omega_q & 0 \\ 0 & i\omega_l + \omega_q \end{pmatrix} \begin{pmatrix} \phi_{\mathbf{q},l,\mu} \\ \phi_{-\mathbf{q},-l,\mu}^* \end{pmatrix} \\ &+ \frac{1}{2} \sum_{\mathbf{q},l,\mu} \left[\begin{pmatrix} \phi_{\mathbf{q},l,\mu}^* & \phi_{-\mathbf{q},-l,\mu} \end{pmatrix} \begin{pmatrix} \frac{-i\lambda q_{\mu}}{\sqrt{2m\omega_q}} \rho_{\mathbf{q},l} \\ \frac{-i\lambda q_{\mu}}{\sqrt{2m\omega_q}} \rho_{\mathbf{q},l} \end{pmatrix} + \begin{pmatrix} \frac{i\lambda q_{\mu}}{\sqrt{2m\omega_q}} \rho_{-\mathbf{q},-l} & \frac{i\lambda q_{\mu}}{\sqrt{2m\omega_q}} \rho_{-\mathbf{q},-l} \end{pmatrix} \begin{pmatrix} \phi_{\mathbf{q},l,\mu} \\ \phi_{-\mathbf{q},-l,\mu}^* \end{pmatrix} \right] , \end{aligned} \quad (117)$$

where to get this we wrote the action as a sum of two copies of itself (introducing an overall factor of half), and changed $\mathbf{q} \rightarrow -\mathbf{q}$ and $\omega_l \rightarrow -\omega_l$ in one copy. We now notice that the action is of the form

$$\mathcal{S}_{\text{ph}} = \frac{1}{2} \sum_{\mathbf{q}, l, \mu} \left[\vec{\Phi}_{\mathbf{q}, l, \mu}^\dagger \mathbf{A} \vec{\Phi}_{\mathbf{q}, l, \mu} + \vec{\Phi}_{\mathbf{q}, l, \mu}^\dagger \cdot \vec{b}_{\mathbf{q}, l, \mu} + \vec{b}_{\mathbf{q}, l, \mu}^\dagger \cdot \vec{\Phi}_{\mathbf{q}, l, \mu} \right], \quad (118)$$

for which completing the square and integrating out the phonons is easy

$$\begin{aligned} \mathcal{S}_{\text{ph}} &= \frac{1}{2} \sum_{\mathbf{q}, l, \mu} \left[\vec{\Phi}_{\mathbf{q}, l, \mu}^\dagger \mathbf{A} \vec{\Phi}_{\mathbf{q}, l, \mu} + \vec{\Phi}_{\mathbf{q}, l, \mu}^\dagger \cdot \vec{b}_{\mathbf{q}, l, \mu} + \vec{b}_{\mathbf{q}, l, \mu}^\dagger \cdot \vec{\Phi}_{\mathbf{q}, l, \mu} \right] \\ &= \frac{1}{2} \sum_{\mathbf{q}, l, \mu} \left(\vec{\Phi}_{\mathbf{q}, l, \mu}^\dagger + \vec{b}_{\mathbf{q}, l, \mu}^\dagger \mathbf{A}^{-1} \right) \mathbf{A} \left(\vec{\Phi}_{\mathbf{q}, l, \mu} + \mathbf{A}^{-1} \vec{b}_{\mathbf{q}, l, \mu} \right) - \frac{1}{2} \sum_{\mathbf{q}, l, \mu} \vec{b}_{\mathbf{q}, l, \mu}^\dagger \mathbf{A}^{-1} \vec{b}_{\mathbf{q}, l, \mu} \\ &\quad \sim -\frac{1}{2} \sum_{\mathbf{q}, l, \mu} \vec{b}_{\mathbf{q}, l, \mu}^\dagger \mathbf{A}^{-1} \vec{b}_{\mathbf{q}, l, \mu} \\ &= -\frac{1}{2} \sum_{\mathbf{q}, l, \mu} \begin{pmatrix} \frac{i\lambda q_\mu}{\sqrt{2m\omega_q}} \rho_{-\mathbf{q}, -l} & \frac{i\lambda q_\mu}{\sqrt{2m\omega_q}} \rho_{-\mathbf{q}, -l} \\ \frac{1}{-i\omega_l + \omega_q} & 0 \\ 0 & \frac{1}{i\omega_l + \omega_q} \end{pmatrix} \begin{pmatrix} \frac{-i\lambda q_\mu}{\sqrt{2m\omega_q}} \rho_{\mathbf{q}, l} \\ \frac{-i\lambda q_\mu}{\sqrt{2m\omega_q}} \rho_{\mathbf{q}, l} \end{pmatrix} \\ &= -\frac{1}{2} \sum_{\mathbf{q}, l} \frac{\lambda^2 q^2}{2m\omega_q} \rho_{\mathbf{q}, l} \left[\frac{1}{-i\omega_l + \omega_q} + \frac{1}{i\omega_l + \omega_q} \right] \rho_{-\mathbf{q}, -l} \\ &= -\frac{1}{2} \sum_{\mathbf{q}, l} \frac{\lambda^2 q^2}{2m(\omega_l^2 + \omega_q^2)} \rho_{\mathbf{q}, l} \rho_{-\mathbf{q}, -l}. \end{aligned} \quad (119)$$

Therefore, the effective interaction for the electrons is

$$\mathcal{S}_{\text{eff}} = \sum_{\mathbf{k}, n, \sigma} \bar{\psi}_{\mathbf{k}, n, \sigma} (-i\omega_n + \xi_{\mathbf{k}}) \psi_{\mathbf{k}, n, \sigma} + \sum_{\mathbf{q}, l} \left[g_0(\mathbf{q}) - \frac{1}{2} \frac{\lambda^2 q^2}{2m(\omega_l^2 + \omega_q^2)} \right] \rho_{\mathbf{q}, l} \rho_{-\mathbf{q}, -l}, \quad (120)$$

where $g_0(\mathbf{q})$ is the original electron-electron interaction (say Coulomb repulsion). The effective electron-electron has also a contribution from the phonons, and is given by

$$g_{\text{eff}}(\mathbf{q}, i\omega_l) = g_0(\mathbf{q}) - \frac{1}{2} \frac{\lambda^2 q^2}{2m(\omega_l^2 + \omega_q^2)}. \quad (121)$$

Wick rotating the effective interaction to real time, i.e., taking $\omega_l \rightarrow -i\omega - \delta$, we find that for every momentum mode \mathbf{q} the phonon-mediated correction to the interaction is attractive at low enough frequency: $\omega < \omega_q$. Since acoustic phonons have $\omega_q \propto q$, it is either high energy acoustic phonons, or, more commonly, optical phonons that generate the attractive interaction. We can thus estimate $\omega_q \sim \omega_D$ and the effective interaction

$$g(\mathbf{q}, \omega) = g_0(\mathbf{q}) - \frac{1}{2} \frac{\lambda^2 q^2}{2m(\omega_D^2 - \omega^2)} \quad (122)$$

is still repulsive for $\omega > \omega_D$, but may become attractive for $\omega < \omega_D$ (if this negative contribution overcomes the original repulsive interaction. This dependence on ω is exactly the retardation effect.

10.2 RG equation for the Cooper channel

In this section we will begin from a generic interacting Hamiltonian and derive the RG equation governing the interactions in the Cooper channel. We will disregard all other channels, and thus won't be able to say anything about what happens there. Therefore, our picture will be incomplete, and we will not know what actually happens to the system. However, we will be able to say if (and when) the Cooper channel is important.

We begin our discussion from the following Hamiltonian of electrons with density-density interaction $V(\mathbf{r}_1 - \mathbf{r}_2)$, e.g., Coulomb repulsion:

$$H = H_0 + H_{\text{int}}, \quad (123a)$$

$$H_0 = \int d\mathbf{r} \sum_{\sigma} \left[\psi_{\sigma}^{\dagger}(\mathbf{r}) \left(-\frac{\nabla^2}{2m} - \mu \right) \psi_{\sigma}(\mathbf{r}) \right] , \quad (123b)$$

$$H_{\text{int}} = \frac{1}{2} \int d\mathbf{r}_1 d\mathbf{r}_2 \sum_{\sigma_1, \sigma_2} \left[\psi_{\sigma_1}^{\dagger}(\mathbf{r}_1) \psi_{\sigma_2}^{\dagger}(\mathbf{r}_2) V(\mathbf{r}_1 - \mathbf{r}_2) \psi_{\sigma_2}(\mathbf{r}_2) \psi_{\sigma_1}(\mathbf{r}_1) \right] . \quad (123c)$$

We define the (bosonic) operator creating two electrons with arbitrary spins at arbitrary positions

$$\Phi_{\sigma_1, \sigma_2}^{\dagger}(\mathbf{r}_1, \mathbf{r}_2) = \psi_{\sigma_1}^{\dagger}(\mathbf{r}_1) \psi_{\sigma_2}^{\dagger}(\mathbf{r}_2) , \quad (124)$$

and its hermitian conjugate, annihilating two such fermions. Transforming to the center of mass coordinate $\mathbf{R} = \frac{\mathbf{r}_1 + \mathbf{r}_2}{2}$ and relative coordinate $\mathbf{r} = \mathbf{r}_1 - \mathbf{r}_2$ we can write

$$\Phi_{\sigma_1, \sigma_2}^{\dagger}(\mathbf{r}, \mathbf{R}) = \psi_{\sigma_1}^{\dagger}\left(\mathbf{R} + \frac{\mathbf{r}}{2}\right) \psi_{\sigma_2}^{\dagger}\left(\mathbf{R} - \frac{\mathbf{r}}{2}\right) , \quad (125)$$

in terms of which the interaction Hamiltonian is

$$H_{\text{int}} = \frac{1}{2} \int d\mathbf{r} d\mathbf{R} V(\mathbf{r}) \Phi_{\sigma_1, \sigma_2}^{\dagger}(\mathbf{r}, \mathbf{R}) \Phi_{\sigma_1, \sigma_2}(\mathbf{r}, \mathbf{R}) . \quad (126)$$

Notice that we have written the interaction in a suggestive way, namely, focusing on the cooper channel.⁵ For short-range interactions, since we are interested in long-wavelength physics, we can approximate $V(\mathbf{r}) = g\delta(\mathbf{r})$ to obtain

$$H_{\text{int}} = g \int d\mathbf{R} \Phi_{\uparrow, \downarrow}^{\dagger}(0, \mathbf{R}) \Phi_{\uparrow, \downarrow}(0, \mathbf{R}) , \quad (127)$$

where we have specified to electrons of opposite spin since for $r = 0$ same spin contributions vanish. It is important to note that even for the long-range Coulomb interaction this approximation is valid. The reason is that in metals, where the fermions form a Fermi surface state (as in H_0), the long-range Coulomb interaction is screened, and becomes effectively short-range.

We now go to the partition function, and perform a Hubbard-Stratonovich transformation, introducing the bosonic field $\Delta(R, \tau)$ which decouples the interactions in the Cooper channel to get

$$\mathcal{Z} = \int \mathcal{D} [\bar{\psi}, \psi, \bar{\Delta}, \Delta] \exp[-\mathcal{S}_{\text{H.S.}}] , \quad (128a)$$

$$\begin{aligned} \mathcal{S}_{\text{H.S.}} &= \int d\mathbf{R} d\tau \sum_{\sigma} \bar{\psi}_{\sigma}(\mathbf{R}, \tau) \left[\partial_{\tau} - \frac{\nabla^2}{2m} - \mu \right] \psi_{\sigma}(\mathbf{R}, \tau) + \frac{1}{g} \int d\mathbf{R} d\tau \bar{\Delta}(\mathbf{R}, \tau) \Delta(\mathbf{R}, \tau) \\ &\quad + \int d\mathbf{R} d\tau \left[i\bar{\Delta}(\mathbf{R}, \tau) \psi_{\downarrow}(\mathbf{R}, \tau) \psi_{\uparrow}(\mathbf{R}, \tau) + i\Delta(\mathbf{R}, \tau) \bar{\psi}_{\uparrow}(\mathbf{R}, \tau) \bar{\psi}_{\downarrow}(\mathbf{R}, \tau) \right] \\ &= \frac{1}{g} \sum_{\mathbf{Q}, \omega_m} \bar{\Delta}(\mathbf{Q}, \omega_m) \Delta(\mathbf{Q}, \omega_m) + \sum_{\sigma, \mathbf{k}, \omega_n} (-i\omega_n + \xi_k) \bar{\psi}_{\sigma}(\mathbf{k}, \omega_n) \psi_{\sigma}(\mathbf{k}, \omega_n) \\ &\quad + \frac{i}{\sqrt{\beta V}} \sum_{\mathbf{k}, \omega_n} \sum_{\mathbf{Q}, \omega_m} \bar{\Delta}(\mathbf{Q}, \omega_m) \psi_{\downarrow}(\mathbf{Q} - \mathbf{k}, \omega_m - \omega_n) \psi_{\uparrow}(\mathbf{k}, \omega_n) \\ &\quad + \frac{i}{\sqrt{\beta V}} \sum_{\mathbf{k}, \omega_n} \sum_{\mathbf{Q}, \omega_m} \Delta(\mathbf{Q}, \omega_m) \bar{\psi}_{\uparrow}(\mathbf{k}, \omega_n) \bar{\psi}_{\downarrow}(\mathbf{Q} - \mathbf{k}, \omega_m - \omega_n) , \end{aligned} \quad (128b)$$

where $\xi_k = \frac{k^2}{2m} - \epsilon_F$. We are interested in the low-energy physics, and so we expand in \mathbf{Q} and ω_m keeping only the zeroth-order term. Effectively this means setting $\mathbf{Q} = 0$ and $\omega_m = 0$ to get

$$\begin{aligned} \mathcal{S}_{\text{H.S.}} &= \frac{1}{g} \bar{\Delta} \Delta + \sum_{\sigma, \mathbf{k}, \omega_n} (-i\omega_n + \xi_k) \bar{\psi}_{\sigma}(\mathbf{k}, \omega_n) \psi_{\sigma}(\mathbf{k}, \omega_n) \\ &\quad + \frac{i}{\sqrt{\beta V}} \sum_{\mathbf{k}, \omega_n} \bar{\Delta} \psi_{\downarrow}(-\mathbf{k}, -\omega_n) \psi_{\uparrow}(\mathbf{k}, \omega_n) + \frac{i}{\sqrt{\beta V}} \sum_{\mathbf{k}, \omega_n} \Delta \bar{\psi}_{\uparrow}(\mathbf{k}, \omega_n) \bar{\psi}_{\downarrow}(-\mathbf{k}, -\omega_n) , \end{aligned} \quad (129)$$

⁵Everything we did so far is of course exact, and so even if the cooper channel is not the important channel, doing so is still correct. However, going forward with the derivation requires some assumptions which we will perform on this channel. By making these assumptions on this specific form of the Hamiltonian we are essentially focus on the cooper channel.

This step is where we specifically consider the physics of the cooper channel. Up to now everything we did was exact and could capture any physical effect. In this step we focus on the cooper channel, analyzing what happens specifically there ⁶.

To perform the RG analysis we introduce a high-energy cutoff Ω for the electrons, i.e., $|\xi_k| \leq \Omega$. The cutoff dependent action takes to form

$$\begin{aligned} \mathcal{S}(\Omega) &= \frac{1}{g(\Omega)} \bar{\Delta} \Delta + \sum_{\sigma, \omega_n} \sum_{|\xi_k| < \Omega} (-i\omega_n + \xi_k) \bar{\psi}_{\sigma, \mathbf{k}, \omega_n} \psi_{\sigma, \mathbf{k}, \omega_n} \\ &+ \frac{i}{\sqrt{\beta V}} \sum_{\omega_n} \sum_{|\xi_k| < \Omega} [\bar{\Delta} \psi_{\downarrow, -\mathbf{k}, -\omega_n} \psi_{\uparrow, \mathbf{k}, \omega_n} + \Delta \bar{\psi}_{\uparrow, \mathbf{k}, \omega_n} \bar{\psi}_{\downarrow, -\mathbf{k}, -\omega_n}] \\ &= \frac{1}{g(\Omega)} \bar{\Delta} \Delta + \sum_{\sigma, \omega_n} \sum_{|\xi_k| < \Omega} \begin{pmatrix} \bar{\psi}_{\uparrow, \mathbf{k}, \omega_n} & \psi_{\downarrow, -\mathbf{k}, -\omega_n} \end{pmatrix} \begin{pmatrix} -i\omega_n + \xi_k & \frac{i}{\sqrt{\beta V}} \Delta \\ \frac{i}{\sqrt{\beta V}} \bar{\Delta} & -i\omega_n - \xi_k \end{pmatrix} \begin{pmatrix} \psi_{\uparrow, \mathbf{k}, \omega_n} \\ \bar{\psi}_{\downarrow, -\mathbf{k}, -\omega_n} \end{pmatrix}. \end{aligned} \quad (130)$$

We now split the action into a low energy part, $|\xi_k| \leq \Omega - d\Omega$, and high energy part, $\Omega - d\Omega < |\xi_k| \leq \Omega$, and integrate out the high energy electrons to obtain the action at the scale $\Omega - d\Omega$

$$\begin{aligned} \mathcal{Z} &= \int_{|\xi_k| \leq \Omega} \mathcal{D}[\bar{\psi}, \psi] \exp[-\mathcal{S}(\Omega)] = \int_{|\xi_k| \leq \Omega - d\Omega} \mathcal{D}[\bar{\psi}, \psi] \int_{\Omega - d\Omega < |\xi_k| \leq \Omega} \mathcal{D}[\bar{\psi}, \psi] \exp[-\mathcal{S}(\Omega)] \\ &= \int_{|\xi_k| \leq \Omega - d\Omega} \mathcal{D}[\bar{\psi}, \psi] \exp[-\mathcal{S}(\Omega - d\Omega)] \end{aligned} \quad (131a)$$

$$\begin{aligned} \mathcal{S}(\Omega - d\Omega) &= \frac{1}{g(\Omega)} \bar{\Delta} \Delta - \sum_{\sigma, \omega_n} \sum_{\Omega - d\Omega < |\xi_k| \leq \Omega} \log \left[-\omega_n^2 - \xi_k^2 + \frac{1}{\sqrt{\beta V}} \bar{\Delta} \Delta \right] \\ &+ \sum_{\omega_n} \sum_{|\xi_k| < \Omega - d\Omega} \begin{pmatrix} \bar{\psi}_{\uparrow, \mathbf{k}, \omega_n} & \psi_{\downarrow, -\mathbf{k}, -\omega_n} \end{pmatrix} \begin{pmatrix} -i\omega_n + \xi_k & \frac{i}{\sqrt{\beta V}} \Delta \\ \frac{i}{\sqrt{\beta V}} \bar{\Delta} & -i\omega_n - \xi_k \end{pmatrix} \begin{pmatrix} \psi_{\uparrow, \mathbf{k}, \omega_n} \\ \bar{\psi}_{\downarrow, -\mathbf{k}, -\omega_n} \end{pmatrix}. \end{aligned} \quad (131b)$$

Notice that the second part is already of the same form as the original action. To proceed, and find a form similar to the original action also for the first part, we expand the logarithm and identify the coupling constant, g , at the new scale

$$\begin{aligned} &\frac{1}{g(\Omega)} \bar{\Delta} \Delta - \sum_{\omega_n} \sum_{\Omega - d\Omega < |\xi_k| \leq \Omega} \log \left[-\omega_n^2 - \xi_k^2 + \frac{1}{\beta V} \bar{\Delta} \Delta \right] \\ &= \frac{1}{g(\Omega)} \bar{\Delta} \Delta - \sum_{\omega_n} \sum_{\Omega - d\Omega < |\xi_k| \leq \Omega} \log \left[1 - \frac{1}{\beta V} \frac{\bar{\Delta} \Delta}{\omega_n^2 + \xi_k^2} \right] + \text{const} \\ &\approx \left[\frac{1}{g(\Omega)} + \frac{1}{\beta V} \sum_{\omega_n} \sum_{\Omega - d\Omega < |\xi_k| \leq \Omega} \frac{1}{\omega_n^2 + \xi_k^2} \right] \bar{\Delta} \Delta \equiv \frac{1}{g(\Omega - d\Omega)} \bar{\Delta} \Delta. \end{aligned} \quad (132)$$

So we have found the following equation describing the scale dependence of the coupling constant

$$\frac{1}{g(\Omega - d\Omega)} = \frac{1}{g(\Omega)} + \frac{1}{\beta V} \sum_{\omega_n} \sum_{\Omega - d\Omega < |\xi_k| \leq \Omega} \frac{1}{\omega_n^2 + \xi_k^2}. \quad (133)$$

The final step is to resolve the sums, by first approximating the sum over ω_n with an integral, and then transform from sum over k to integral over ξ (using the the density of states)

$$\begin{aligned} &\sum_{\omega_n} \sum_{\Omega - d\Omega < |\xi_k| \leq \Omega} \frac{1}{\beta V} \frac{1}{\omega_n^2 + \xi_k^2} \approx \frac{1}{V} \sum_{\Omega - d\Omega < |\xi_k| \leq \Omega} \int \frac{d\omega}{2\pi} \frac{1}{\omega^2 + \xi_k^2} = \frac{1}{2V} \sum_{\Omega - d\Omega < |\xi_k| \leq \Omega} \frac{1}{|\xi_k|} \\ &= \nu_0 \int_{\Omega - d\Omega}^{\Omega} \frac{d\xi}{\xi} = \nu_0 \log \left(\frac{\Omega}{\Omega - d\Omega} \right) = -\nu_0 \log \left(\frac{\Omega - d\Omega}{\Omega} \right) = -\nu_0 \log \left(1 - \frac{d\Omega}{\Omega} \right) \approx \nu_0 \frac{d\Omega}{\Omega}, \end{aligned} \quad (134)$$

⁶More generally one can decouple the Hamiltonian in many channels simultaneously, and in each of them consider the low-energy long-wavelength limit of the relevant Hubbard-Stratonovich field, to find the RG equations of that specific channel.

where ν_0 is the density of states (normalized by spin and volume) on the Fermi surface. The resulting RG equation is therefore

$$\begin{aligned} \frac{1}{g(\Lambda)} - \frac{1}{g(\Lambda - d\Lambda)} &= -\nu_0 \frac{d\Lambda}{\Lambda} \\ \Rightarrow \Lambda \frac{d}{d\Lambda} \left[\frac{1}{g(\Lambda)} \right] &= -\nu_0 \\ \Rightarrow \frac{d}{d \log(\Lambda)} \left[\frac{1}{g(\Lambda)} \right] &= -\nu_0 . \end{aligned} \quad (135)$$

The solution of the RG equation is

$$g(\Lambda) = \frac{g_0}{1 + \nu_0 g_0 \log\left(\frac{\Lambda_0}{\Lambda}\right)} , \quad (136)$$

where $g_0 = g(\Lambda_0)$. What does this mean? If the sign of g_0 is positive, namely, the interactions are repulsive then g decreases with decreasing scale Λ , making the interactions irrelevant at low energy. However, if the sign of g_0 is negative, namely, the interactions are attractive then g remains negative but grows in its absolute value, making the interactions relevant and ultimately dominant. We know that attractive interactions are a result of phonon mediated interaction between electrons, and thus occur only below $\sim \omega_D$. How can interactions in such a small energy range overcome the repulsive interaction in the much larger range? To answer this, let us look again at the RG equation (135), and integrate it from Ω_0 all the way down to ω_D

$$g(\omega_D) = \frac{g_0}{1 + \nu_0 g_0 \log\left(\frac{\Omega_0}{\omega_D}\right)} . \quad (137)$$

Ω_0 should be of the order of the Fermi energy, which is typically roughly two orders of magnitude larger than ω_D leading to $\log\left(\frac{\Omega_0}{\omega_D}\right) \sim \log\left(\frac{\epsilon_F}{\omega_D}\right) \sim 5$. Define a dimensionless interaction strength $\Gamma = \nu_0 * g$ we find that $g(\omega_D)$ is quite small

$$\Gamma(\omega_D) \sim \frac{\Gamma_0}{1 + 5\Gamma_0} \leq \frac{1}{5} , \quad (138)$$

and can thus be overcome by some weak phonon mediated attractive interaction. Therefore, at this point we add the attractive interaction due to phonons, $\Gamma'(\omega_D) = \Gamma(\omega_D) - \Gamma_{\text{ph}}$, and keep integrating the RG equation to even lower energies

$$\Gamma(\omega) = \frac{\Gamma'}{1 + \Gamma' \log\left(\frac{\omega_D}{\omega}\right)} , \quad (139)$$

where $\Gamma' \equiv \Gamma'(\omega_D) = \Gamma(\omega_D) - \Gamma_{\text{ph}}$. If indeed $\Gamma' < 0$, then $g(\omega)$ diverges (in its absolute value) as ω is reduced toward the value at which $\Gamma' \log\left(\frac{\omega_D}{\omega}\right) = -1$. This divergence is a sign of some sort of instability or phase transition. We can estimate the critical temperature using the scale at which the interactions are of order -1 (not small anymore),

$$\begin{aligned} \Gamma(T_C) = -1 &= \frac{-|\Gamma'|}{1 - |\Gamma'| \log\left(\frac{\omega_D}{T_C}\right)} , \\ \Rightarrow T_C \sim \omega_D \exp\left[-\frac{1}{|\Gamma'|}\right] &= \omega_D \exp\left[-\frac{1}{\nu_0 |g'|}\right] . \end{aligned} \quad (140)$$

This is indeed the same T_C we got from BSC theory (perhaps up to a numerical prefactor)!

11 The 2D XY Model: The Berezinskii-Kosterlitz-Thouless transition

We turn to study the XY model. This model has a global $U(1)$ symmetry, and its order parameter is therefore a planar vector $S = (S_x, S_y)$, or equivalently a complex scalar

$$\psi = S_x - iS_y.$$

A superfluid described by a complex order parameter, which has a phase and an amplitude is one example but there are many other examples, e.g. spins confined to be in a plane, having only x and y components. Below we think of a classical statistical mechanics theory (or a quantum theory at relatively high temperatures). However, the results apply directly to quantum systems by the quantum-classical mapping.

We define

$$\psi = \psi_0 e^{i\phi(r)},$$

and the corresponding classical Hamiltonian, favoring alignment of different points, is

$$H = \frac{1}{2} \int \kappa_0 (\nabla\phi)^2 d^2r. \quad (141)$$

It can be seen that the $U(1)$ symmetry of the problem is respected.

We already saw that 2D systems with a continuous symmetry do not have long range order. However, as we will see below, the system is not entirely disordered, as the correlation function decays without a characteristic length scale.

The correlation function is

$$\langle \psi^*(r)\psi(0) \rangle = \langle \psi_0 e^{i\phi(r)} \psi_0 e^{-i\phi(0)} \rangle = |\psi_0|^2 e^{-\frac{1}{2} \langle (\phi(r) - \phi(0))^2 \rangle} \quad (142)$$

with

$$\langle (\phi(r) - \phi(0))^2 \rangle = \frac{T}{\kappa_0} \int \frac{d^2k}{(2\pi)^2} |e^{i\vec{k}\cdot\vec{r}} - 1|^2 \langle \phi_{\vec{k}}^2 \rangle.$$

The last equation follows from the Fourier substitution:

$$\phi(\vec{r}) = \frac{1}{(2\pi)^2} \int e^{i\vec{k}\cdot\vec{r}} d^2k \phi_{\vec{k}}$$

and the relation:

$$\frac{1}{(2\pi)^2} \int d^2r e^{i(\vec{k}-\vec{k}')\cdot\vec{r}} = \delta^2(\vec{k} - \vec{k}')$$

Using the free Hamiltonian in Eq. (141) we find:

$$H = \kappa \frac{1}{(2\pi)^4} \int d^2r \int d^2k \int d^2k' \nabla(e^{i\vec{k}\cdot\vec{r}} \phi_{\vec{k}}) \nabla(e^{i\vec{k}'\cdot\vec{r}} \phi_{\vec{k}'}) = \kappa \frac{1}{(2\pi)^2} \int d^2k k^2 \phi_{\vec{k}} \phi_{-\vec{k}}$$

from this we can easily find the correlation function:

$$\langle \phi_{\vec{k}} \phi_{\vec{k}'} \rangle = \delta(\vec{k} - \vec{k}') \kappa \frac{1}{k^2}.$$

Using the relation

$$F(|\vec{r}|) = |e^{i\vec{k}\cdot\vec{r}} - 1|^2 = (\cos(kr) - 1)^2 + \sin^2(kr) = 1 - 2\cos(kr) + \cos^2(kr) + \sin^2(kr) = 2 - 2\cos(kr)$$

we notice that for $\vec{k}\cdot\vec{r} \ll 1$ the function $F(|\vec{r}|)$ is zero. For $kr \gg 1$, the cos terms is strongly oscillating so that the integral over it is not expected to be the leading order and we can ignore it. We can therefore approximate Eq. (142) by:

$$\langle (\phi(r) - \phi(0))^2 \rangle = \frac{2}{(2\pi)^2} \frac{T}{\kappa_0} \int_{1/r}^{1/a} \frac{2\pi k}{k^2} dk = \frac{T}{\pi\kappa_0} \log\left(\frac{r}{a}\right).$$

Here a is a short range (ultra violet) cutoff. Hence we have

$$\langle \psi^*(r)\psi(0) \rangle = |\psi_0|^2 \left(\frac{1}{r}\right)^\eta, \quad \eta = \frac{T}{2\pi\kappa_0}.$$

The fact that the correlation vanishes at large distances shows that the system is not long range ordered. If the correlations decay as a power law, the system is said to be quasi-long-range ordered.

11.1 Vortices in the XY model

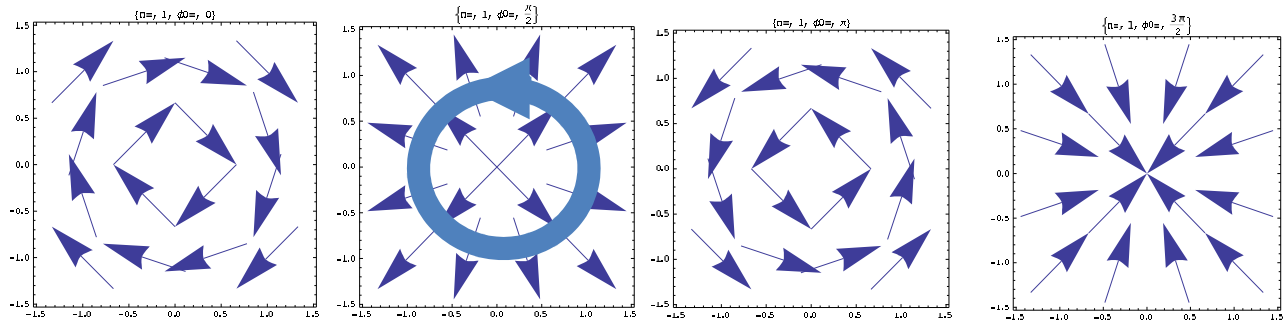

$$\phi = -n \arctan(x/y) + \phi_0$$

$$S_x = \cos \phi; S_y = \sin \phi$$

$$\vec{v} = \vec{\nabla} \phi$$

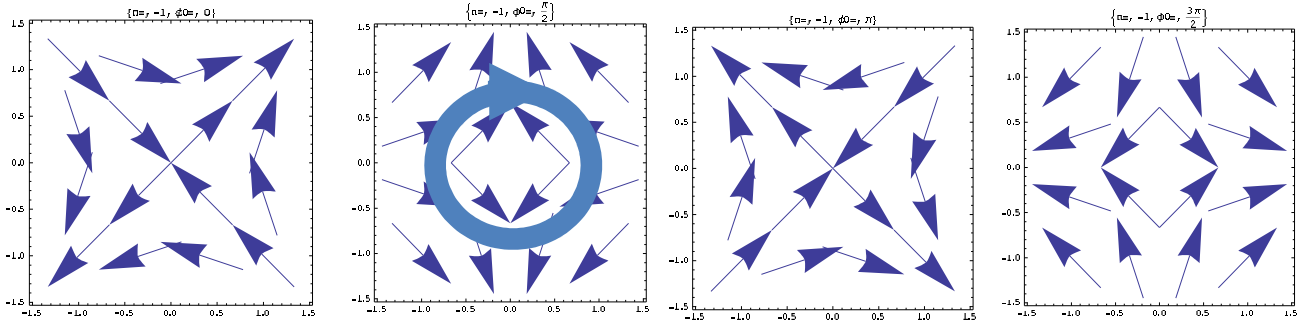

Figure 14: vortex and anti vortex in the spin configuration $\psi = \psi_0 e^{i\phi} = S_x - iS_y$ denoted by arrows in the spin direction and in the velocity $\nabla\phi$ denoted by bold lines

For $\psi \neq 0$, we define a velocity field

$$\nabla\phi(r) = v(r)$$

From the fact that $e^{i\phi}$ is single valued, we have a condition for an integral around any point:

$$\oint v(r)dr = 2\pi n.$$

If the contour does not enclose a vortex, n is zero. In general, the integer n counts the number of windings the phase ϕ does, or equivalently, the number of vortices inside the contour:

$$n = \frac{1}{2\pi} \oint v(r)dr.$$

If the contour encloses a number of vortices, we get the generalized relation

$$\oint v \cdot dr = \sum_i 2\pi N_i \equiv 2\pi N_c, \quad (143)$$

where N_i represents the charges of the various vortices, and N_c is the total topological charge.

We can define a local vortex charge density

$$N(r) = \sum_i N_i \delta(r - R_i). \quad (144)$$

Using this definition, and Eq. 143, we get

$$N_c = \int ds N(r) = \frac{1}{2\pi} \oint v(r)dr = \frac{1}{2\pi} \int \nabla \times v ds,$$

using Stoke's theorem. We get the local relation

$$N(r) = \frac{1}{2\pi} \nabla \times v,$$

which gives the following continuity equation

$$\begin{aligned} \frac{\partial N}{\partial t} &= \frac{\partial}{\partial t} \sum_i N_i \delta(r - R_i) = \sum_i N_i \frac{\partial R_i}{\partial t} \frac{\partial}{\partial R_i} \delta(r - R_i) = - \sum_i N_i \frac{\partial R_i}{\partial t} \frac{\partial}{\partial r} \delta(r - R_i) \\ &= - \frac{\partial}{\partial r} \left(\sum_i N_i \frac{\partial R_i}{\partial t} \delta(r - R_i) \right) \equiv - \frac{\partial}{\partial r} J_v. \end{aligned}$$

A configuration with a single vortex at (x_0, y_0) can be written in the form

$$\phi(x, y) = n \arctan \left(\frac{y - y_0}{x - x_0} \right),$$

where n is the topological charge. Using this expression, we find that the energy of a single vortex of charge 1 in a circular system of radius R is

$$E = E_{core} + \int_{\xi}^R 2\pi r dr \kappa_0 \frac{(\nabla \phi)^2}{2} = E_{core} + \pi \kappa_0 \int_{\xi}^R \frac{dr}{r} = E_{core} + \pi \kappa_0 \log \left(\frac{R}{\xi} \right).$$

This expression diverges unless we add another vortex with an opposite charge at a distance $x_0 \gg \xi$, which results in

$$E_2 = 2\pi \kappa_0 \log \left(\frac{x_0}{\xi} \right) + const,$$

where $const \approx 2E_{core}$.

11.2 Kosterlitz-Thouless Argument

We now wish to show that despite the diverging energy of a single vortex, it can become stable due to entropic effects. As we will see below, the positional entropy provides a diverging contribution to the free energy, which competes with the energy found above.

The probability of creating a single vortex (at some fixed position) is

$$p_1 \sim e^{-H_1/T} = \exp\left(\frac{-\pi\kappa_0}{T} \log \frac{R}{\xi} + \frac{E_c}{T}\right) = e^{-E_c/T} \left(\frac{R}{\xi}\right)^{-\pi\kappa_0/T}$$

We have $(R/\xi)^2$ possible locations to place the core, giving us the probability

$$P = \left(\frac{R}{\xi}\right)^2 e^{-E_c/T} \left(\frac{R}{\xi}\right)^{-\pi\kappa_0/T} = e^{-E_c/T} \left(\frac{R}{\xi}\right)^{2-\pi\kappa_0/T}.$$

Thus if

$$2 - \frac{\pi\kappa_0}{T} > 0 \Rightarrow T > \frac{\pi\kappa_0}{2} \equiv T_{KT},$$

it becomes preferable to create vortices. Below T_{KT} isolated vortices are unstable. We saw that at low temperatures (in which case vortices were ignored)

$$\langle \psi^*(r)\psi(0) \rangle = |\psi_0|^2 \left(\frac{1}{r}\right)^\eta, \eta = \frac{T}{2\pi\kappa_0},$$

hence if $T < T_{KT} \Rightarrow \eta < 1/4$, and exactly at T_{KT} we get $\eta = 1/4$.

The argument we gave here is equivalent to the competition described above between the energy and the entropy of a single vortex. The free energy of the vortex is:

$$F = E - TS = \pi\kappa_0 \log\left(\frac{R}{\xi}\right) - 2T \log\left(\frac{R}{\xi}\right).$$

If the temperature is low enough, the energy “wins”, and F is positive \implies vortices are not created. If the temperature is above T_{KT} the entropy term wins, F becomes negative, and vortices proliferate. We expect a phase transition at $T_{KT} = \pi\kappa_0$. Below T_{KT} we will have vortices bound in pairs, and above T_c we will have free vortices – a plasma of vortices.

11.3 Describing vortices as a Coulomb gas

We will show now how this vortex plasma is mapped onto a 2D Coulomb gas, with logarithmic interactions. In the absence of a magnetic field the total vorticity is zero hence the topological charges obey

$$\sum N_i = 0.$$

We take the velocity field defined above and divide it into a rotational and irrotational part

$$\vec{V} = \vec{V}_0 + \vec{V}_1, \quad \nabla \times \vec{V}_1 = 0, \quad \nabla \cdot \vec{V}_0 = 0$$

$$N(r) = \frac{\nabla \times V}{2\pi} \Rightarrow \nabla \times \vec{V}_0 = 2\pi N(r)$$

From which we have

$$\int \vec{V}_1 \cdot \vec{V}_0 d^2r = \int (\nabla \cdot \phi) \cdot \vec{V}_0 d^2r = \int \nabla \cdot (\phi \vec{V}_0) d^2r = \oint \phi \vec{V}_{0\perp} dl = 0.$$

Defining

$$H = H_{vortex} + H_{SW}$$

$$H_{vortex} = \frac{\kappa_0}{2} \int |V_0|^2 d^2r + \text{core energies}$$

$$H_{SW} = \frac{\kappa_0}{2} \int |V_1|^2 d^2r$$

And defining an analog of the electric field of the form

$$\vec{E} = -2\pi\kappa_0 \hat{z} \times \vec{V}_0$$

we obtain

$$\nabla \cdot \vec{V}_0 = 0 \Rightarrow \nabla \times \vec{E} = 0$$

$$\vec{V}_{0\perp} = 0 \Rightarrow \vec{E}_{\parallel} = 0$$

$$\nabla \times \vec{V}_0 = 2\pi N(r) \Rightarrow \nabla \cdot \vec{E} = \frac{4\pi N(r)}{\varepsilon_0}, \varepsilon_0 = \frac{1}{\pi\kappa_0}$$

$$H_{vortex} = \frac{1}{8\pi\varepsilon_0} \int |E|^2 d^2r + \text{core} = \frac{1}{2\varepsilon_0} \sum_{ij} N_i N_j G(\vec{R}_i, \vec{R}_j) + \sum N_i^2 E_c$$

where the last equality is from previous lectures (or by analogy to the electrostatic problem). The effective interaction is similar to the 2D Coulomb interaction

$$G(\vec{R}_i, \vec{R}_j) = -2 \log \left(\frac{|\vec{R}_i - \vec{R}_j|}{\xi} \right).$$

11.3.1 RG Approach

We expect that when we apply coarse graining, the dielectric constant of the medium will change due to screening by intermediate vortex pairs which act as effective dipoles between any given vortex pair. We can define a new dielectric constant

$$\varepsilon_R = \varepsilon_0 + 4\pi\chi$$

$$\varepsilon_R = \begin{cases} \text{finite} & T < T_C \\ \infty & T > T_C \end{cases}$$

here T_C is the temperature that signals the onset of vortex proliferation (Note that vortices still exist at lower temperatures due to fluctuations despite the fact that they are not energetically favorable).

$$\varepsilon = \varepsilon_\xi + 4\pi \int \underbrace{P}_{\text{polarizability}} \underbrace{2\pi r}_{\text{probability to have a pair at distance } r} \underbrace{p(r)}_{\text{probability to have a pair at distance } r} dr$$

using the form $E_2(r) = 2E_c + 2\pi\kappa_0 \log \frac{r}{\xi}$, describing the energy of a dipole, we get

$$p(r) \sim e^{-E_2(r)/T} = \exp\left(-\left(2E_c + 2\pi\kappa_0 \log \frac{r}{\xi}\right)/T\right).$$

We assume that the gas is dilute enough such that the probability to have more than one pair is negligible. Thus this treatment only holds for $T < T_c$ or near T_c . Rewriting this, we get

$$p(r) = \frac{1}{\xi^4} y_0^2 \left(\frac{\xi}{r}\right)^{2\pi\kappa_0/T},$$

where $y_0 = e^{-E_c/T}$ is called the fugacity, and is assumed to be small. The factor $1/\xi^4$ is there from dimensional considerations, as this probability distribution is integrated with a measure of dimension x^4 .

The polarizability is related to the potential by

$$V = -\vec{P} \cdot \vec{E} = -pE \cos \theta = -qrE \cos \theta$$

$$P = qr \overline{\cos \theta} = qr \frac{\int e^{-V/kT} \cos \theta d\theta}{\int e^{-V/kT} d\theta} = qr \frac{\int e^{qrE \cos \theta/kT} \cos \theta d\theta}{\int e^{qrE \cos \theta/kT} d\theta} \underset{a=\frac{E}{kT}}{=} \frac{d}{da} \log \left(\int e^{qra \cos \theta} d\theta \right) \underset{a \ll 1}{\approx} \frac{(qr)^2}{2} a,$$

assuming $q = 1$ we find:

$$P = \frac{r^2}{2T},$$

which gives

$$\varepsilon = \varepsilon_\xi + 4\pi \int_{\xi}^{\infty} \frac{r^2}{2T} \frac{(2\pi r)}{\xi^4} y_0^2 \left(\frac{\xi}{r}\right)^{2\pi\kappa_0/T} dr = \varepsilon_\xi + \frac{4\pi^2}{T} y_\xi^2 \int_{\xi}^{\infty} \left(\frac{r}{\xi}\right)^{3-2/\varepsilon T} d\left(\frac{r}{\xi}\right)$$

We now want to apply coarse graining, i.e., integrate over small distances:

$$= \varepsilon_\xi + \frac{4\pi^2}{T} y_\xi^2 \underbrace{\int_{\xi}^{\xi(1+dl)} \left(\frac{r}{\xi}\right)^{3-2/\varepsilon T} d\left(\frac{r}{\xi}\right)}_{\equiv \varepsilon_{\xi'}} + \frac{4\pi^2}{T} y_\xi^2 \int_{\xi(1+dl)}^{\infty} \left(\frac{r}{\xi}\right)^{3-2/\varepsilon T} d\left(\frac{r}{\xi}\right)$$

where $\xi' \equiv \xi(1+dl)$

$$\begin{aligned} &= \varepsilon_{\xi'} + \frac{4\pi^2}{T} y_\xi^2 \underbrace{\left(\frac{\xi'}{\xi}\right)^{4-2/\varepsilon T}}_{\equiv y_{\xi'}^2} \int_{\xi'}^{\infty} \left(\frac{r}{\xi'}\right)^{3-2/\varepsilon T} d\left(\frac{r}{\xi'}\right) \\ &= \varepsilon_{\xi'} + \frac{4\pi^2}{T} y_{\xi'}^2 \int_{\xi'}^{\infty} \left(\frac{r}{\xi'}\right)^{3-2/\varepsilon T} d\left(\frac{r}{\xi'}\right) \end{aligned}$$

from the equation defining $\varepsilon_{\xi'}$,

$$\varepsilon_{\xi'} = \varepsilon_{\xi} + y_{\xi}^2 \frac{4\pi^2}{T} dl,$$

and the fact that dl is small, we get

$$\frac{d\varepsilon}{dl} = \frac{4\pi^2}{T} y^2.$$

By definition

$$\xi' \equiv \xi(1 + dl) \Rightarrow \frac{d\xi}{\xi} = dl \Rightarrow \xi(l) = \xi_0 e^l.$$

The coarse-grained fugacity takes the form

$$y_{\xi'}^2 = y_{\xi}^2 + y_{\xi}^2 \left(2 - \frac{2}{\varepsilon T}\right) dl$$

$$\frac{dy^2}{dl} = y^2 \left(4 - \frac{2}{\varepsilon T}\right)$$

Defining

$$\kappa = \frac{1}{\varepsilon T \pi}$$

$$\frac{dy}{dl} = (2 - \kappa\pi) y + O(y^3)$$

$$\frac{d\kappa^{-1}}{dl} = 4\pi y^2 + O(y^4)$$

and for $\kappa\pi < 2$ y increases while for $\kappa\pi > 2$ it decreases.

$$x = \frac{2}{\kappa\pi} - 1$$

$$d\kappa^{-1} = \frac{\pi}{2} dx$$

$$\frac{\pi}{2} dx = 4\pi^3 y^2$$

$$\kappa \approx \frac{2}{\pi} (1 - x)$$

$$\frac{\pi}{2} dx = 4$$

$$\frac{dy}{dl} = 2xy, \quad \frac{dx}{dl} = 8\pi^2 y^2$$

$$\frac{d^2x}{dl} = (4\pi y)^2, \quad \frac{d(4\pi y)}{dl} = 2x(4\pi y)$$

with $\tilde{x} = 2x$ and $\tilde{y} = 4\pi y$ we have

$$\frac{d\tilde{x}}{dl} = \tilde{y}^2, \quad \frac{d\tilde{y}}{dl} = \tilde{x}\tilde{y} \quad (145)$$

These are the KT RG flow equations.

We can define a constant of the motion by multiplying the first equation by \tilde{x} , the second by \tilde{y} and subtracting

$$\frac{d(\tilde{x}^2 - \tilde{y}^2)}{dl} = 0 \implies \tilde{x}^2 - \tilde{y}^2 = \text{const.}$$

We remove the tildes from now on. Along the line $x = -y$

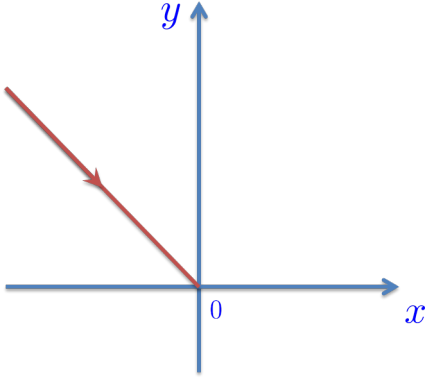

$$\frac{dy}{dl} = -y^2$$

$$-\frac{dy}{y^2} = dl \implies \frac{1}{y_\xi} - \frac{1}{y_0} = l = \log\left(\frac{\xi}{\xi_0}\right)$$

$$y_\xi = \frac{y_0}{1 + y_0 l} \approx \frac{1}{l}$$

$$y = -x = -\frac{1}{\log\left(\frac{\xi}{\xi_0}\right)}$$

at $T = T_C$ we have $x = 0 \implies \kappa = \frac{\kappa_R}{T_c} = \frac{2}{\pi}$, $\varepsilon_R = \frac{1}{2T_C}$ where ε_R is the dielectric constant at T_C .

The probability to find a pair at a distance r from one another at T_C is

$$P(r) = \frac{y^2}{r^4} = \frac{1}{r^4 \log^2(r/\xi_0)}$$

We now look at other regions of the phase diagram.

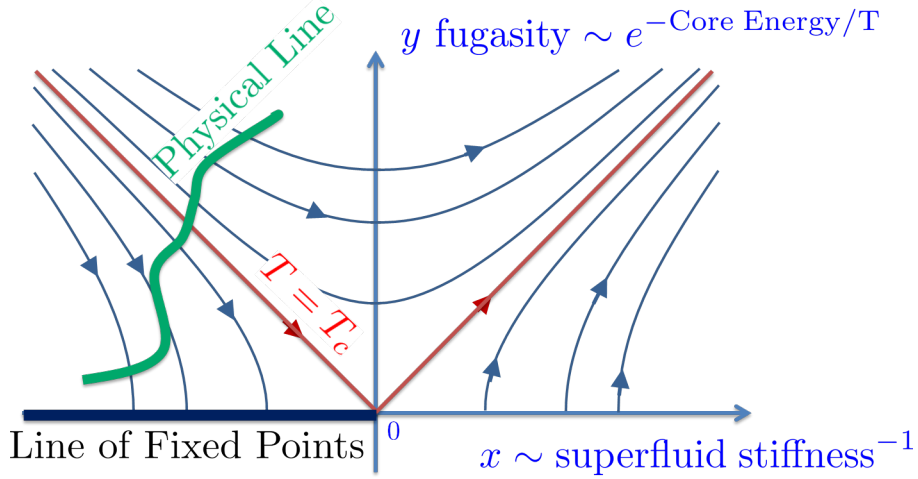

For $T < T_C$, near $y = 0$

$$x^2 - y^2 = (T - T_C) b^2$$

we can assume a linear dependence because $x^2 - y^2$ changes sign when we change the relative sizes of T and T_C

$$x = b\sqrt{T_C - T}$$

$$\frac{\kappa_R}{T_C} = \frac{2}{\pi} + b\sqrt{T_C - T}$$

This derivation breaks down in the area of positive x where y grows. This is because it was based on the assumption that the fugacity is small and the pair density is low.

For $T > T_C$

$$y^2 = x^2 + b^2 (T - T_C)$$

$$\frac{dx}{dl} = x^2 + b^2 (T - T_C)$$

$$\int_{\xi_0}^{\xi} dl = \int_{x_0}^1 \frac{dx}{x^2 + b^2 (T - T_C)}$$

where we take $x = 1$ because at scales of order 1, our RG treatment breaks down

$$l = \frac{1}{b\sqrt{T - T_C}} \tan^{-1} \left(\frac{x}{b\sqrt{T - T_C}} \right) \Big|_{x_0}^1 \approx \frac{1}{b\sqrt{T - T_C}}$$

From this we can extract a length. We identify this temperature dependent length scale as the screening length

$$\xi_+ = r_{sc} = \xi_0 e^{1/b\sqrt{T - T_C}}$$

If we want to discover how many vortices we have, we can calculate the effective screening radius of a certain vortex concentration and compare to the one we found. According to Debye

$$\frac{4\pi n_{\text{free}}}{T\varepsilon} = 8\pi n_{\text{free}}$$

from which

$$n_{\text{free}} = \frac{1}{\xi_+^2}$$

11.3.2 The order of the KTB phase transition

Which thermodynamic quantity changes in this phase transition?

$$H_{NU} = \int [\alpha\psi^2 + \beta\psi^4 + J(\nabla\psi)^2] d^d r$$

and a saddle point approximation gives $\psi^2 = \frac{\alpha}{2\beta}$. Assuming the derivative terms are of the same scale as the potential terms

$$\frac{J}{\xi^2} \sim \alpha$$

$$\frac{1}{2} \int J(\nabla\psi)^2 d^d r \sim J\xi^{d-2} |\psi|^2 = \frac{J\xi^{d-2}\alpha}{2\beta} = \frac{J^2}{2\beta}\xi^{d-4}.$$

For $d = 2$ we have

$$H_{NU} \propto \frac{1}{\xi^2}$$

$$F_{\text{singular}} \sim \frac{1}{\xi^2}$$

thus

$$\frac{\partial^n F}{\partial T^n} = \frac{b}{(T - T_C)^{n+1/2}} e^{-2/b\sqrt{T-T_C}}$$

meaning the transition is continuous at any order.

The superfluid density however changes discontinuously.

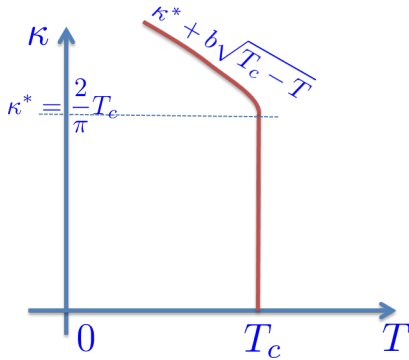

Due to the presence of vortices above the transition, the 2 point function changes its behavior as well:

$$\langle \psi(r)\psi(0) \rangle = \begin{cases} T > T_C & e^{-r/\xi_+} \\ T < T_C & (1/r)^{T/2\pi\kappa} \end{cases}$$

11.4 Coulomb gas and the Sine-Gordon mapping (Momentum RG)

11.4.1 Mapping between Coulomb Gas and the Sine Gordon model

$$S_V = \frac{1}{T} \left[\frac{1}{2\varepsilon_0} \sum_{ij} N_i N_j G \left(\left| \vec{R}_i - \vec{R}_j \right| / \xi \right) + \sum N_i^2 E_c \right]$$

$$G(x) = -2 \log(x)$$

$$z = \sum_{N_i=0,\pm 1} \exp(-S_V)$$

where we drop vortices with charge larger than 1. Using the general formula for a Gaussian integral

$$\int \frac{dx_1 \dots dx_n}{(2\pi)^{n/2}} \exp \left(-\frac{1}{2} x_i A_{ij} x_j + x_i J_i \right) = (\det A)^{-1/2} \exp \left(\frac{1}{2} J_i A_{ij}^{-1} J_j \right)$$

$$\exp \left(-\frac{1}{2\varepsilon_0} N_i N_j V_{ij} \right) = \det \left(\frac{V^{-1}}{2\varepsilon} \right)^{1/2} \frac{1}{(2\pi)^{1/2}} \int d\varphi_1 \dots d\varphi_n \exp \left(-\frac{1}{2} \varphi_i V_{ij}^{-1} \varphi_j + i\varphi_i N_i \right)$$

and adding the core energy term

$$\begin{aligned} z &= N \int \mathcal{D}\varphi(x) \exp \left(-\frac{1}{2} \sum_{i \neq j} \varphi(x_i) V^{-1}(x_i - y_i) \varphi(y_i) 2\varepsilon_0 T \right) \prod_i \sum_{N_i=0,\pm 1, \dots} \exp(i\varphi_i N_i + N_i^2 E_c / T) \\ &\approx N \int \mathcal{D}\varphi(x) \exp \left(-\frac{1}{2} \sum_{i \neq j} \varphi(x_i) V^{-1}(x_i - y_i) \varphi(y_i) 2\varepsilon_0 T \right) \prod_i (1 + 2(\cos \varphi_i) \exp(-E_c / T)) \\ &\approx N \int \mathcal{D}\varphi(x) \exp \left(-\frac{1}{2} \sum_{i \neq j} \varphi(x_i) V^{-1}(x_i - y_i) \varphi(y_i) 2\varepsilon_0 T \right) \exp \left(-y \sum 2(\cos \varphi_i) \right) \end{aligned}$$

$$V(q) = \frac{1}{q^2} \Rightarrow V^{-1}(q) = q^2 \Rightarrow V(x) = \delta(x) \nabla^2$$

$$= N \int \mathcal{D}\varphi(x) \exp \left(-\frac{1}{2} \int (\nabla \varphi(x))^2 d^2 x 2\varepsilon_0 T + \frac{2y}{a^2} \int d^2 x \cos \varphi(x) \right)$$

changing variables to $\sqrt{2\varepsilon_0 T} \varphi, \beta = \frac{1}{\sqrt{2\varepsilon_0 T}}, M = 2y_0 = 2e^{-E_c/T}$

$$= N \int \mathcal{D}\varphi(x) \exp \left(-\frac{1}{2} \int \underbrace{(\nabla \varphi)^2 d^2 x}_{S_0} + \underbrace{M \int d^2 x \cos(\beta \varphi)}_{S_1} \right)$$

11.4.2 (Momentum shell) Renormalization group of the sine Gordon Model

[Here we follow with some additional details chapter 10 of Ref. [6]]

We split a high momentum shell from the system ($b > 1$)

$$\varphi_\Lambda(x) = \frac{1}{\sqrt{V}} \left(\underbrace{\sum_{K < \frac{\Lambda}{b}} e^{ikx} \varphi_K}_{\varphi_S(x)} + \underbrace{\sum_{\frac{\Lambda}{b} < K < \Lambda} e^{ikx} \varphi_K}_{\varphi_F(x)} \right)$$

and since S_0 is diagonal in momentum space,

$$\begin{aligned} z_\Lambda &= \int \mathcal{D}\varphi_S \mathcal{D}\varphi_F e^{-S_0[\varphi_S] - S_0[\varphi_F] - S_1[\varphi_F + \varphi_S]} \\ &= \int \mathcal{D}\varphi_F e^{-S_0[\varphi_F]} \int \mathcal{D}\varphi_S e^{-S_0[\varphi_S]} \frac{\int \mathcal{D}\varphi_F e^{-S_0[\varphi_F] - S_1[\varphi_F + \varphi_S]}}{\int \mathcal{D}\varphi_F e^{-S_0[\varphi_F]}} \\ &= z_F \int \mathcal{D}\varphi_S e^{-S_0[\varphi_S]} \left\langle e^{-S_1[\varphi_F + \varphi_S]} \right\rangle_F \end{aligned}$$

giving an effective action for the slow degrees of freedom:

$$S_{\text{eff}}(\varphi_S) = S_0(\varphi_S) - \log \left\langle e^{-S_1[\varphi_F + \varphi_S]} \right\rangle_F.$$

The basic idea here is to average over the fast degree of freedom a φ_f and obtain an effective action in terms of the slow variables φ_s . The parameters of the action S are renormalized and the RG procedure is established.

We assume the core energy is small, hence M is small. Thus using the cumulant expansion $\log \langle 1 - S_1 + \frac{1}{2} S_1^2 \rangle = \langle S_1 \rangle - \frac{1}{2} \langle S_1^2 \rangle + \frac{1}{2} \langle S_1 \rangle^2$, we get

$$S_{\text{eff}}(\varphi_S) = S_0(\varphi_S) - \langle S_1(\varphi_F + \varphi_S) \rangle + \frac{1}{2} \langle S_1^2(\varphi_F + \varphi_S) \rangle - \frac{1}{2} \langle S_1(\varphi_F + \varphi_S) \rangle^2$$

11.4.2.1 First order term

11.4.2.1.1 Integrating out the fast variables – thinning the degrees of freedom The first order term is

$$\begin{aligned} \langle S_1(\varphi_F + \varphi_S) \rangle &= \frac{M}{a^2} \int d^2x \langle \cos(\beta(\varphi_S + \varphi_F)) \rangle_F \\ &= \frac{1}{2} \frac{M}{a^2} \int d^2x \sum_{\sigma=\pm 1} e^{i\beta\sigma\varphi_S} \langle e^{i\beta\sigma\varphi_F} \rangle_F \\ \langle e^{i\beta\sigma\varphi_F} \rangle_F &= e^{-\frac{1}{2}\beta^2 \langle \varphi_F^2 \rangle} \equiv e^{-\frac{1}{2}\beta^2 G(0)} \equiv A(0) \end{aligned}$$

$$G(0) = \langle \varphi_F(0) \varphi_F(0) \rangle = \frac{1}{(2\pi)^2} \int_{\Lambda-d\Lambda=\Lambda/b}^{\Lambda} d^2k \frac{1}{k^2} = \frac{1}{2\pi} \int \frac{dk}{k} = \frac{1}{2\pi} d \log \Lambda \equiv \frac{1}{2\pi} dl$$

$$A(0) = e^{-\frac{1}{2}\beta^2\langle\varphi_F^2\rangle} = 1 - \frac{\beta^2}{4\pi}dl$$

Thus to first order

$$S_{\text{eff}}(\varphi_S) = \frac{1}{2} \int (\nabla\varphi_S)^2 d^2x + M \left(1 - \frac{\beta^2}{4\pi}dl\right) \int \frac{d^2x}{a^2} \cos(\beta\varphi_S)$$

11.4.2.1.2 Rescaling We apply

$$x' = x/b \Rightarrow q' = bq$$

where $b = \frac{1}{1-dl}$

which doesn't change S_0

$$S_{\text{eff}}(\varphi_S) = \frac{1}{2} \int (\nabla\varphi_S)^2 d^2x' + M \left(1 + \left(2 - \underbrace{\frac{\beta^2}{4\pi}}_{\text{dim}}\right)dl\right) \int \frac{d^2x'}{a^2} \cos(\beta\varphi_S)$$

$$M' = M(1 + (2 - \text{dim})dl)$$

$$M' - M = \frac{dM}{dl} = (2 - \text{dim})M$$

$$M(L) = M_0 \left(\frac{L}{a}\right)^{2-\text{dim}}$$

M_0 represents the fugacity. We can see that for $\text{dim} < 2$ the coefficient M grows and our approximation breaks. This allows us to obtain a scale which is an effective screening length, since beyond it there are many vortices and our treatment breaks down.

$$1 = M_0 \left(\frac{\xi_{\pm}}{a}\right)^{2-\text{dim}} \Rightarrow \xi_{\pm} = \left(\frac{1}{M_0}\right)^{1/(2-\text{dim})} a.$$

It is useful to remember that an operator with a large dimension is irrelevant in the renormalization group sense

11.4.2.1.3 Field rescaling We neglected the fact that φ_S also depends on x when we changed variables to x' . We can show that to first order this is trivial

$$\varphi(x) = \bar{\zeta}\varphi_S(x')$$

$$\varphi_q = \zeta\varphi_{q'}$$

we choose $\bar{\zeta} = 1$ to keep S_0 invariant. This means

$$\varphi_q = \int d^2x e^{iqx} \varphi_S(x) = b^2 \int d^2x' \varphi_S(x') e^{iq'x'} = b^2 \varphi_{q'}$$

giving

$$\zeta = b^2$$

11.4.2.2 Second order term

11.4.2.2.1 Integrating out the fast variables We now consider the $O(M^2)$ terms in the cumulant expansion of $S_{\text{eff}}(\varphi_S)$:

$$\begin{aligned} 2O(M^2) &= \langle S_1^2(\varphi_F + \varphi_S) \rangle - \langle S_1(\varphi_F + \varphi_S) \rangle^2 \\ &= M^2 \int d^2x_a d^2x_b \langle \cos(\beta(\varphi_F^a + \varphi_S^a)) \cos(\beta(\varphi_F^b + \varphi_S^b)) \rangle - \langle \cos(\beta(\varphi_F^a + \varphi_S^a)) \rangle \langle \cos(\beta(\varphi_F^b + \varphi_S^b)) \rangle \\ &= \frac{M^2}{4} \int d^2x_a d^2x_b \sum_{\sigma_a, \sigma_b = \pm 1} \left(\langle e^{i\sigma_a \beta \varphi_F^a} e^{i\sigma_b \beta \varphi_F^b} \rangle - \langle e^{i\sigma_a \beta \varphi_F^a} \rangle \langle e^{i\sigma_b \beta \varphi_F^b} \rangle \right) e^{i\sigma_a \beta \varphi_S^a} e^{i\sigma_b \beta \varphi_S^b}. \end{aligned}$$

The sum over $\sigma_a, \sigma_b = \pm$ gives four terms. The one with $\sigma_a = \sigma_b = 1$ (whose integrand we denote by Y_1) is given by

$$\frac{M^2}{4} \int d^2x_a d^2x_b \left(\langle e^{i\beta \varphi_F^a} e^{i\beta \varphi_F^b} \rangle - \langle e^{i\beta \varphi_F^a} \rangle \langle e^{i\beta \varphi_F^b} \rangle \right) e^{i\beta \varphi_S^a} e^{i\beta \varphi_S^b} \equiv \frac{M^2}{4} \int d^2x_a d^2x_b Y_1 e^{i\beta \varphi_S^a} e^{i\beta \varphi_S^b}.$$

Since the free part of the action is quadratic we have $\langle e^{\pm i\beta \varphi_F^a} \rangle = 1 \pm \langle i\beta \varphi_F^a \rangle - \frac{\beta^2}{2} \langle \varphi_F^{a2} \rangle + \dots = 1 - \frac{\beta^2}{2} \langle \varphi_F^{a2} \rangle = e^{-\frac{\beta^2}{2} \langle \varphi_F^{a2} \rangle}$. (An alternative way to prove this identity is to complete to a square and perform the Gaussian integration.) Using this identity we find:

$$\begin{aligned} Y_1 &= e^{-\frac{\beta^2}{2} \langle (\varphi_F^a + \varphi_F^b)^2 \rangle} - e^{-\frac{\beta^2}{2} \langle \varphi_F^{a2} \rangle} e^{-\frac{\beta^2}{2} \langle \varphi_F^{b2} \rangle} = e^{-\beta^2 \langle \varphi_F^{a2} \rangle} \left(e^{-\beta^2 \langle \varphi_F^a \varphi_F^b \rangle} - 1 \right) \\ &\equiv e^{-\beta^2 G(0)} \left(e^{-\beta^2 G(x_a - x_b)} - 1 \right) \equiv A^2(0) (A^2(x_a - x_b) - 1). \end{aligned}$$

Averaging over the free field action S_0 give the following expression for the function G :

$$G(x_a - x_b) = \int_{\Lambda/b}^{\Lambda} \frac{e^{ip(x_a - x_b)}}{(2\pi)^2 p^2} d^2p.$$

A similar term $Y_2 = Y_1$ when taking $\sigma_a = \sigma_b = -1$ and two other terms where the sign in the first exponent is flipped, giving

$$O(M^2) = \frac{M^2}{4} \int d^2x_a d^2x_b \left[A^2(0) (A^2(x_a - x_b) - 1) \cos(\beta(\varphi_S^a + \varphi_S^b)) + A^2(0) \left(\frac{1}{A^2(x_a - x_b)} - 1 \right) \cos(\beta(\varphi_S^a - \varphi_S^b)) \right].$$

For $x \gg \frac{b}{\Lambda}$ the oscillations in $G(x) \propto \int_{\Lambda/b}^{\Lambda} \frac{e^{ipx}}{p^2} dp$ lead to $G(x) \approx 0 \Rightarrow A^2(x) \approx 1$, and thus $A^2(x) \neq 1$ only for small $x < b/\Lambda$.

Hence x_a is very close to x_b . Setting $x_a = x_b$ the first term contains $\cos(2\beta\varphi_S^a)$ which is a vortex of charge 2 made by two overlapping charge 1 vortices - even though we didn't include such vortices in our partition function. In such situations we say that the RG procedure generated a new term. For parameters near the KTB transition (large

The second will act like a derivative.

Defining $z = \frac{x_a + x_b}{2}$, $\xi = x_a - x_b$, around $x_a = x_b$

$$O(M^2) = \frac{M^2}{2} \int d^2z d^2\xi \left[A^2(0) (A^2(\xi) - 1) \cos(2\beta\varphi_S(z)) + A^2(0) \left(\frac{1}{A^2(\xi)} - 1 \right) \cos(\xi\beta\partial_z\varphi_S(z)) \right].$$

and since ξ is very small we can use the approximation $\cos(\xi\beta\partial_z\varphi_S(z)) \approx 1 - \frac{1}{2}(\xi\beta\partial_z\varphi_S(z))^2$ to find:

$$O(M^2) = \frac{M^2}{2} \int d^2z \left[a_1 \cos(2\beta\varphi_S(z)) + a_3 - \frac{a_2\beta^2}{2} (\nabla\varphi_S)^2 \right],$$

where

$$a_1 = \int d^2\xi A^2(0) (A^2(\xi) - 1), a_2 = \int d^2\xi \xi^2 A^2(0) \left(\frac{1}{A^2(\xi)} - 1 \right), a_3 = \int d^2\xi A^2(0) \left(\frac{1}{A^2(\xi)} - 1 \right).$$

In addition

$$G(\xi) = \frac{1}{(2\pi)^2} \int_{\Lambda/b}^{\Lambda} \frac{e^{ip\xi\cos\theta}}{p^2} p dp d\theta = \frac{1}{2\pi} J_0(\xi\Lambda) \frac{d\Lambda}{\Lambda}$$

where J_0 is a Bessel function. It features oscillations which are due to the fact that we used a sharp cutoff. Expanding the exponent in Λ ,

$$a_2 \approx \beta^2 \frac{1}{2\pi} \int d^2\xi J_0(\xi\Lambda) \underbrace{\frac{d\Lambda}{\Lambda}}_{dC} \equiv \beta^2 dC$$

where C is a number. Carefully examining the last integral we see that it does not converge, it can be shown (we do not show it here) that when the sharp cutoff is replaced by a soft one, the expression for C converges. This gives

$$O(M^2) = \frac{1}{2} M^2 \beta^4 (2C) dl (\nabla\varphi_S)^2.$$

Gathering terms of order M as well we write:

$$S_{\text{eff}} = \frac{1}{2} \int d^2x \left[(1 + M^2 \beta^4 2C dl) (\nabla\varphi_S)^2 + M \left(1 - \frac{\beta^2}{4\pi} dl \right) \cos(\beta\varphi_S) + a_1 M^2 \cos(2\beta\varphi_S) + a_3 \right]$$

where the term $\propto a_2$ is irrelevant in the RG sense, and the term a_3 is a normalization constant. The normalization constant is not important as it will drop off in all the Gaussian averaging procedures.

11.4.2.2.2 Rescaling Rescaling the space x as in sub paragraph 11.4.2.1.2 we obtain the equation:

$$M' = M \left(1 - \left(\underbrace{2}_{\text{from rescaling of } x} - \frac{\beta^2}{4\pi} \right) dl \right)$$

11.4.2.2.3 Field Rescaling Unlike the first order case the field rescaling here is not trivial. Defining

$$\varphi_{\text{new}} = \sqrt{1 + M^2 \beta^4 2C dl} \varphi_S \approx (1 + M^2 \beta^4 C dl) \varphi_S$$

$$\beta' = \beta (1 - M^2 \beta^4 C dl)$$

So that eventually

$$S_{\text{eff}} = N' \int \mathcal{D}\varphi(x) \exp \left(-\frac{1}{2} \int \underbrace{(\nabla\varphi)^2 d^2x}_{S_0} + M' \int \underbrace{d^2x \cos(\beta'\varphi)}_{S_1} \right)$$

To complete the RG equation near the KTB transition we define $\frac{\beta^2}{4\pi} = 2 - x$ which yield: $\frac{dM}{dl} = xM$; $\frac{d\beta}{dl} = M^2\beta^5 C$ defining now $y = \sqrt{(8\pi)^2 CM}$ we get the RG equations which are similar to the one in the real space approach in Eq. (145)

$$\frac{dy}{dl} = -xy, \frac{dx}{dl} = -y^2. \quad (146)$$

The sign changed compared to the former renormalization is because now we go to smaller momenta vs. longer lengths.

12 The Quantum Hall Effect – This chapter is still under construction

A nice review of the quantum Hall Effect is given in [5] it includes discussions of Graphene as well.

12.1 Classical Hall Effect

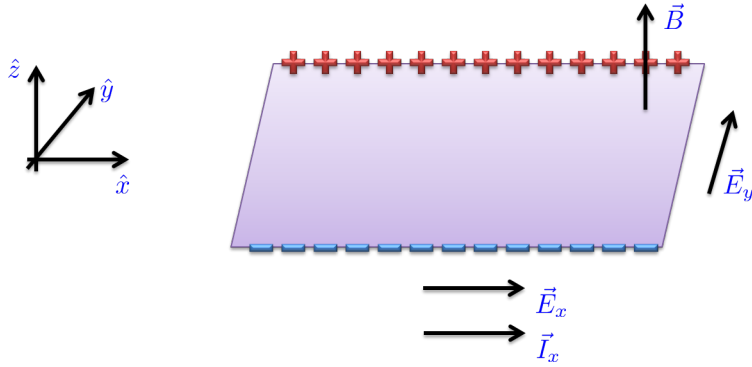

Figure 15: The Hall effect in classical system, current is driven in the x direction and in the presence of magnetic field the Lorentz force pushes electrons to the boundaries of the sample. This process continues until the electric field due to the electrons accumulated at the boundaries cancels the Lorentz force

The classic Hall experiment is depicted in Fig. 15. In response to the electric Field E_x current J_x is flowing in the wire. In addition due to the magnetic field B in the \hat{z} direction a Lorentz force deflect the electrons. The deflected electrons are accumulated in the sample boundary and build up an electric field E_y that cancels the Lorentz force. Working in the convention $e = -|e|$ we find:

$$\frac{e}{c} \vec{v} \times \vec{B} = -eE_y.$$

Defining j in terms of the carrier density n as $j = env$ we find:

$$B \frac{env}{c} \times \hat{z} = -enE_y \quad \Rightarrow \quad \vec{E} = -\frac{B}{enc} \vec{J} \times \hat{z},$$

which gives

$$\frac{E_y}{J_x} \equiv R_B = \frac{-B}{enc}.$$

Hence, measuring the Hall voltage allows measuring the carrier density n and the sign of their charge. Notice that in the absence of impurities the current flows in a direction that is perpendicular to both the the electric and the magnetic field $\vec{J} \propto \vec{E} \times \vec{B}$.

If we add impurities, quantify their strength by the mean free collision time τ between them the EOM become:

$$m\dot{\vec{v}} = e\vec{E} + \frac{e}{c} \vec{v} \times \vec{B} - \frac{m\vec{v}}{\tau} \quad \Rightarrow \quad \vec{J} = \frac{ne^2}{m} \vec{E} + \frac{e}{cm} \vec{J} \times \vec{B} - \vec{J}/\tau.$$

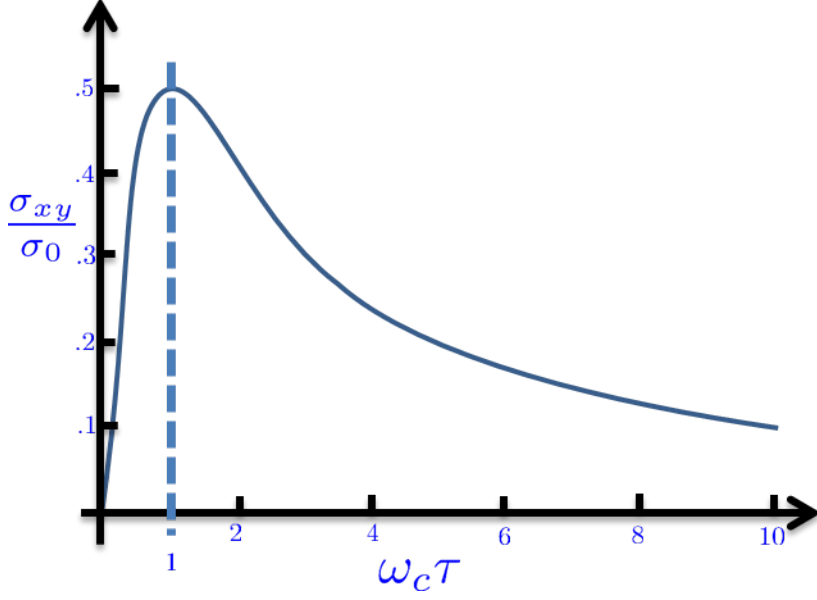

Figure 16: the Hall conductance σ_{xy} as a function of magnetic

We solve the equation in the frequency space, with (i) $\dot{\vec{J}} = i\omega\vec{J}$ and (ii) the matrix relation between \vec{J} and \vec{E}

$$\vec{E} = \begin{pmatrix} E_x \\ E_y \end{pmatrix} = \hat{\rho}\vec{J} = \begin{pmatrix} \rho_{xx} & \rho_{xy} \\ \rho_{yx} & \rho_{yy} \end{pmatrix} \begin{pmatrix} J_x \\ J_y \end{pmatrix}$$

we find:

$$\rho = \begin{pmatrix} \frac{m}{ne^2\tau}(1+i\omega\tau) & \frac{B}{nec} \\ -\frac{B}{nec} & \frac{m}{ne^2\tau}(1+i\omega\tau) \end{pmatrix}.$$

Using the matrix relation demand careful examination of the boundary conditions, for example assuming that we apply electric field $\vec{E} = E\hat{x}$ in the presence of magnetic field, $\vec{B} = B\hat{z}$ because current is not flowing in the y direction we will obtain $E_y = \rho_{xy}J_x$.

We can rearrange $\hat{\rho}$ in the form:

$$\hat{\rho} = \frac{1}{\sigma_0} \begin{pmatrix} 1+i\omega\tau & \omega_c\tau \\ -\omega_c\tau & 1+i\omega\tau \end{pmatrix},$$

where $\sigma_0 = \frac{ne^2\tau}{m}$, $\omega_c = \frac{eB}{mc}$. Inversion of the resistivity matrix to the conductivity we have:

$$\hat{\sigma}(\omega=0) = \frac{\sigma_0}{(1+(\omega_c\tau)^2)} \begin{pmatrix} 1 & \omega_c\tau \\ -\omega_c\tau & 1 \end{pmatrix} \xrightarrow{\omega_c\tau \gg 1} \begin{pmatrix} \frac{\sigma_0}{(\omega_c\tau)^2} & -\frac{nec}{B} \\ \frac{nec}{B} & \frac{\sigma_0}{(\omega_c\tau)^2} \end{pmatrix}. \quad (147)$$

We note that for large $\omega_c\tau$ (large B) both the resistivity (ρ_{xx} and ρ_{yy}) and conductivity (σ_{xx} and σ_{yy}) on the diagonal are negligible (with $\omega = 0$) with respect to the Hall terms.

This "wired" situation that both resistance and conductance are small is special to the motion of electrons in strong magnetic field. To understand qualitatively the origin of this behavior we note that the terms on the diagonal can be written as:

$$\frac{e^2n}{m} \left[\tau \frac{1}{(\omega_c\tau)^2} \right]$$

giving

$$\tau_{\text{eff}} = \frac{1}{\omega_c^2 \tau}$$

From dimensional considerations we can define a diffusion constant. $[D] = [lv] = v^2 \tau = l^2 / \tau$ with l typical step length in a random motion and τ the typical time between steps. And hence (since the electrons move typically in the Fermi velocity) we have

$$D = v_F^2 \tau_{\text{eff}} = \frac{(v_F \omega_c)^2}{\tau} = \frac{R_c^2}{\tau}.$$

In strong magnetic field the typical step is R_c the cyclotron radius and the typical time between "hopping between circles" is τ . We note the surprising fact that increasing the impurities and hence decreasing τ will actually increase the conductivity. This can be explained by the fact that without impurities the electrons will simply perform circular orbits. The scattering from the impurities will cause them to move in the direction of the external field.

12.2 Quantum Hall effect

The (Integer) Quantum Hall effect was discovered in 1980 by Klaus von Klitzing who measured the Hall resistance in a two-dimensional electron gas, realized with a silicon metal-oxide-semiconductor field-effect transistor. The Hall conductance was quantized of $e^2/h\nu$ with ν being an integer. Later, in 1982 Dan C. Tsui, Horst L. Stormer, and Art C. Gossard observed conductance quantization at a fractional values $\nu = 1/3$ more fraction were measured later on $\nu = 2/5, 3/7, 2/3, 3/5, 1/5, 2/9, 3/13, 5/2, 12/5 \dots$. The fractional values are observed originally and in most experiments later on heterostructure of Aluminium Gallium Arsenide/ Gallium Arsenide. In the boundary between the two materials a clean two dimensional electron gas is formed. Recently quantum and fractional Hall effect where also observed in Graphene.

7

Two Nobel prizes were awarded for the discoveries and the explanation of the Integer and fractional quantum Hall effect. The purpose of this chapter is to highlight the experimental finding and to show how we use topological arguments to explain the novel state of matter that give integer values for the Hall conductance.

The discussion here tries to exemplify the dialogue between theory and experiment. Experimental results give hints and clues for the state of the system then clever arguments lead to additional conclusions about the nature of the system, those are drawn even without having a microscopic theory.

12.2.1 Experimental observations

Fig. 17 depicts typical experimental observation of the quantum Hall effect, the main effects are:

1. Quantized values of the Hall resistance

The Hall resistance show plateaus at

$$\rho_{xy} = \frac{h}{e^2 \nu}, \nu \in N$$

With a stronger field there are also plateaus at fractional values

$$\nu = \frac{1}{3}, \frac{2}{5}, \frac{3}{4}, \dots$$

2. Effect of disorder

It was found experimentally that for cleaner samples we have more plateaus however that plateaus are narrower.

⁷Notice that in a square 2D sample of thickness d and linear dimension $L_x = L_y = L$ the resistance $R_{xx} = \rho \frac{L_x}{dL_y} = \frac{\rho}{d}$.

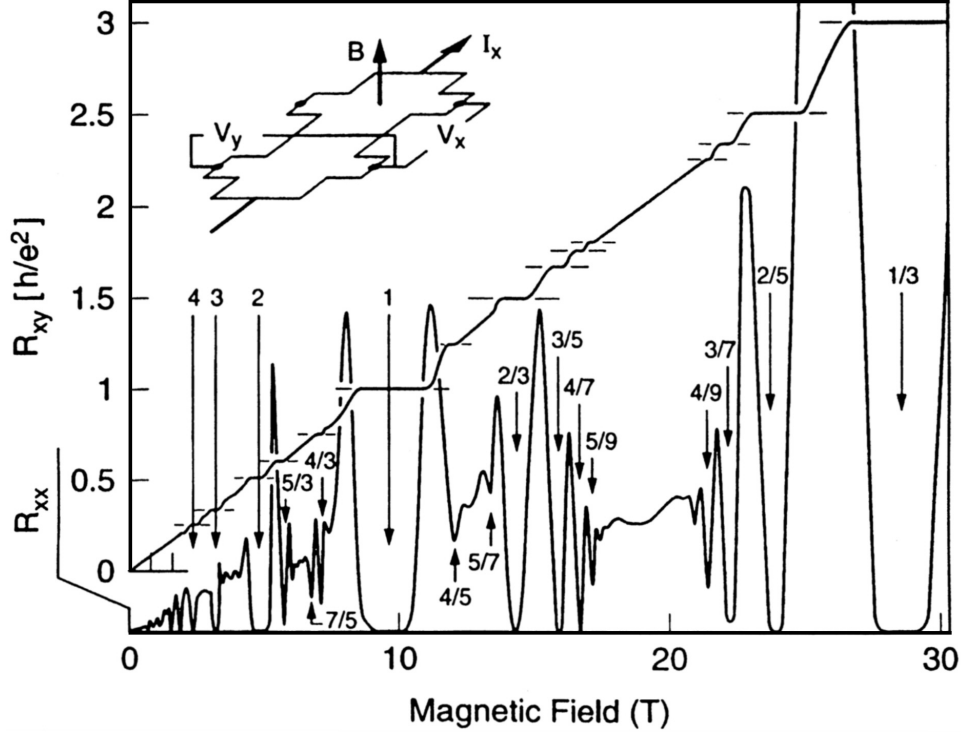

Figure 17: Here we plot the Hall resistance R_{xy} and the resistance R_{xx} . In the classical Hall effect R_{xx} is constant and R_{xy} depends linearly on the Magnetic field. As we see the experimental results are quite different, R_{xx} fluctuates with the magnetic field and is zero at integer and fractional filling factor.

3. Vanishing longitudinal resistance R_{xx}

As we can see in the Fig. 17 at small magnetic field there are small oscillations in the resistance these are known as the Shubnikov-deHaas oscillations, similar oscillations in the magnetization are deHaas van Alphen oscillations). At stronger magnetic field when plateaus are developed in the Hall resistance R_{xy} the longitudinal resistance R_{xx} is close to zero. Notice that due to the strong magnetic field, not surprisingly, the longitudinal conductance is also very small. The temperature dependence of the resistance is not shown in Fig. 17, but it was found that it increases exponentially with the temperature, i.e., $\sigma \sim e^{-T_0/T}$.

12.3 Basic explanation of the quantization effect

The Hamiltonian describing electrons moving in three dimensions in the presence of magnetic field is given in Landau's gauge by:

$$\hat{H} = \frac{-\hbar^2}{2m} \frac{\partial^2}{\partial y^2} + \frac{1}{2m} (\hbar k_x - eBy)^2 + eE_x x + U(x, y) + \frac{k_z^2}{2m} - \mu. \quad (148)$$

In finite width samples (in the z direction) electrons can not move in the z direction hence $k_z = \pi n_z / L_z$ is quantized. We will assume henceforth that only the first sub-band with $n_z = 1$ is occupied and absorb the energy $k_z^2 / 2m$ in the definition of μ . The potential $U(x, y)$ describes the effect of disorder – scattering of the electrons due to impurities. In principle, we should include also interaction effects between the electrons. Microscopically, these interactions are responsible for the formation of the fractional states.

The motion of the electrons in a strong electric field lead to the formation of Landau's levels. Taking periodic boundary conditions in the x direction, (having a Corbino geometry) we obtain a set of Landau levels as follows. First choose a convenient gauge $\psi(x, y) = e^{ik_x x} \phi(y)$ the Schrodinger equation become:

$$\hat{H}\psi(x, y) = e^{ik_x x} \left[\frac{1}{2m} (\hbar k_x - eyB)^2 + \frac{1}{2m} \partial_y^2 - \mu \right] \phi(y) \quad (149)$$

with the periodic boundary condition in the x direction we have $k_x = \frac{2\pi}{L} n_x$ with n_x an integer. Defining now:

$$y_{n_x} = \frac{2\pi\hbar}{Be} n_x = \frac{l_B^2}{L_x} n_x; \quad Bl_B^2 \equiv \frac{h}{e} = \Phi_0$$

we obtain

$$H\psi(x, y) = e^{ik_x x} \left[\frac{\hbar\omega_c}{2} (y - y_{n_x})^2 + \frac{1}{2m} \partial_y^2 - \mu \right] \phi(y) \quad (150)$$

hence the Landau levels with energy $E = \hbar\omega_c(n_{\text{Landau}} + 1/2)$ are centered around y_{n_x} .

From the requirement $0 < y_{n_x} < L_y$ we can find the degeneracy of each level:

$$0 < n_x < \frac{L_x L_y}{l_B^2} = \frac{L_x L_y B}{\Phi_0} = \frac{\Phi}{\Phi_0}.$$

Denoting N the total number of particle we can define also the filling factor:

$$\nu = \frac{\text{number of electrons}}{\text{degeneracy of LL}} = \frac{N}{\Phi/\Phi_0} = \frac{\Phi_0}{\Phi/N} = \frac{\text{flux quantum}}{\text{flux per electron}} = \frac{N\Phi_0}{\Phi} = \frac{N/(L_x L_y)\Phi_0}{\Phi/(L_x L_y)} = \frac{n\Phi_0}{B}.$$

For example for $\nu = 2$ we have exactly one flux quantum for two electrons, and the spin up and spin down levels of the first Landau's level (with $n_{\text{Landau}} = 0$) are filled. For $\nu = 1/3$ we have 3 quantum fluxes per electron.

Semiclassically, we expect that near the edge of the sample the parabola will be effectively narrower (as one side is blocked by the infinite potential of the sample edge) so that the energies of the Landau levels are higher near the edge.

Similarly we expect that smooth disorder (smooth on the scale of l_B) will tend to change the Landau level energies in the bulk of the sample. It can be shown (we do not explain it in details here) that states with energy at the center of the Landau level are delocalized through out the sample while those away from the center are localized. These qualitative explanations are summarized in the Fig. 19.

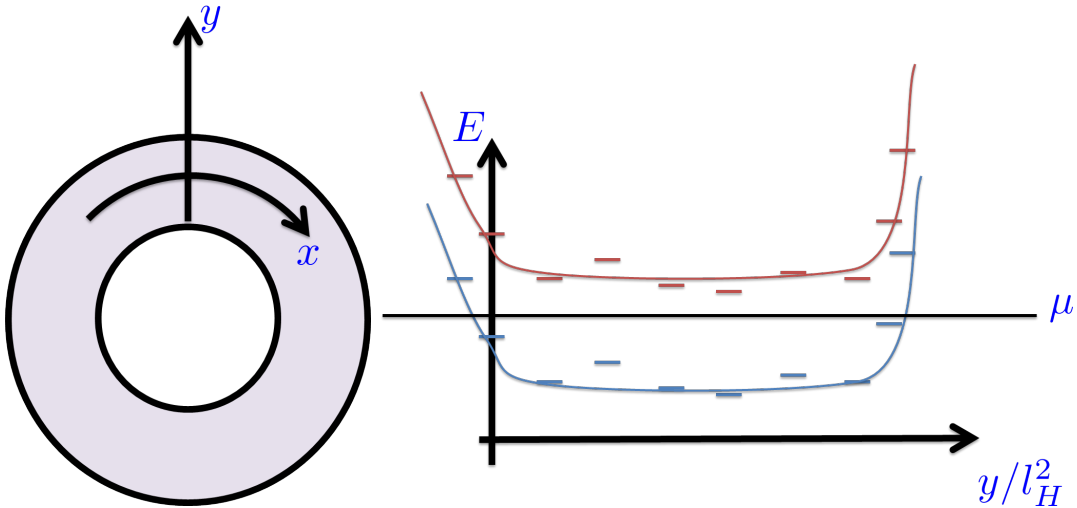

Figure 18: (a) Corbino geometry. (b) The $n_{\text{Landau}} = 0, 1$ Landau levels, in the presence of disorder the level is broadened, at strong magnetic field away from the Landau level center the states are localized. (Zeeman effect that splits the level further is not shown here). Near the edges of the sample we have extended states.

Having this rough picture in mind we can understand qualitatively the integer quantum Hall effect.

1. The first and most crucial observation of plateaus: As we increase the external magnetic field or decrease the electron density by reducing the chemical potential the filling factor ν crosses integer values. Since the states between the Landau levels are localized and can not conduct we observe conduction plateaus.

The fractional case is much more delicate and goes beyond the scope of this course.

- Effect of disorder: An increase in the disorder will make the plateaus wider as more states between the Landau level are localized and do not contribute to the conductance as we change the chemical potential.

Interestingly from the third experimental observation, i.e., the exponential temperature dependence of the resistances we can conclude that there is a gap in the system. This will lead us later on to a set of conclusions.

- In the classical limit we saw that due to the matrix structure of the resistance both the conductance and the resistance are small compared to the off diagonal terms.⁸

Experimentally it is observed that both

$$\frac{\rho_{xx}}{h/e^2} \sim e^{-T_0/T}$$

and we expect that also the conductance will have similar exponential dependence on the temperature.

As we know the dissipative conductance is related to the rate W of absorbing external electro-magnetic field $W \sim \vec{J}\vec{E} \sim \sigma E^2$. To calculate this rate we can use the standard Fermi golden rule:

$$W \sim \sum_{\text{initial states}} \frac{e^{-\epsilon_i/t}}{z} \sum_{\text{final states}} \hbar\omega |\langle f|H'|i\rangle|^2 (\delta(\epsilon_f - \epsilon_i - \omega) + \delta(\epsilon_f - \epsilon_i + \omega)),$$

with H' presenting the interaction of the electrons in our sample with the external EM field. ϵ_i the energy of the initial state and ϵ_f the energy of the final states. Since we are interested in the limit of $\omega = 0$ we have to require $\epsilon_f \sim \epsilon_i$. If there is a gap in the system then the factor $\propto e^{-\epsilon_i/T}$ will yield an exponential dependence in the temperature.

12.4 Additional conclusions, based on the existence of a gap in the system

12.4.1 Edge states

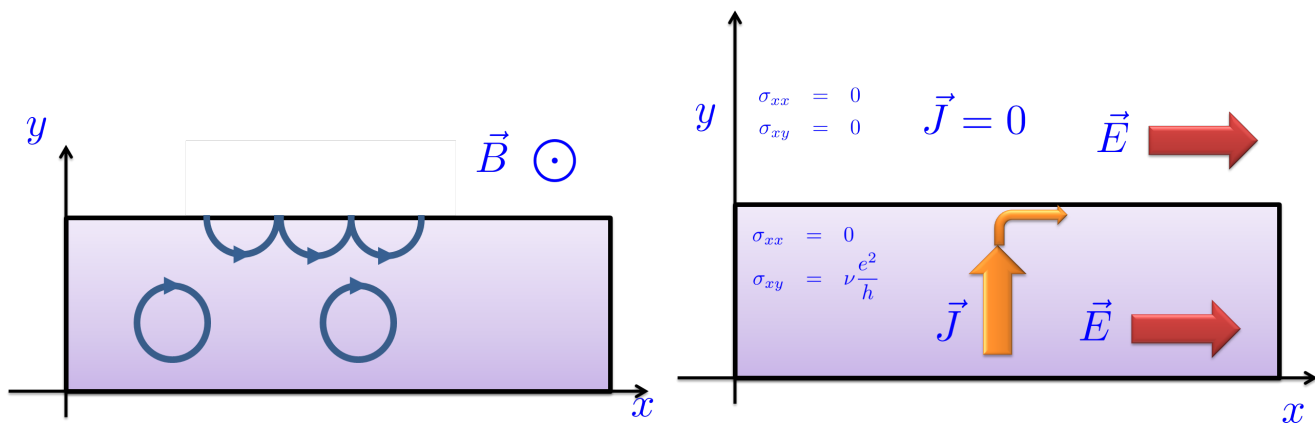

Figure 19: (a) Semiclassically: in the bulk electrons move in circles and near the edge in skipping orbits. (b) When we have a gap we find $\sigma_{xx} = 0$, then on the boundary separating $\sigma_{xy} \neq 0$ and $\sigma_{xy} = 0$ we must have an edge state.

Due to the exponential dependence on the temperature we expect that at zero temperature $\sigma_{xx} \approx 0$ so that the electrons move perpendicularly both to the electric field and to the magnetic field. We saw that

$$\sigma_{xy} = \frac{\nu e^2}{h}, \sigma_{xx} = 0$$

⁸Notice that in thin sample the resistance is $R_{xx} = \rho_{xx}L_x/(L_yd)$ so that for a square sample with $L_x = L_y$ the resistance R is equal to the resistivity ρ/d . Similarly the conductance G is equal to the conductivity σ times the thickness d . We therefore usually do not distinguish between conductivity and conductance (per square) or resistivity and resistance per square when discussing 2D systems.

and since the current is perpendicular to both the magnetic and electric field, if we look at an edge parallel to the electric field we have a current towards the edge. As we reach the edge, since charge can not be accumulated on the edge, we must have a current parallel to the edge.

This can be explained semiclassically in terms of skipping orbits performed by electrons near the edge. As we already so the motion of the electrons is perpendicular to both E and B the edge its self exert an electric field on the electrons perpendicular to the edge so that electron will move along the edge.

12.4.2 Fractional charges (Laughlin)

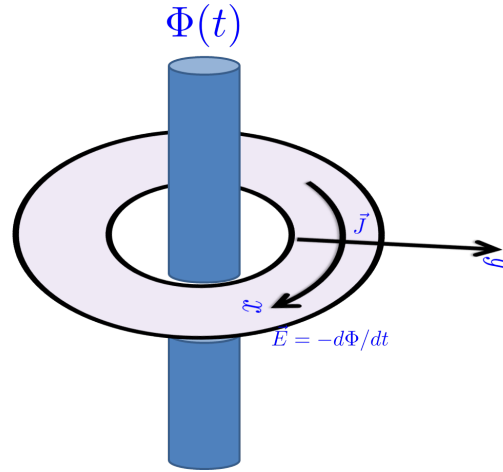

Figure 20: A change of the flux by ϕ_0 does not change the spectrum but push charges from edge to edge.

Noting $\sigma_{xy} = \nu \frac{e^2}{h}$ we will show now (following an argument by Laughlin) that there are fractional charges in the system. To do so we will use two important concepts:

1. **The adiabatic principle:** Assume that the system has a gap E_g for excitations above the (non degenerate) ground state $|\Psi(R(t))\rangle$. When we change the parameters $R(t)$ controlling the system at a slow rate Γ such that $E_g \gg \hbar\Gamma$ then the system will follow the ground state $|\Psi(R(t))\rangle$ (and will not be excited to a different state).
2. **Gauge invariance:** Byers and Yang (1961): showed using gauge invariance, that spectra of rings threaded by flux are periodic in the flux with period of the flux quantum $\phi_0 = h/e$. The Byers and Yang theorem is valid also in the presence of disorder and electron electron interaction.

Assuming we have a solenoid passing through the core of the system and we slowly (compared to the gap in the system) increase the flux. This generates an electric field in the \hat{x} direction. (See Fig. 20) As there is a constant magnetic field perpendicular to the sample a Hall current will flow perpendicular to \vec{B} and \vec{E} , which will cause electrons to flow outward towards the edge.

From gauge invariance, after changing the flux by a flux quantum ϕ_0 we must return to the original spectrum. Hence the total charge transferred between the edges is:

$$\Delta Q = \int I_y dt = \int J 2\pi r dt = \sigma_{xy} \int 2\pi r E dt = \sigma_{xy} \int \frac{\partial \Phi}{\partial t} dt = \sigma_{xy} \Delta \Phi$$

Using $\delta \Phi = \phi_0 = h/e$ we obtain: $\Delta Q = \nu \frac{e^2}{h} \frac{h}{e} = \nu e$

i.e. a fractional charge was transferred from edge to edge.

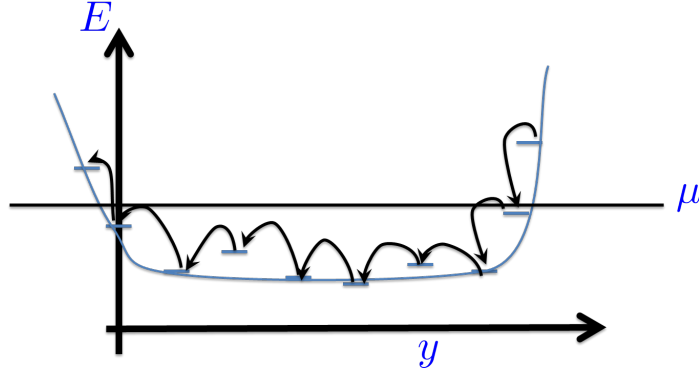

Figure 21: A change of the flux adiabatically move the Landau states. At ϕ_0 each state is replacing its neighbor position.

12.4.3 Quantization of Hall conductance in the integer case

In the presence of the flux the boundary condition on k_x after Eq. (149) are modified so that $e^{ik_x L} = e^{i2\pi\Phi(t)/\phi_0}$ which gives:

$$k_x(t) = \frac{2\pi}{L} \left(n + \frac{\Phi(t)}{\phi_0} \right).$$

Pictorially, the parabolas of the Landau levels are adiabatically moving in the y direction until for $\Phi(t) = \phi$ each parabola substitution the position of its neighbor. For the $\nu = 1$ case each state was filled exactly by 1 electron so that in this process 1 electron was transected from edge to edge. So that we have:

$$e = \Delta Q = \int I_y dt = \int J 2\pi r dt = \sigma_{xy} \int 2\pi r E dt = \sigma_{xy} \int \frac{\partial \Phi}{\partial t} dt = \sigma_{xy} \Delta \Phi$$

hence for a change of one flux quantum

$$\sigma_{xy} = \frac{e}{\Phi_0} = \frac{e^2}{h}$$

12.4.4 Quantization of the Hall conductance and Chern numbers using Linear response

In this subsection we are following an argument by Thouless that lead to quantization of the Hall conductance. This argument is very similar to Laughlin arguments mentioned above and also related to works by Berry (The Berry phase) and Avron. It is based on a formalism that is called "The Linear Response" formalism.

the y direction, see Fig. 26

In the presence of electric field the Hamiltonian of Eq. (148) is modified by adding a term

$$\delta H = e\mathcal{E}x$$

where \mathcal{E} is the applied electric field in the x direction. For $\mathcal{E} = 0$ we must have

$$J_y = \langle \Psi_0 | \hat{J}_y | \Psi_0 \rangle = 0.$$

Here $|\Psi_0\rangle$ is the many body ground state. We now assume that \mathcal{E} is small and calculate the change in the current using perturbation theory.

The first order perturbation theory (in the operator $\mathcal{E}\hat{x}$) for the ground state gives

$$\delta |\Psi_0\rangle = \sum_{m \neq 0} \frac{\hat{x}_{0m}}{E_0 - E_m} |m\rangle.$$

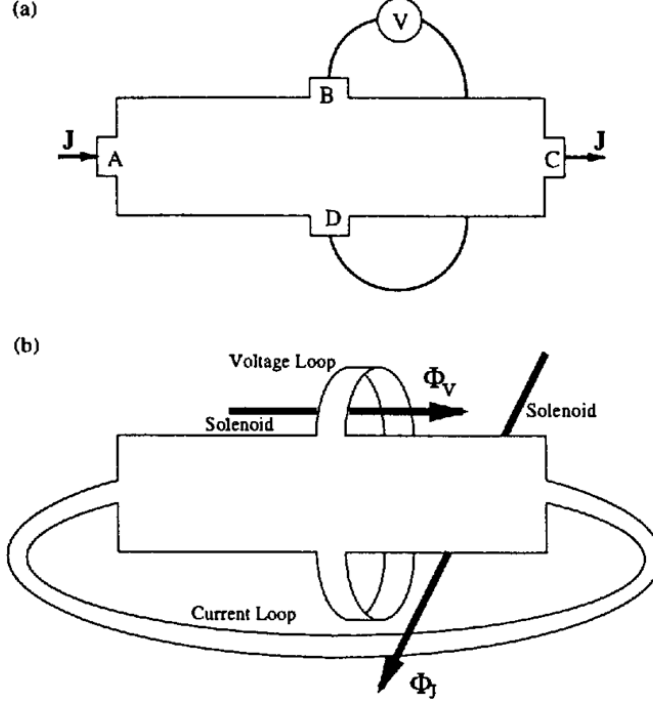

Fig. 14. The Hall bar, with current and voltage leads, shown in (a) can be replaced by the arrangement shown in (b), where the voltage is supplied by changing flux Φ_V through one loop, and the current is monitored by observing changes of the flux Φ_J through the other loop.

Figure 22: This figure is taken from Thouless []

Writing it in a slightly different and compact form, that will simplify the notation later we have:

$$\delta |\Psi_0\rangle = e\mathcal{E} \frac{\mathcal{P}}{E - \hat{H}} \hat{x} |\Psi_0\rangle \left[= e\mathcal{E} \sum_m \frac{\mathcal{P}}{E - \hat{H}} |m\rangle \langle m| \hat{x} |\Psi_0\rangle = \sum_{m \neq 0} \frac{e\mathcal{E}}{E_0 - E_m} x_{m0} \right]$$

where \mathcal{P} is a projection operator that projects out the ground state and $E = E_0$.

Similarly we have for the bra part of the ground state:

$$\delta \langle \Psi_0| = e\mathcal{E} \langle \Psi_0| \hat{x} \frac{\mathcal{P}}{E - \hat{H}}.$$

Combining the expressions we find:

$$\begin{aligned} \langle \Psi| \hat{J}_y |\Psi\rangle &= (\langle \Psi_0| + \delta \langle \Psi_0|) \hat{J}_y (|\Psi_0\rangle + \delta |\Psi_0\rangle) \\ &= e\mathcal{E} \left(\left\langle \Psi_0| \hat{J}_y \frac{\mathcal{P}}{E - \hat{H}} \hat{x} |\Psi_0\rangle + \left\langle \Psi_0| \hat{x} \frac{\mathcal{P}}{E - \hat{H}} \hat{J}_y |\Psi_0\rangle \right\rangle \right). \end{aligned} \quad (151)$$

In addition we have the relation

$$\hat{J}_x = e \frac{\partial \hat{x}}{\partial t} = \frac{ei}{\hbar} [\hat{H}, \hat{x}] \Rightarrow$$

$$-i\frac{\hbar}{e}J_x|\Psi_0\rangle = [\hat{H}, \hat{x}]|\Psi_0\rangle = (H - E)\hat{x}|\Psi_0\rangle \Rightarrow$$

$$\hat{x}|\Psi_0\rangle = \frac{i\hbar}{e} \frac{\mathcal{P}}{E - \hat{H}} J_x |\Psi_0\rangle. \quad (152)$$

Substituting Eq. (152) (and a similar expression for the bra term.) in Eq. (151) we obtain

$$J_y = -i\hbar\mathcal{E} \left\langle \Psi_0 \left| \hat{J}_y \frac{\mathcal{P}}{(E - \hat{H})^2} \hat{J}_x - \hat{J}_x \frac{\mathcal{P}}{(E - \hat{H})^2} \hat{J}_y \right| \Psi_0 \right\rangle \quad (153)$$

We can continue and express the current operators in a different form. Closing the two leads in each direction to form a loop which allows to pass a flux through it, using the relation

$$\hat{J} = \frac{\delta H}{\delta A}, \quad (154)$$

and defining Φ_v as the flux through the loop in the plane perpendicular to \hat{y} and Φ_J as the flux in the loop in the plane perpendicular to \hat{x} (see Fig. 26) we have

$$\hat{J}_x = \frac{\partial H}{\partial \Phi_v}, \quad \hat{J}_y = \frac{\partial H}{\partial \Phi_J}.$$

Substituting in Eq. (153) we have:

$$\sigma_H(\Phi_v, \Phi_J) = i\hbar \left\langle \Psi_0 \left| \frac{\partial H}{\partial \Phi_J} \frac{\mathcal{P}}{(E - \hat{H})^2} \frac{\partial H}{\partial \Phi_v} - \frac{\partial H}{\partial \Phi_v} \frac{\mathcal{P}}{(E - \hat{H})^2} \frac{\partial H}{\partial \Phi_J} \right| \Psi_0 \right\rangle.$$

We can further simplified the expression by noting that writing

$$H = H_0 + \frac{\partial H}{\partial \Phi_v} \delta \Phi_v$$

we have

$$\delta|\Psi\rangle = \delta\Phi_v \frac{\mathcal{P}}{E - H} \frac{\partial H}{\partial \Phi_v} |\Psi_0\rangle$$

giving

$$\left| \frac{\partial H}{\partial \Phi_v} \right\rangle = \frac{\mathcal{P}}{E - H} \frac{\partial H}{\partial \Phi_v} |\psi_0\rangle$$

and hence

$$\sigma_H = i\hbar \left(\left\langle \frac{\partial \psi_0}{\partial \Phi_v} \left\| \frac{\partial \psi_0}{\partial \Phi_J} \right\rangle - \left\langle \frac{\partial \psi_0}{\partial \Phi_J} \left\| \frac{\partial \psi_0}{\partial \Phi_v} \right\rangle \right).$$

Since the result cannot depend on the flux we used to perturb the system and create an electric field (as long as there is a gap in the spectrum), we can integrate over it and find:

$$\sigma_H = i\hbar \left(\frac{e}{\hbar} \right)^2 \int_0^{h/c} d\Phi_J \int_0^{h/c} d\Phi_v \left(\left\langle \frac{\partial \psi_0}{\partial \Phi_v} \left\| \frac{\partial \psi_0}{\partial \Phi_J} \right\rangle - \left\langle \frac{\partial \psi_0}{\partial \Phi_J} \left\| \frac{\partial \psi_0}{\partial \Phi_v} \right\rangle \right) \equiv i\hbar \left(\frac{e}{\hbar} \right)^2 \int_0^{h/c} d\Phi_J \int_0^{h/c} d\Phi_v B.$$

Due to the periodicity in $\phi_0 = h/e$ (due to the gauge invariance) both in Φ_v and Φ_J the space of the fluxes forms a torus.

We can define a Berry curvature B and Berry connection A which obey

$$\nabla \times A = B$$

$$\vec{A} = \frac{1}{2} \left(\left\langle \frac{\partial \Psi_0}{\partial \Phi_J} \middle| \Psi_0 \right\rangle - \left\langle \psi_0 \middle| \frac{\partial \Psi_0}{\partial \Phi_J} \right\rangle, \left\langle \frac{\partial \psi_0}{\partial \Phi_v} \middle| \psi_0 \right\rangle - \left\langle \psi_0 \middle| \frac{\partial \psi_0}{\partial \Phi_v} \right\rangle \right).$$

Notice that \vec{A} is in fact given by the gradient of the argument of the wave function indeed, if we write $|\Psi_{0,\Phi_J,\Phi_v}\rangle = \Psi_{0,\Phi_J,\Phi_v}(\{x_i\}) = r_{\Phi_J,\Phi_v}(\{x_i\}) e^{i\eta_{\Phi_J,\Phi_v}(\{x_i\})}$, with the set $\{x_i\}$ being the set of the location of all the particles we have (suppressing the arguments in the middle terms):

$$i \operatorname{Im}(\langle \Psi_0 | \partial_{\Phi} \Psi_0 \rangle) = \frac{1}{2} i \int \prod_i dx_i \operatorname{Im}(r' e^{i\eta} r e^{-i\eta} + i\eta' r^2 e^{i\eta} e^{-i\eta} + c.c.) = i \int \prod_i dx_i r^2 \frac{\partial \eta}{\partial \Phi} = i \frac{\partial \langle \eta \rangle}{\partial \Phi} \equiv i \frac{\partial \eta}{\partial \Phi}$$

hence

$$\vec{A} = \left(\frac{\partial \eta}{\partial \Phi_J}, \frac{\partial \eta}{\partial \Phi_v} \right).$$

We now have to perform the integral. We use Stokes' theorem to convert the integrals to ones over A.

$$\int B dv = \int \nabla \times A dv = \oint A ds$$

Since the integral is on a torus we have to be a bit careful.

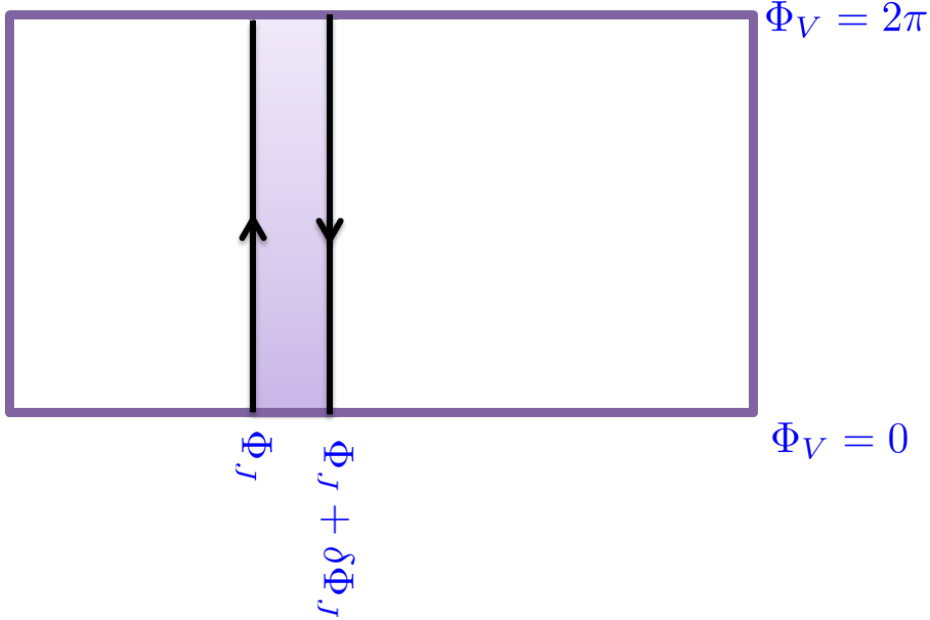

Figure 23: The integration contour for the calculation of the Chern number

We first integrate on loops of Φ_v at different values of Φ_J . This integral will give the flux through that slice.

$$\oint A(\Phi_J + \delta\Phi_J) d\Phi_v - \oint A(\Phi_J) d\Phi_v = \eta(\Phi_J + \delta\Phi_J) - \eta(\Phi_J) = \frac{\partial \eta}{\partial \Phi_J} \delta\Phi_J.$$

And now it remain to integrate on the loop of Φ_J :

$$\oint \frac{\partial \eta}{\partial \Phi_J} d\Phi_J = \eta(2\pi) - \eta(0) = 2\pi n$$

The last equal sign is correct because η is a phase on a loop and must return to its value $\text{mod } 2\pi$ after the rotation so that the wave function is unique.

Substituting in the expression for the conductance we find finally

$$\sigma_H = \frac{e^2}{h} n$$

with n defined as the Chern number, which we have shown is an integer.

13 Introduction to Graphene (Tutorial)

This chapter should be taught at the beginning of the course. Discuss to conversion of tight binding! discuss 1D model to avoid double counting!

13.1 Tight binding models

We would like to analyze the general problem of non-interacting electrons in a periodic potential that results from a lattice of ions. We note that the tight binding method is more general than what is presented here. If you would like to learn more, the book by Ashcroft and Mermin has a very good chapter on this subject.

In first quantization, we write the corresponding Schrodinger equation as

$$\left(-\frac{\hbar^2}{2m}\nabla^2 + V_{ion}(\vec{r})\right)\psi(\vec{r}) = E\psi(\vec{r}), \quad (155)$$

with $V_{ion}(\vec{r}) = \sum_{\mathbf{R}} V_i(\vec{r} - \vec{R})$. Here, $V_i(\vec{r})$ is the contribution to the potential from a single ion located in the origin, and the set of vectors \vec{R} are the lattice vectors.

We start by approaching the problem from the limit where the ions are extremely far apart. In this limit, the single-particle eigenstates will be those that correspond to the problem of an electron affected by a single ion:

$$\left(-\frac{\hbar^2}{2m}\nabla^2 + V_i(\vec{r})\right)\phi_n(\vec{r}) = E_n\phi_n(\vec{r}). \quad (156)$$

The solutions are bound to the corresponding ion, hence the name tight binding.

Once the spatial extent of the single ion wavefunctions becomes comparable to the lattice spacing, this stops being true, and coupling between different sites must be taken into account. However, within the tight binding formalism, we write the corrections to the above ideal picture in terms of the localized wavefunctions ϕ_n .

The coupling between $\phi_n(\vec{r})$ and $\phi_n(\vec{r} - \vec{R})$, which correspond to different ions introduces matrix elements of the form

$$\langle \phi_n(\vec{r} - \vec{R}) | H | \phi_n(\vec{r}) \rangle \equiv -t_n(\vec{R}). \quad (157)$$

Working in second quantization, we define an operator $c_n^\dagger(\vec{R})$ that creates an electron in the state $\phi_n(\vec{r} - \vec{R})$. In terms of these, we write the Hamiltonian in the quadratic form

$$H = - \sum_{n, \mathbf{R}, \mathbf{R}'} t_n(\vec{R} - \vec{R}') c_n^\dagger(\vec{R}) c_n(\vec{R}'). \quad (158)$$

13.2 Graphene

Graphene is a material made of a single atomic layer. This two dimensional system is made of Carbon atoms, arranged in a honeycomb lattice, as depicted in figure 24a.

Remember that a honeycomb lattice is actually an hexagonal lattice with a basis of two ions in each unit cell. If a is the distance between nearest neighbors, the primitive lattice vectors can be chosen to be

$$\vec{a}_1 = \frac{a}{2} (3, \sqrt{3}), \vec{a}_2 = \frac{a}{2} (3, -\sqrt{3}),$$

and the reciprocal-lattice vectors are spanned by

$$\vec{b}_1 = \frac{2\pi}{3a} (1, \sqrt{3}), \vec{b}_2 = \frac{2\pi}{3a} (1, -\sqrt{3}).$$

The first Brillouin zone is shown in figure 24b.

In this tutorial we want to calculate the spectrum of non-interacting electrons in this material. We restrict ourselves here to the case of nearest-neighbor tunneling terms only. In the homework, you will extend this to slightly more complicated

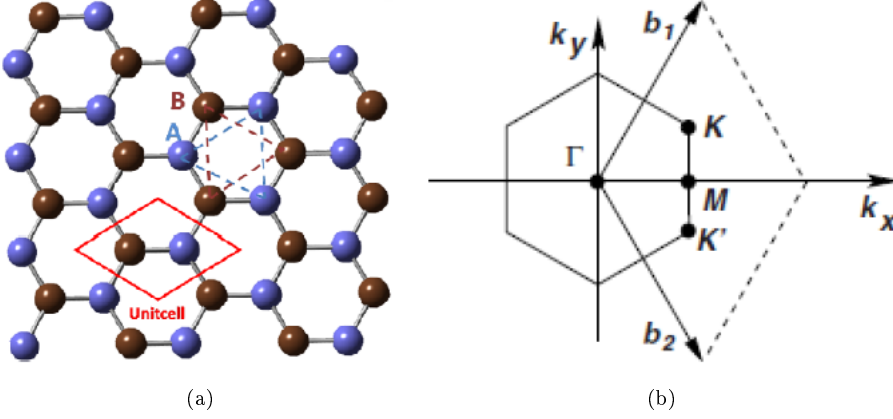

Figure 24

situations, and you will see that the important features of the spectrum remain the same as long as very large deviations are not included.

We directly work in second quantization, and define the annihilation operators of an electron at the lowest orbital centered around atoms A and B :

$$A(\vec{R}), B(\vec{R}).$$

These operators satisfy the anti-commutation relations

$$\begin{aligned} \{A(\vec{R}), A^\dagger(\vec{R}')\} &= \{B(\vec{R}), B^\dagger(\vec{R}')\} = \delta_{\vec{R}, \vec{R}'}, \\ \{A(\vec{R}), A(\vec{R}')\} &= \{B(\vec{R}), B(\vec{R}')\} = \{A(\vec{R}), B(\vec{R}')\} = \{A(\vec{R}), B^\dagger(\vec{R}')\} = 0. \end{aligned}$$

Notice that the nearest neighbor of an ion of type A is always an ion of type B (and vice versa). We therefore write the tight binding Hamiltonian as

$$H = -t \sum_{\langle \vec{R}, \vec{R}' \rangle} A^\dagger(\vec{R})B(\vec{R}') + h.c. = -t \sum_{\vec{R}, \vec{\delta}} A^\dagger(\vec{R})B(\vec{R} + \vec{\delta}) + h.c.$$

The vectors $\vec{\delta}$, connecting the A atoms to their nearest neighbors are given by

$$\vec{\delta}_1 = \frac{a}{2} (1, \sqrt{3}), \vec{\delta}_2 = \frac{a}{2} (1, -\sqrt{3}), \vec{\delta}_3 = a(-1, 0).$$

We want to diagonalize the Hamiltonian. Since we have a translation invariant system, it is a good idea to go to Fourier space and write

$$A(\vec{R}) = \frac{1}{\sqrt{N}} \sum_{\vec{k} \in BZ1} A(\vec{k}) e^{i\vec{k} \cdot \vec{R}}, B(\vec{R}) = \frac{1}{\sqrt{N}} \sum_{\vec{k} \in BZ1} B(\vec{k}) e^{i\vec{k} \cdot \vec{R}}.$$

Like the operators in real space, the non-vanishing anti-commutation relations are

$$\{A(\vec{k}), A^\dagger(\vec{k}')\} = \{B(\vec{k}), B^\dagger(\vec{k}')\} = \delta_{\vec{k}, \vec{k}'},$$

and the rest are zero. Plugging this into the Hamiltonian, we now have

$$\begin{aligned} H &= -t \sum_{\vec{R}, \vec{\delta}} A^\dagger(\vec{R})B(\vec{R} + \vec{\delta}) + h.c. = -\frac{t}{N} \sum_{\vec{R}, \vec{\delta}} \sum_{\vec{k}, \vec{q}} e^{i\vec{q} \cdot \vec{\delta}} e^{i\vec{R} \cdot (\vec{q} - \vec{k})} A^\dagger(\vec{k})B(\vec{q}) + h.c. = \\ &= -t \sum_{\vec{\delta}} \sum_{\vec{k}, \vec{q}} e^{i\vec{q} \cdot \vec{\delta}} A^\dagger(\vec{k})B(\vec{q}) \left(\frac{1}{N} \sum_{\vec{R}} e^{i\vec{R} \cdot (\vec{q} - \vec{k})} \right) + h.c. \end{aligned}$$

Using the fact that $\frac{1}{N} \sum_{\vec{R}} e^{i\vec{R} \cdot (\vec{q} - \vec{k})} = \delta_{\vec{q}, \vec{k}}$, we get

$$H = -t \sum_{\vec{k}, \delta} e^{i\vec{k} \cdot \delta} A^\dagger(\vec{k}) B(\vec{k}) + h.c.$$

If we define $\psi(\vec{k}) = \left(A(\vec{k}), B(\vec{k}) \right)^T$, we can rewrite this as

$$H = \sum_{\vec{k}} \psi^\dagger(\vec{k}) h(\vec{k}) \psi(\vec{k}),$$

where the matrix h , called the Bloch Hamiltonian, takes the form

$$h = \begin{pmatrix} 0 & f(\vec{k}) \\ f^*(\vec{k}) & 0 \end{pmatrix},$$

with $f(\vec{k}) = -t \sum_{\delta} e^{i\vec{k} \cdot \delta} = -t \left(e^{-ik_x a} + 2e^{ik_x a/2} \cos\left(\frac{k_y a \sqrt{3}}{2}\right) \right)$.

Since h is an Hermitian matrix, it is guaranteed that we can diagonalize it using some unitary matrix U , such that

$$U h U^\dagger = \begin{pmatrix} \varepsilon_+ & 0 \\ 0 & \varepsilon_- \end{pmatrix}.$$

Defining $U\psi = (c_+, c_-)^T$, we can write

$$H = \sum_{\vec{k}} \varepsilon_+(\vec{k}) c_+^\dagger(\vec{k}) c_+(\vec{k}) + \varepsilon_-(\vec{k}) c_-^\dagger(\vec{k}) c_-(\vec{k}),$$

with the non-vanishing anti-commutation relations

$$\left\{ c_+^\dagger(\vec{k}), c_+(\vec{k}') \right\} = \left\{ c_-^\dagger(\vec{k}), c_-(\vec{k}') \right\} = \delta_{\vec{k}, \vec{k}'}$$

Notice that we have two bands, one for each element of the unit cell, and the corresponding energy spectra are given by $\varepsilon_\pm(\vec{k})$.

We understand that in order to get the spectrum, we need to diagonalize the Bloch Hamiltonian h .

The corresponding eigenvalues are given by

$$\varepsilon_\pm = \pm \left| f(\vec{k}) \right| = \pm t \sqrt{3 + 2 \cos(\sqrt{3} k_y a) + 4 \cos(\sqrt{3} k_y a/2) \cos(3k_x a/2)}.$$

The spectrum is shown in Fig. 25a.

13.3 Emergent Dirac physics

Notice that the two bands touch at some points in the first Brillouin zone. Since Graphene has one accessible electron per atom, we get by taking spin into account that the lower band is exactly filled. This means that if we would like to discuss small excitations above the ground state, the excitations that will contribute are those near the crossing points.

To write the low energy theory, we would therefore like to identify these points. We get them from the condition $f(\vec{k}) = 0$. The two real equations that result from this requirement are

$$\cos(k_x a) + 2 \cos(k_x a/2) \cos\left(\frac{k_y a \sqrt{3}}{2}\right) = 0 \tag{159}$$

$$-\sin(k_x a) + 2 \sin(k_x a/2) \cos\left(\frac{k_y a \sqrt{3}}{2}\right) = 0. \tag{160}$$

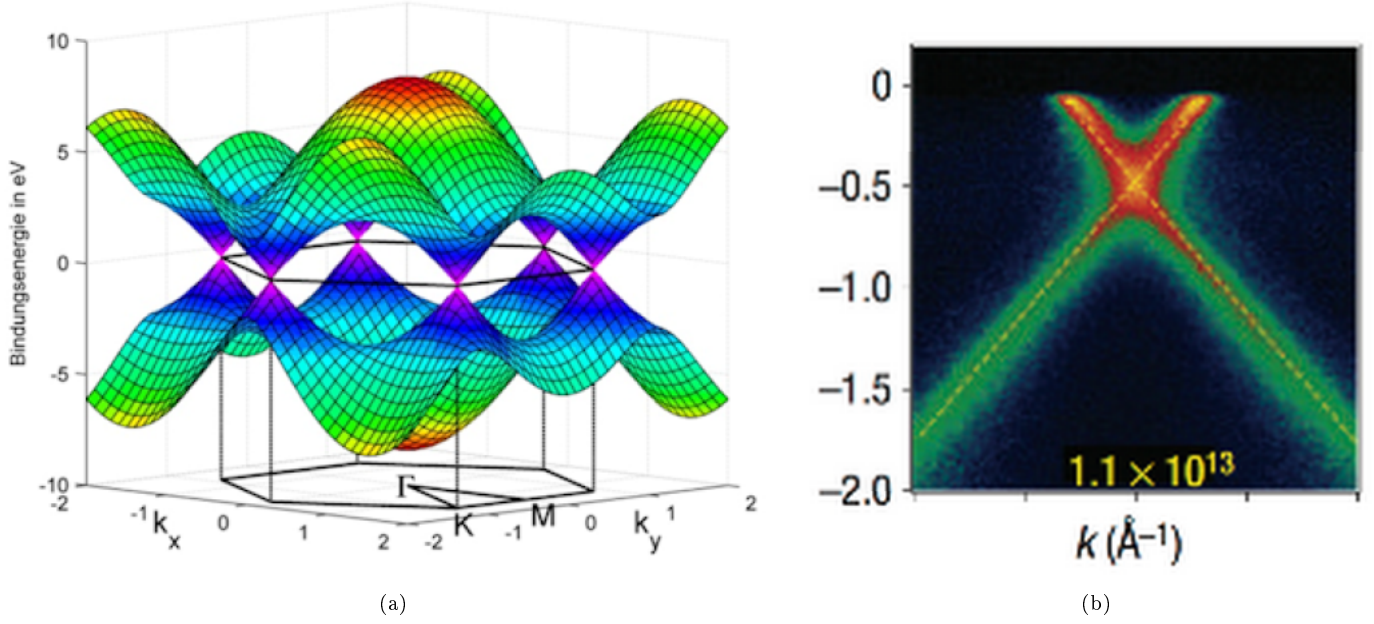

Figure 25

We can manipulate equation 160 such that it takes the form

$$\sin(k_x a/2) \left(-\cos\left(\frac{k_x a}{2}\right) + \cos\left(\frac{k_y a \sqrt{3}}{2}\right) \right) = 0.$$

So we have two options: either $\sin(k_x a/2) = 0$ (which means that $\cos(k_x a/2) = \pm 1$), or $\cos\left(\frac{k_x a}{2}\right) = \cos\left(\frac{k_y a \sqrt{3}}{2}\right)$.

The first option gives us the points $\left(0, \pm \frac{4\pi}{3\sqrt{3}a}\right)$ plus any reciprocal lattice vector. The second option gives us $\pm \frac{2\pi}{3a} \left(1, \frac{1}{\sqrt{3}}\right)$, and $\pm \frac{2\pi}{3a} \left(1, -\frac{1}{\sqrt{3}}\right)$ (again, up to reciprocal lattice vectors).

Actually, all the points listed above sit in the corners of the first Brillouin zone. A simple inspection shows that the above set of k-space vectors is not independent: the set of vectors $\left(0, \frac{4\pi}{3\sqrt{3}a}\right)$, $\frac{2\pi}{3a} \left(1, -\frac{1}{\sqrt{3}}\right)$, $\frac{2\pi}{3a} \left(-1, -\frac{1}{\sqrt{3}}\right)$ can be connected by a reciprocal lattice vector. This is correct for the set $\left(0, -\frac{4\pi}{3\sqrt{3}a}\right)$, $\frac{2\pi}{3a} \left(-1, \frac{1}{\sqrt{3}}\right)$, $\frac{2\pi}{3a} \left(1, \frac{1}{\sqrt{3}}\right)$ as well. To see this, we write

$$\left(0, \frac{4\pi}{3\sqrt{3}a}\right) + \vec{b}_2 = \frac{2\pi}{3a} \left(1, -\frac{1}{\sqrt{3}}\right) \quad (161)$$

$$\left(0, \frac{4\pi}{3\sqrt{3}a}\right) - \vec{b}_1 = \frac{2\pi}{3a} \left(-1, -\frac{1}{\sqrt{3}}\right). \quad (162)$$

The other equivalence relations result from taking linear combinations of the above equations. We choose one representative vector from each set. These are conventionally called K and K' :

$$\vec{K} = \frac{2\pi}{3a} \left(1, \frac{1}{\sqrt{3}}\right), \vec{K}' = \frac{2\pi}{3a} \left(1, -\frac{1}{\sqrt{3}}\right).$$

Remember that the energy bands cross at these points, and the gap closes. Because of that, there are two branches of low energy excitations - one of excitations with a given momentum close to K and another close to K' .

Therefore, if we would like to focus on the low energy physics, we expand the Hamiltonian around each of these points. Expanding around K' , for example, we get

$$f(\vec{K}' + \vec{q}) \approx -\frac{3ta}{2} e^{-\frac{2\pi i}{3}} (q_y + iq_x).$$

This means that the Hamiltonian can be approximated as

$$h(K' + \mathbf{q}) = -\frac{3ta}{2} \begin{pmatrix} 0 & e^{-\frac{2\pi i}{3}}(q_y + iq_x) \\ e^{\frac{2\pi i}{3}}(q_y - iq_x) & 0 \end{pmatrix}.$$

Upon changing the phases of A and B , which physically means changing the phases of the basis wavefunctions ϕ_n , this matrix can be brought to the form

$$h(\vec{K}' + \vec{q}) = \hbar v_F \vec{q} \cdot \vec{\sigma}, \quad (163)$$

where σ is the vector of Pauli-matrices. This is just the 2D massless Dirac Hamiltonian, which describes free relativistic electrons, where the speed of light has been replaced by $v_F = \frac{3ta}{2\hbar}$.

Remember that the Dirac Hamiltonian takes the form $H_{Dirac} = c \sum_i \alpha_i p_i + \beta m c^2$, where the matrices α and β satisfy the relations

$$\begin{aligned} \beta^2 &= 1 \\ \{\alpha_i, \beta\} &= 0 \\ \{\alpha_i, \alpha_j\} &= 2\delta_{ij}. \end{aligned}$$

The effective Hamiltonian in equation 163 takes exactly this form in 2D, if we identify $\alpha_i = \sigma_i$, and $m = 0$.

The eigenvalues and eigenfunctions of this equation are

$$E = \pm \hbar v_F |\vec{q}|, \psi_{\pm} = \frac{1}{\sqrt{2}} \begin{pmatrix} e^{i\theta_{\mathbf{q}/2} } & \\ & \pm e^{-i\theta_{\mathbf{q}/2} } \end{pmatrix}^T.$$

Here, $\theta_{\mathbf{q}}$ is the angle of the planar vector \vec{q} with respect to the x -axis.

Note that the phase of the wavefunction changes by π as \mathbf{q} winds around the origin, and completes a full winding as we wind twice around the origin. The phase after a full cycle does not depend on the trajectory. We can view this phase as a vortex, and the corresponding winding number as an integer which characterizes this Dirac cone. This is an example of a topological property, as it is insensitive to small deviations.

You will see in the homework how this topological property, together with the symmetries of the problem, makes it difficult to get rid of the Dirac cones. This means that the effective Dirac theory in our system is not an artifact of our nearest neighbor approximation, and can actually be expected to be observed in experiments. Indeed, the Dirac spectrum has been successfully measured (see Fig. 25b).

Note that a similar derivation would give us, $h(\vec{K} + \vec{q}) = h^*(\vec{K}' + \vec{q})$, and we get the same spectrum around K .

If we want to describe the full low energy theory, we have two independent Dirac modes, one around K and another around K' . It's therefore useful to work in a basis $\Psi = \left(A_{\vec{K}+\vec{q}}, B_{\vec{K}+\vec{q}}, A_{\vec{K}'+\vec{q}}, B_{\vec{K}'+\vec{q}} \right)$, in terms of which the full low energy Hamiltonian takes the form

$$h = v_F \begin{pmatrix} (\vec{q} \cdot \sigma)^* & 0 \\ 0 & \vec{q} \cdot \sigma \end{pmatrix}.$$

We have found emergent Dirac physics. The physical picture we have at large length scales (that is, small q 's) is completely different from the physics at the microscopic level. We started from a problem of non-relativistic electrons, and got that the low energy physics of the problem corresponds to that of relativistic fermions.

This is very exciting because now can use this fact to directly measure relativistic effects, and even some which have never tested in any particle physics experiment. As an example of such a property, the Klein paradox, where a relativistic electron, obeying the Dirac equation, is fully transmitted after hitting a very strong potential barrier, has been measured in Graphene.

14 Graphene – Quantum Hall effect without constant magnetic field

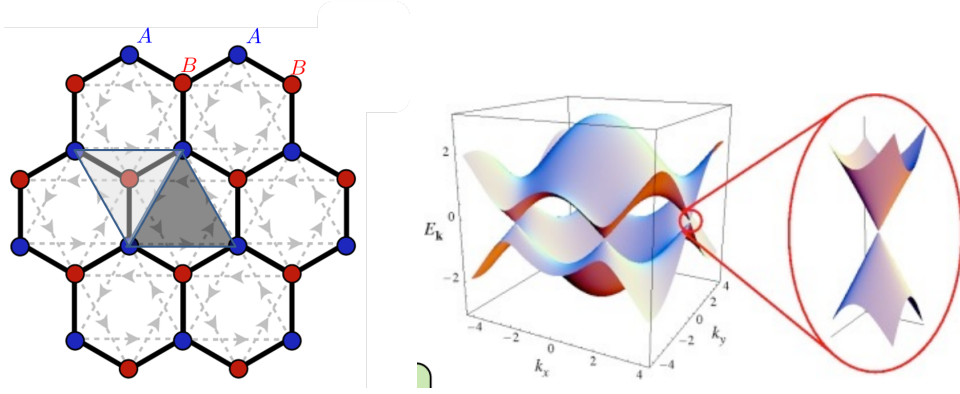

Figure 26: Haldane's Hamiltonian of Graphene with next nearest neighbor interactions finite flux in the shaded triangles and opposite flux in the complementary triangles

In this chapter we will show that a non zero Chern number leading to $\sigma_{xy} \neq 0$ and to the presence of edge modes can be obtained in a lattice. The basic idea is to take a magnetic field which is alternating within the unit cell such that on average it is zero and the system still posses translational invariance. In such a case the Chern number can be formulated as an integral over Berry curvature in the first Brillouin zone. As an example we will consider a Graphene sheet, which has hexagonal lattice structure.

14.1 Tight-binding approximation for Graphene

Carbon has four valence electrons, two of which fill the $2s$ orbital and two in the $2p$. The two p electrons form the covalent bands that glue the carbon atoms to each other. Each atom in the hexagonal structure (Fig.26) shares 3 bonds with it's nearest neighbors such that over all there is one electron per atom which does not participate in the bonding (it is anti-bonding). The repulsion of the existing bonding electrons pushes these free electrons away form the in-plane bonds into the p_z orbital state (pointing out of the plane).

Let us now turn to the lattice structure. The Bravais lattice is triangular with a basis containing a single additional site. One possible choice is to define the triangular Bravais lattice points on the blue sites named A in Fig.26 and then the B sites are the basis connected by one of the three lattice vectors to the Bravais lattice. The three lattice vectors are given by

$$\delta_1 = \frac{a}{2} (\sqrt{3}, -1), \delta_2 = \frac{a}{2} (-\sqrt{3}, -1), \delta_3 = a(0, 1).$$

The nearest neighbor tight binding approximation is obtained by computing the energy shift of the p_z states within degenerate perturbation theory

$$t = \langle p_z; \mathbf{R}_j | \delta \hat{H} | p_z; \mathbf{R}_j + \delta_a \rangle \quad (164)$$

where $\delta \hat{H}$ are terms in the Hamiltonian that hybridize neighboring sites.⁹ The resulting tight-binding Hamiltonian is then given by

$$H = -t \sum_{\langle ij \rangle} c_i^\dagger c_j \quad (165)$$

where the $\langle \rangle$ brackets denote summation over nearest neighbors.

14.2 Band structure - Dirac dispersion in quasi momentum

The solution of the Hamiltonian (165) is obtained by dividing the lattice operators $c_{\mathbf{R}}$ into to types belonging to the two sublattice sites A and B , and then transforming to momentum space $(c_{j,A}^\dagger, c_{j,B}^\dagger) = \frac{1}{\sqrt{N}} \sum_{\mathbf{k}} e^{-i\mathbf{k} \cdot \mathbf{R}_j} (c_{\mathbf{k},A}^\dagger, c_{\mathbf{k},B}^\dagger)$. The

⁹In the absence of any symmetry breaking term the only contribution to the hopping element t comes from the off-diagonal (not on site) elements of the electron-ion Coulomb interaction $t \approx \int d^3r \phi_{p_z}^*(\mathbf{r}) \frac{e^2}{|\mathbf{r} - \delta_a|} \phi_{p_z}(\mathbf{r} - \delta_a)$.

resulting Hamiltonian is given by

$$H = \sum_{\mathbf{k}} \begin{pmatrix} c_{\mathbf{k}A}^\dagger & c_{\mathbf{k}B}^\dagger \end{pmatrix} \begin{pmatrix} 0 & -t \sum_{a=1}^3 e^{-i\mathbf{k}\cdot\delta_a} \\ -t \sum_{a=1}^3 e^{i\mathbf{k}\cdot\delta_a} & 0 \end{pmatrix} \begin{pmatrix} c_{\mathbf{k}A} \\ c_{\mathbf{k}B} \end{pmatrix} = -t \sum_{\mathbf{k}} c_{\mathbf{k}}^\dagger \mathbf{d}(\mathbf{k}) \cdot \boldsymbol{\sigma} c_{\mathbf{k}} \quad (166)$$

where $\mathbf{d}(\mathbf{k}) = (2 \cos \frac{\sqrt{3}k_x a}{2} \cos \frac{k_y a}{2} + \cos k_y a, -2 \cos \frac{\sqrt{3}k_x a}{2} \sin \frac{k_y a}{2} + \sin k_y a)$ is a momentum dependent "magnetic field" for the pseudo spinor $c_{\mathbf{k}}^\dagger = (c_{\mathbf{k}A}^\dagger, c_{\mathbf{k}B}^\dagger)$ and \mathbf{s} is the vector of Pauli matrices acting in the same basis. Note that the Hamiltonian additionally two-fold degenerate due to real spin.

The dispersion which is simply the magnitude of the d-vector $\epsilon_{\pm}(\mathbf{k}) = \pm|\mathbf{d}(\mathbf{k})|$, is plotted in Fig.26.

The most striking feature of this dispersion is the existence of two Dirac cones in each Brillouin zone, which are located at the two K-points

$$K = \frac{2\pi}{3a} \left(\frac{1}{\sqrt{3}}, 1 \right), K' = \frac{4\pi}{3\sqrt{3}a} (1, 0)$$

Expanding the Hamiltonian around these two points yields the two Dirac cones

$$\mathbf{d}(\mathbf{k} \sim K) \cdot \boldsymbol{\sigma} \approx v \left[\frac{1}{2}(\delta k_x + \sqrt{3}\delta k_y)\sigma^x + \frac{1}{2}(\sqrt{3}\delta k_x - \delta k_y)\sigma^y \right] \quad (167)$$

$$\mathbf{d}(\mathbf{k} \sim K') \cdot \boldsymbol{\sigma} \approx v [\delta k_x \sigma^x - \delta k_y \sigma^y] \quad (168)$$

where $\delta\mathbf{k}$ is the vector relative to K or K' and $v = 3ta/2$ is the velocity. Therefore, at low energy we can throw away the non-linear parts of the band structure and keep only two degenerate Dirac cones belonging to two valleys K and K' .

Note that the sub-lattice degree of freedom can be treated as a pseudo-spin which winds around each Dirac cone like a vortex according to the momentum dependent "magnetic field" $\mathbf{d}(\mathbf{k})$. In the K valley the pseudo-spin structure is of an anti-vortex whereas the K' one is a vortex. The vortex is a topological defect which is protected against smooth perturbations to the momentum distribution. This allows us to classify the type of perturbations that can "gap out" the Dirac cones (exercise).

14.3 The Haldane model

Following Haldane, PRL 61, 2015 (1988) we define a hopping Hamiltonian which includes next nearest neighbors interaction:

$$H = t_1 \sum_{\langle ij \rangle} c_i^\dagger c_j + t_2 \sum_{\langle\langle ij \rangle\rangle} e^{-i\nu_{ij}\phi} c_i^\dagger c_j + M \sum_i \varepsilon_i c_i^\dagger c_i \quad (169)$$

with ε_i = the on site energy . In Graphene all ε_i are identical, since they are all carbon atoms, but in other examples, like that of Boron Nitride where the A and B atoms are different the situation is modified. The gist of Haldane idea is to study situations with an alternating magnetic field whose average is zero. For example a situation for which triangles around the B atoms circling positive flux and the complementary triangles negative flux.

Formally, we can include the alternating magnetic field by adding phases to the second nearest neighbors hopping matrix elements. For example we can choose ν_{ij} in Eq. (169) to be:

$$\nu_{ij} = \text{sign} (\delta_i \times \delta_j)$$

where δ_i, δ_j are the vectors between sites i and j and the site between them. This ensures that a loop of 3 sites which contains a site gives a positive sign for ν while one that doesn't gives a negative sign. Any other choice of phases consistent with that condition is possible.

In Fourier space, choosing $\varepsilon_A = 1, \varepsilon_B = -1$ for the two sublattices we have:

$$H = \sum_{\mathbf{k}} c_{\mathbf{k}}^\dagger h(\mathbf{k}) c_{\mathbf{k}} \text{ with } h(\mathbf{k}) = \varepsilon(\mathbf{k})\mathbb{I} + d_i(\mathbf{k}) \cdot \sigma_i \quad (170)$$

$$\varepsilon(k) = 2t_2 \cos \phi \sum_i \cos(k \cdot \bar{\delta}_i)$$

$$d_1 = t_1 \sum_i \cos(k \cdot \delta_i), \quad d_2 = t_1 \sum_i \sin(k \cdot \delta_i), \quad d_3 = M - 2t_2 \sin \phi \left(\sum_i \sin(k \cdot \bar{\delta}_i) \right)$$

where $\bar{\delta}_1 = \delta_2 - \delta_3$, $\bar{\delta}_2 = \delta_3 - \delta_1$, $\bar{\delta}_3 = \delta_1 - \delta_2$ are the vectors connecting the next nearest neighbors.

Few symmetry properties of the Hamiltonian are noticeable. To study them let us first analyze the consequences that time-reversal has for Bloch Hamiltonians.

Time reversal symmetry

For spinless particles, T leaves the on-site creation operators unchanged, (unlike the case for spinful particles). We have:

$$Tc_jT^{-1} = c_j$$

where we can add any orbital indices to the creation operators as long as the index is not spin.

Using these rules we then have in the Fourier space:

$$Tc_jT^{-1} = \frac{1}{\sqrt{N}} \sum_k e^{-ikR_j} Tc_kT^{-1} = \frac{1}{\sqrt{N}} \sum_k e^{-ikR_j} Tc_kT^{-1}$$

In the above, the Fourier exponent was complex conjugated because of the action of the T operator on complex c numbers is to complex conjugate them. Hence the action of the time-reversal operator on the annihilation operator of an electron at momentum k just flips the sign of the momentum. In order to fulfill the condition $Tc_jT^{-1} = c_j$ we must have

$$Tc_kT^{-1} = c_{-k}$$

this forms the rules for time reversal transformation of spin less particles in the momentum space.

We are now ready to explore the condition for time reversal of a Bloch Hamiltonian $h(k)$. By definition in clean systems we have:

$$H = \sum_{ij} c_j^\dagger h_{i-j} c_i = \sum_k c_k^\dagger h(k) c_k$$

The time reversal operation will be then:

$$THT^{-1} = \sum_k c_{-k}^\dagger Th(k)T^{-1}c_{-k} = \sum_k c_{-k}^\dagger h^*(k)c_{-k},$$

we therefore conclude that THT^{-1} will be identical to H , i.e. will be time reversal invariant when $h^*(k) = h(-k)$.

Coming back to Haldane's Hamiltonian in Eq. (170) we note that for the special case of $\phi = 0, \pi$ time reversal symmetry is preserved.

Indeed at this point we have

$$\varepsilon(k)^* = \varepsilon(k) = \varepsilon(-k)$$

$$d_i(k)^* = d_i(k) = d_i(-k).$$

hence time reversal symmetry is preserved at these values of the flux.

In addition $h(k)$ unchanged also under the inversion symmetry I

$$I : \sigma_x h(-k) \sigma_x = h(k)$$

In the discussion of the conductivity using the fluxes we use Eq. (171) for the definition of current when the momentum k is a good quantum number the current can also be defined as:

$$\hat{J} = \frac{e}{\hbar} \frac{\delta H}{\delta k}, \quad (171)$$

The integration over the periodic fluxes is than substituted by an integration over a full Brillouin zone and we can also write the conductivity as

$$\sigma_{xy} = \frac{e^2}{h} \int_{\text{Full Brillouin Zone}} dk_x dk_y F_{yx}(k) \quad (172)$$

$$F_{xy} = \frac{\partial A}{\partial k_x} - \frac{\partial A}{\partial k_y} \quad (173)$$

$$A_j = -i \sum_{\text{Full bands}} \left\langle \alpha, \vec{k} \left| \frac{\partial}{\partial k_j} \right| \alpha, \vec{k} \right\rangle \quad (174)$$

where α is a band index. The Chern number is then given by:

$$\text{Ch} = \frac{1}{2\pi} \int_{FBZ} dk_x dk_y F_{yx}(k) = n \quad (175)$$

Generally when $h(k)$ is a 2×2 matrix (as in Eq. (170)) its diagonalization gives:

$$E_{\pm} = \varepsilon \pm d(k) = \varepsilon \pm \sqrt{d_1^2 + d_2^2 + d_3^2}$$

$$\psi_+ = \frac{1}{\sqrt{d(d+d_3)}} \begin{pmatrix} d_3 + d \\ d_1 - id_2 \end{pmatrix}, \psi_- = \frac{1}{\sqrt{2d(d+d_3)}} \begin{pmatrix} d_3 - d \\ d_1 - id_2 \end{pmatrix}$$

hence:

$$A_{ij} = i \langle \psi_- | \partial_{k_j} | \psi_- \rangle = -\frac{1}{2d(d+d_3)} (d_2 \partial_j d_1 - d_1 \partial_j d_2) \quad (176)$$

$$F_{ij} = \frac{1}{2} \varepsilon_{abc} \hat{d}_a \partial_i \hat{d}_b \partial_j \hat{d}_c \quad (177)$$

14.4 Chern number in Haldane's model and Obstruction of Stokes' theorem

14.4.1 Obstruction of Stokes' theorem

There is a nice topological interpretation for the integral of the k space. Due to the periodic boundary conditions the k variables span a two dimensional torus T^2 . On the other hand the unit vector $\hat{d}(k_x, k_y)$ is a point in the two dimensional sphere S^2 .

The expression for the Chern number in Eq, (175) forms a mapping from the torus (k) space to the sphere (d) space. i.e., $T^2 \mapsto S^2$.

It appears that the Berry curvature F is simply the Jacobian of this transformation, indeed according to the result of Eq. (177) we have:

$$F_{ij} = \frac{1}{2} \begin{vmatrix} \hat{d}_1 & \hat{d}_2 & \hat{d}_3 \\ \partial_{k_x} \hat{d}_1 & \partial_{k_x} \hat{d}_2 & \partial_{k_x} \hat{d}_3 \\ \partial_{k_y} \hat{d}_1 & \partial_{k_y} \hat{d}_2 & \partial_{k_y} \hat{d}_3 \end{vmatrix} = \sin \theta \begin{vmatrix} \frac{\partial \theta}{\partial k_x} & \frac{\partial \phi}{\partial k_x} \\ \frac{\partial \theta}{\partial k_y} & \frac{\partial \phi}{\partial k_y} \end{vmatrix}$$

in the last equation we used the standard spherical coordinate system

$$d_1 = \sin \theta \cos \phi, d_2 = \sin \theta \sin \phi, d_3 = \cos \theta$$

The expression for the Chern number is now:

$$\text{Ch} = \frac{1}{4\pi} \int_{\partial} \sin \theta d\theta d\phi,$$

but we have to determine the boundaries ∂ of integration.

To do so we neglect the ε which will not change the eigen vectors then the Hamiltonian is:

$$h(\vec{k}) = \varepsilon(\vec{k}k) + \sigma \cdot d(\vec{k}) \rightarrow \begin{pmatrix} \cos \theta & \sin \theta e^{-i\phi} \\ \sin \theta e^{i\phi} & -\cos \theta \end{pmatrix}$$

and the lower energy solution is:

$$\psi_I = \frac{1}{\sqrt{2d(d+d_3)}} \begin{pmatrix} d_3 - d \\ d_1 - id_2 \end{pmatrix} \rightarrow \begin{pmatrix} -e^{-i\phi} \sin \frac{\theta}{2} \\ \cos \frac{\theta}{2} \end{pmatrix}$$

which isn't defined at $\theta = 0$. On the other hand we can multiply by a phase and have

$$\psi_{II} = \begin{pmatrix} -\sin \frac{\theta}{2} \\ e^{i\phi} \cos \frac{\theta}{2} \end{pmatrix}$$

which isn't defined at $\theta = \pi$. Hence we can use each ψ only in the half sphere where it is well defined. We can then use Stokes' theorem to obtain that the integral over the sphere can be converted to two integrals over the respective Berry connections of the two half spheres on the equator, giving:

$$\frac{1}{4\pi} \int \cos \theta d\phi = \frac{1}{4\pi} \int (A_I - A_{II}) dl$$

where $A_j = i \langle \psi_j | \nabla | \psi_j \rangle$ is the Berry connection for the region where ψ_j is defined.

We can easily calculate A_I and A_{II} on the equator and find

$$A_I = \frac{i}{2} (e^{i\phi}, 1) \partial_\phi \begin{pmatrix} -e^{i\phi} \\ 1 \end{pmatrix} = 1$$

and similarly

$$A_{II} = -1$$

giving

$$\text{Ch} = \frac{1}{4\pi} \int 2d\phi = 1$$

The conclusion of these procedure, known as the obstruction of stokes theorem, is the following: if the vector d of the solution reaches both the north and the south poles of S^2 the Chern number is 1. If on the other hand d span only the north hemisphere then we can do the whole integration with one of the wave function shrink the loop of integration to a point and the Chern number is zero.

14.4.2 Chern number in Haldane's model

Coming back to Haldane's model in Eq. (170) we find the following results

for $\phi = 0$, $d_3(k) = M = \text{const}$ so clearly as we change k we will not get into the south pole and the Chern number is zero.

A more careful analysis of the dependance of $\vec{d}(k)$ on k (we will discuss that in the next section) shows that it is sufficient to discuss the behavior of d_3 near the special points K and K' . At these points:

$$d_3(K) = M - 3\sqrt{3}t_2 \sin \phi, \quad d_3(K') = M + 3\sqrt{3}t_2 \sin \phi$$

and we can use these values to see whether d reaches the south pole, which means we have non-zero Chern number. This gives the phase diagram

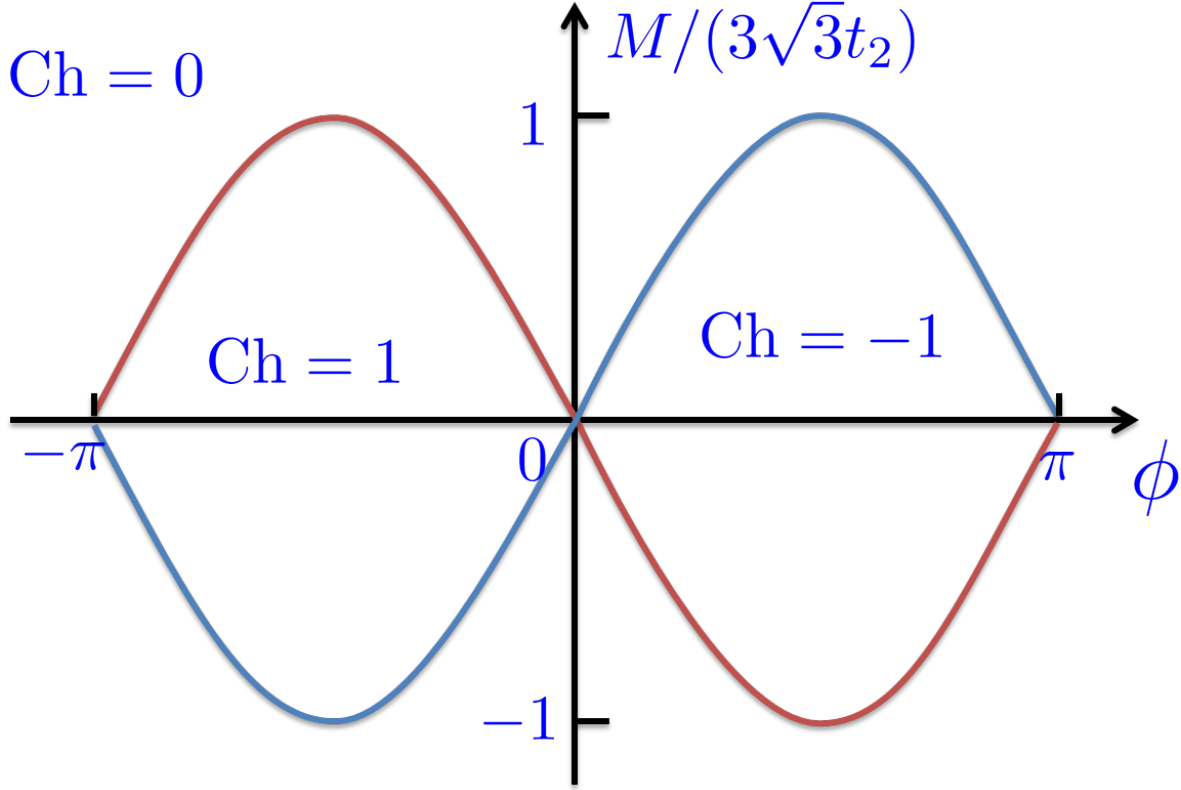

Figure 27: The Chern number for Haldane model

14.4.3 Chern number near a Dirac point

Developing the Hamiltonian around K, K' for the Haldane model in Eq. (170) we have:

$$\begin{aligned} H(k) &= -3t_2 \cos(\phi) + \frac{3}{2}t_1(k_x\sigma_x + k_y\sigma_y) + (M \mp 3\sqrt{3}t_2 \sin \phi) \sigma_z \\ &+ \frac{9}{4}t_2 \cos(\phi)(k_x^2 + k_y^2) + \frac{9}{4}\sqrt{3} \sin \phi t_2(k_x^2 + k_y^2) \sigma_z \end{aligned} \quad (178)$$

where the \mp is for K, K' respectively.

The linear part (divided by $3/2t_2$ with the relation $((M \mp 3\sqrt{3}t_2 \sin \phi) / (3/2t_2) = m_{\pm})$ gives

$$\begin{pmatrix} m_{\pm} & k_x - ik_y \\ k_x + ik_y & -m_{\pm} \end{pmatrix} = k_x\sigma_1 + k_y\sigma_2 + m_{\pm}\sigma_3$$

the Berry curvature near the massive Dirac point is given by

$$F_{xy} = \frac{m}{2(k^2 + m^2)^{3/2}}$$

So that we can easily calculate the Chern number:

$$\text{Ch} = \frac{1}{2\pi} \int \frac{m}{2(k^2 + m^2)^{3/2}} 2\pi k dk = \frac{m^3}{(m^2)^{3/2}} \int_0^\infty \frac{dy}{(1+y)^{3/2}} = \frac{\text{sign}(m)}{2}$$

The Chern number depends on the sign of m , and in the phase diagram the lines in fig 27 represent the values of M and ϕ where m is 0 and changes sign across them.

Notice that the Chern number that we got from the the analysis of the massive Dirac point is half integer. We prove however that it has to be a n integer. That occurs because we did not treat properly the other parts of the spectrum. The contribution of the other parts of the spectrum that must convert the Chern number to be an integer is called "the contribution of spectator fermions". The change of the mass, however, at the Dirac points give correctly the change of the Chern number. it jumps by one when the mass change its sign.

In order to determine the contribution of the spectator fermions (that in principle could be positive or negative) we examine the system in simple cases. In the so cold atomic limit when $M \rightarrow \infty$ we expect that system will not conduct at all, as there is a large gap and the electrons are localized on the atomic level. Thus for large M we expect that $\text{Ch} = 0$. The changes in the value of m gives the phase diagram of Fig. 27.

14.4.4 Explicit solution of edge mode in a massive Dirac spectrum

We show that a massive Dirac spectrum may have a Chern number that is not zero. From our studies of the Hall effect we expect that when the Chern number is not zero the system will have edge modes. Unlike the Hall effect the simple interpretation in terms of skipping orbits on the edges does not exist here.

In this subsection we will construct an explicit solution of the edge modes: In order to do so we assume that we have a semi infinite system for positive x and write H as:

$$H = H_x + H_y,$$

examine Eq. (178) we find

$$H_x = (C - Dk_x^2) + (m - Bk_x^2) \sigma_z + Ak_x \sigma_x$$

$$H_y = -Dk_y^2 - Bk_y^2 \sigma_z + Ak_y \sigma_y.$$

We want to solve this Hamiltonian on the edge of the model. We notice that the Dirac cone have a symmetry under rotations around the x axis which allows us to set initially

$$k_y = 0, H_y = 0$$

to assume that there is a solution at $E = 0$ and then treat H_y perturbatively. Then the Hamiltonian is:

$$\begin{pmatrix} C + D\partial_x^2 + m + B\partial_x^2 & iA\partial_x \\ -iA\partial_x & C + D\partial_x^2 - m - B\partial_x^2 \end{pmatrix} \psi_0 = E\psi_0.$$

We use an ansatz

$$\psi_0 = \bar{a}e^{\lambda x}$$

with \bar{a} being a two component vector. This yields

$$(m + B\lambda^2) \sigma_z \bar{a} = -i\sigma_x \bar{a} A\lambda,$$

multiplying by $i\sigma_x$ we find

$$(m + B\lambda^2) \sigma_y \bar{a} = \bar{a} A\lambda.$$

The eigenvalues of σ_y are

$$a_{\pm} = \frac{1}{\sqrt{2}} \begin{pmatrix} e^{i\pi/4} \\ \mp e^{-i\pi/4} \end{pmatrix}, \sigma_y a_{\pm} = \pm a_{\pm}.$$

Setting these in the equation we find

$$(m + B\lambda^2) a_{\pm} = \pm A\lambda a_{\pm}.$$

We have 2 quadratic equations with 4 solutions. 2 of them are

$$\lambda_{1,2} = \frac{1}{2B} \left(A \pm \sqrt{A^2 - 4MB} \right)$$

(for the other two take $A \rightarrow -A$) thus the eigenvectors are

$$\psi_0 = (ae^{\lambda_1 x} + be^{\lambda_2 x}) a_+ + (ce^{-\lambda_1 x} + de^{-\lambda_2 x}) a_-$$

We impose a boundary condition $\psi(0) = 0 \Rightarrow b = -a, d = -c$. The normalizability condition of the wave function will prevent ψ from exploding at infinity.

If $Re(\lambda_1) > 0$ and $Re(\lambda_2) < 0$ or vice versa the normalization can't be achieved without setting all coefficients to 0, hence in this situation there is no solution.

However, if $Re(\lambda_1) < 0$ and

$$\text{sign}(Re(\lambda_1)) = \text{sign}(Re(\lambda_2)),$$

which is satisfied if

$$\sqrt{A^2 - 4MB} < |A|$$

Then we have two options:

$$A/B < 0 \Rightarrow Re(\lambda_1, \lambda_2) < 0$$

$$A/B > 0 \Rightarrow Re(\lambda_1, \lambda_2) > 0$$

Giving solutions

$$\psi_0 = a (e^{\lambda_1 x} - e^{\lambda_2 x}) a_+, A/B < 0, Re(\lambda_1, \lambda_2) < 0$$

$$, c (e^{-\lambda_1 x} - e^{-\lambda_2 x}) a_-, A/B > 0, Re(\lambda_1, \lambda_2) > 0$$

We found that we have a 1D edge state with a linear dispersion relation if we perturb around it in the y direction.

$$\Delta E = \langle \psi_0 | H_y | \psi_0 \rangle \rightarrow A k_y$$

14.5 Topological insulators and Spin-orbit coupling, Kane and Mele Model (2005)

Given some magnetic field induced by movement in an electric field

$$\vec{B} = -\frac{\vec{v}}{c} \times \vec{E}$$

We add a spin-orbit interaction (?sign)

$$H_{so} = -\frac{1}{2}g\mu_B \vec{\sigma} \cdot \vec{B} \Rightarrow \frac{\hbar e}{2m^2c^2} \vec{\sigma} \cdot \vec{p} \times \vec{E} \frac{1}{2}$$

where the $\frac{1}{2}$ factor comes from an exact development of this term from the Dirac equation. In the case of the atom with a radial field with term will be proportional to $\sigma \cdot L$.

In matter SO coupling can be a significant effect due to the strong fields in the locality of ions, as opposed to freely propagating fermions. We can write

$$H_{so} = \frac{1}{2m} \left\{ \frac{e}{c} \vec{p} \cdot \left(\frac{\hbar}{4mc} \vec{\sigma} \times \vec{E} \right) + \frac{e}{c} \left(\frac{\hbar}{4mc} \vec{\sigma} \times \vec{E} \right) \cdot \vec{p} \right\}$$

and identify $\vec{A}_{so} \equiv \frac{\hbar}{4mc} \vec{\sigma} \times \vec{E}$.

The AB flux from a field passing through a ring of radius R is

$$A_\theta = \frac{\Phi}{2\pi R}$$

If we want an electric field which decays in the same manner we can generate it with a charged wire. This will affect different spin states in the opposite direction.

Where can such electric field arise? It is natural to assume that there will be an abundance of positive charge around the ions giving an effective negative charge between them

(drawing of graphene with charge distribution)

This effect can be introduced by adding the following term to the Hamiltonian

$$i\lambda_R \sum_{ij} c_i^\dagger \left(\vec{s} \cdot (\vec{d}_i \times \vec{d}_j) \right) c_j$$

With $\vec{d}_{i(j)}$ are in-plane vectors connecting the next nearest neighbor i, j through a common neighbor. Each band produces two edge modes for the two spin states. These are protected from scattering off each other from time reversal symmetry (there is no magnetic field in the problem). However, such states from different bands can scatter off each other which usually destroys the conductance which can be produced by them.