

THEORETICAL IMPLICATIONS OF THE NEW PARTICLES*

Haim Harari

Weizmann Institute of Science
Rehovot, Israel

and

Stanford Linear Accelerator Center, Stanford University
Stanford, California

I. INTRODUCTION

It all started nine months ago, but it seems like nine years. The number of exciting new discoveries and the amount of new experimental information are incredible, and we are justified in turning this symposium into a celebration of physics. The main heroes of our celebration are, of course, our experimental colleagues. First - the MIT-Brookhaven group¹⁻² and the SLAC-LBL team³⁻¹⁰, and then - the many other groups, including the DASP collaboration at DESY¹¹⁻¹² and the HPW collaboration at the Fermilab,¹³⁻¹⁴ all of which have changed the face of particle physics during the last nine months.

If the experimentalists were successful, the theorists were doubly successful. They predicted that $R = \sigma(e^+e^- \rightarrow \text{hadrons}) / \sigma(e^+e^- \rightarrow \mu^+\mu^-)$ would be constant, and it turned out to be constant twice⁸ (figure 1)... The clear threshold⁵ in R signals the beginning of a new physics as much as the new particles do, and the question which accompanied us for the last nine months was: What are the features of this "new physics"? Does it represent one new quark (charm) or several? Does it represent heavy leptons or other non-hadronic particles? Does it represent an observable color degree of freedom? Is it something entirely new and unexpected?

We believe that some of these questions are now answered while others are still open, but very close to being settled. We must emphasize, however, that the rate of events enables us to present in this report, only a summary of our understanding of the new particles, as of the afternoon of August 22. Our very recent experiences prevent us from estimating the expected lifetime of the opinions, evaluations and conclusions presented here.

*Supported in part by the U.S. energy research and development administration and by the U.S.-Israel Binational Science Foundation.

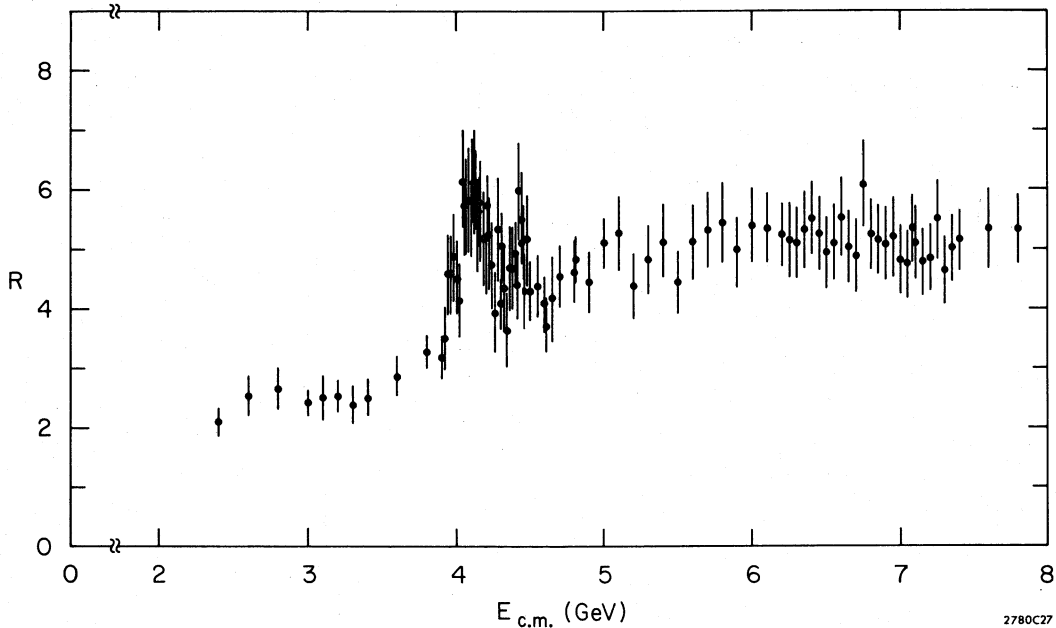

Figure 1: $R = \sigma(e^+e^- \rightarrow \text{hadrons}) / \sigma(e^+e^- \rightarrow \mu^+\mu^-)$ as a function of energy.

II. THE EXPERIMENTAL ψ -SPECTRUM ON AUGUST 22, 1975

A summary of the known spectrum of the " ψ -family" is presented in figure 2. of the eight possible states in this figure three were reported yesterday for the first time^{8,10,12}, and two have been with us for a month or two^{11,6}. Some properties of the new particles are summarized in table I.

Several points should be noted:

- (i) No direct hadronic decay of ψ' have yet been identified⁹. We return to this in section XI.
- (ii) No decay modes of $\psi''(4100)$ or the new $\psi'''(4450)$ have yet been identified. $\psi''(4100)$ may even contain some internal structure. We know, however, that the decay modes of $\psi''(4100)$ do not include a significant number of $\psi(3100)$ in the final state.
- (iii) The $\gamma\gamma$ and $\bar{p}p$ decay modes of $\chi(2800)$ are more or less comparable¹². Since $\bar{p}p$ is, presumably, only one among many hadronic decay modes, the $\chi \rightarrow \gamma\gamma$ branching ratio is probably very small (\leq a few percent).
- (iv) $\chi(3410)$ is not a pseudoscalar meson, if its $\pi\pi$ or $K\bar{K}$ decay modes^{6,10} are confirmed. This is a crucial point which destroys many theoretical models,

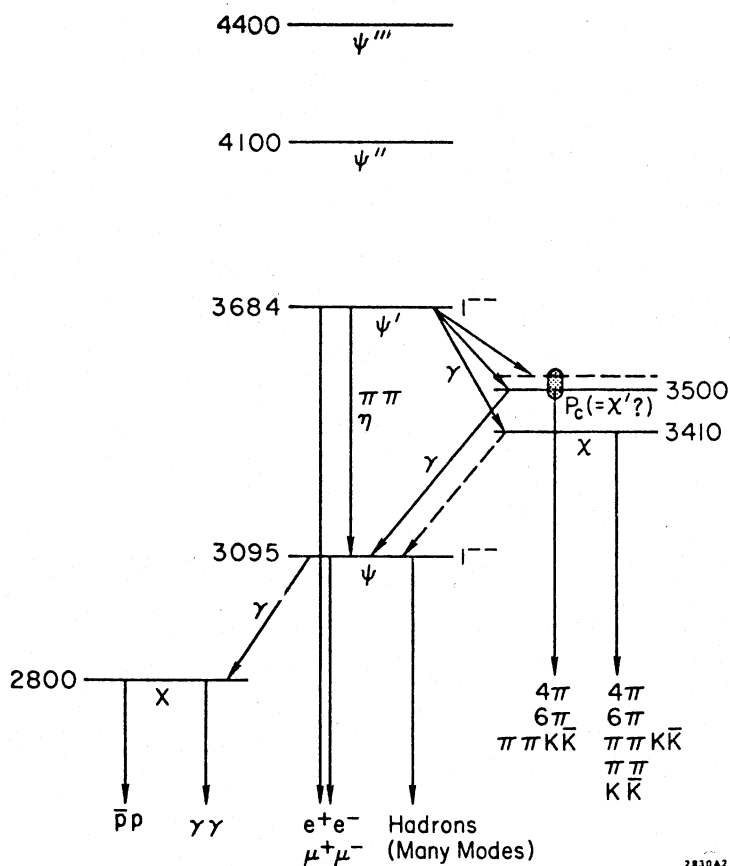

Figure 2: Present status of the ψ -spectrum.

and it is important to verify it experimentally.

(v) It is not clear how many states exist in the 3500-3550 MeV range, but the SLAC-LBL collaboration feels that at least two states are present¹⁰.

(vi) The transition $\chi(3410) \rightarrow \gamma\psi$ has not been observed at SPEAR. The DASP group has two events¹².

(vii) The branching ratios for $(\gamma\psi)/(\text{hadrons})$ are not yet determined for the various P_c and χ states, but it seems that these ratios may be substantially different for the different states in this region¹⁰.

We will return to these and other points in section X.

Name	Mass	Width	J^P	C	Decay Modes
$\psi=J$	3095	70 keV	1^-	-	e^+e^- , $\mu^+\mu^-$, hadrons (via γ) Many hadronic modes ($G=-1$, $I=0$) $\gamma+x(2800)$
ψ'	3684	225 keV	1^-	-	e^+e^- , $\mu^+\mu^-$, Hadrons (via γ) $\gamma+P_c(3510)$, $\gamma+\chi(3410)$ $\pi\pi\psi$, $\eta\psi$
ψ''	~ 4100	100-200 MeV	1^-	-	?
ψ'''	~ 4450	50-80 MeV	1^-	-	?
$x(=\eta_c?)$	~ 2800	?	?	+	$\gamma\gamma$, $p\bar{p}$
χ	3410	narrow	$P=(-1)^J$	+	4π , 6π , $\pi\pi K\bar{K}$, $\pi\pi$ or $K\bar{K}$ $\gamma\psi(?)$
$P_c(=\chi?)$	3510(or 3260?)	narrow	?	+	$\gamma\psi$
$\chi'(=P_c?)$	3530	wide or two narrow states?	?	+	4π , 6π , $\pi\pi K\bar{K}$ $\gamma\psi(?)$

Table I: A short particle data table for the ψ -family, August 22, 1975III. ARE THE ψ -PARTICLES HADRONS?

We believe that the ψ -particles are hadrons. More precisely: they participate in interactions which are stronger than electromagnetism. This means that they are either hadrons with ordinary strong interactions or that they possess some entirely new interaction which is stronger than electromagnetism. We know of no reason to believe that the latter possibility is correct.

The indications for the hadronic nature of the ψ -states are the following:

(i) $\psi''(4100)$ as well as $\psi'''(4450)$ have normal hadronic widths of 50-200 MeV^{5,8}. They are certainly hadrons (but perhaps they are not related to ψ and ψ' ?).

- (ii) The new $C = +1$ states^{11,12,6,10} ($P_c, \chi, \chi(2800), \dots$) indicate that we have a full spectroscopy of different J^{PC} states, rather than one or two more fundamental vector mesons (but perhaps this spectroscopy does not relate to the strong interactions?)
- (iii) The direct hadronic decays of $\psi(3100)$ seem to conserve isospin and G-parity⁹. Among the known interactions, only the strong interactions respect these quantum numbers. (But perhaps some new interaction respects them too?)
- (iv) The measured $\sigma(\gamma p \rightarrow \psi p)$ ^{15,16} together with vector dominance give an elastic ψp cross section which is larger than $\gamma p \rightarrow \gamma p$ by one or two orders of magnitude. Similarly, if we further assume that $\psi p \rightarrow \psi p$ is diffractive at present energies, we find $\sigma_{\text{tot}}(\psi p) \sim 1$ mb. (However, these arguments use vector dominance, and if ψ is not a hadron, vector dominance is not applicable).
- (v) If ψ is a bound state of a fermion and an antifermion, the strength of their binding determines the $\psi \rightarrow e^+ e^-$ decay rate. The observed values of $\Gamma(\psi \rightarrow e^+ e^-)$, $\Gamma(\psi' \rightarrow e^+ e^-)$, $\Gamma(\psi'' \rightarrow e^+ e^-)$ are comparable to each other and to the ρ, ω, ϕ leptonic decay rates. The binding of the fermion-antifermion pair must be significantly stronger than an electromagnetic binding. (But perhaps the ψ -states are not fermion-antifermion bound states?)

Each of these arguments by itself is not conclusive. For each one of them there are "ifs" and "buts"¹⁷, some of which we have mentioned above, parenthetically. However, the overall trend is clear. The ψ -particles seem to have fairly normal hadronic properties and the suppression of their direct interactions with other, ordinary, hadrons can be qualitatively accounted for by the Zweig-Iizuka rule¹⁸ to which we return in sections VII and VIII.

IV. THE ψ -STATES AND THE THRESHOLD IN R

The ψ particles^{1,3,4} are found in the same reaction and the same energy range as the new threshold⁵ which changes R from 2.5 to 5 (figure 1). The integrated areas under the ψ, ψ', ψ'' resonances are comparable to each other (within factor 3). These areas, if "smeared" or averaged over an energy range of 1 or 2 GeV (the ψ level spacing) would yield an average cross section of 10-15 nb. The threshold in R corresponds to an increment of a similar number

of nanobarns at $\sqrt{s} \sim 4-5$ GeV . Consequently, it is reasonable to guess¹⁹ that the ψ -states are related to the "step" in R, and that they may be bound states of the same physical system whose continuum is manifested by the new threshold.

We therefore conclude that at least a substantial part of the increase in R is directly related to the ψ -particles. Whether the entire increase in R is due to the same source we do not know, and we will emphasize later that it may actually reflect two different thresholds.

V. DOES ψ POSSESS A NEW QUANTUM NUMBER? IS IT "COLORED"?

Why is $\psi(3100)$ so narrow?

The simplest explanation would be that ψ possess a new quantum number which is not shared by any of the previously discovered hadrons. The conservation law associated with the new quantum number would then prevent all hadronic decays of ψ .

The direct $\gamma \leftrightarrow \psi$ coupling is comparable to $\gamma \leftrightarrow \rho$. Consequently, the electromagnetic current must have a substantial piece which carries the new quantum number. As long as charge conjugation is a good symmetry, a quantum number carried by the photon cannot be additive (like charge, strangeness, baryon number, etc.). It must be either multiplicative (like Parity, Charge Conjugation etc.) or vector-like (like Isospin, Spin, SU(3), color, etc.). Regardless of the explicit choice of the new non-additive quantum number, the following "script" emerges in such a model:

- (a) ψ is the lowest lying vector meson possessing the new quantum number. It has no direct decays to ordinary hadrons.
- (b) ψ' could decay strongly into $\psi\pi\pi$, $\psi\eta$. Its narrow width must be due to an entirely different mechanism (such as the Zweig-Iizuka rule¹⁸).
- (c) The threshold in R represents the production of many wide, overlapping new excited states with the new quantum number. Their dominant decay modes are into the lowest lying states possessing the new quantum number, such as ψ or its pseudoscalar neighbour.
- (d) ψ can "lose" its new quantum number by radiating a photon. Hence, the dominant ψ decay modes should be: $\psi \rightarrow \gamma + \text{hadrons}$.

The many versions²⁰ of the Han-Nambu²¹ color model for the ψ -particles follow the "script" outlined above. In addition, they have other common features. Both ψ and ψ' belong to color octets. However, the color-conserving strong decays $\psi' \rightarrow \psi\pi\pi$, $\psi' \rightarrow \psi\eta$, are suppressed by the Zweig-Iizuka rule because the ψ and ψ' (in analogy to ω and ϕ) are made out of different types of quarks. This leads us to expect pseudoscalar neighbours for ψ and for ψ' but there is no need for several states between ψ and ψ' . We also expect charged ψ_ρ -particles around $\psi(3100)$ with transitions such as $\psi' \rightarrow \pi^\pm + \psi_\rho^\mp$ etc.

We believe that the color scheme, as well as all other models assigning a new quantum number to the ψ -particles, are in serious disagreement with the data. All such models suffer from the following difficulties:

(i) Many direct hadronic decay of $\psi(3100)$ have been observed⁹. They include $\pi\rho, \pi\pi\omega, K\bar{K}^*, p\bar{p}, \Lambda\bar{\Lambda}, K\bar{K}\pi\pi, \bar{p}p\pi\pi$, etc. In all pionic ψ -decays, whenever a π^0 can be distinguished from a γ , it proves to be a π^0 . In particular $\Gamma(\psi \rightarrow \pi^+ \pi^- \pi^0) > \Gamma(\psi \rightarrow \pi^+ \pi^- \gamma)$.

(ii) In e^+e^- collisions above $W \sim 4$ GeV, very few (if any) ψ -particles are observed in the final state. This contradicts the basic notion that all strong decays of all excited states possessing the new quantum number should show a ψ or another low lying member of the same "family".

(iii) The rates for $\psi \rightarrow \gamma + \text{hadrons}$ are certainly much smaller than expected for full strength ordinary radiative decays. For instance $\Gamma(\phi \rightarrow \eta\gamma) \sim 100$ keV while¹² $\Gamma(\psi \rightarrow \eta\gamma) \sim 100$ eV, $\Gamma(\psi \rightarrow \eta'\gamma) \sim 1$ keV. It is clear that ψ radiative decays are strongly suppressed.

(iv) The existence of several $C = +1$ states^{11,6} between ψ and ψ' , and the clear indication that at least $\chi(3410)$ is not a pseudoscalar meson^{6,10}, is very hard to digest in such models which expect only $J^P = 0^-$ states between ψ and ψ' .

Color models suffer from several other difficulties such as the absence of charged ψ_ρ^\pm in ψ' decays, and the lack of any explanation for the two-muon events in neutrino scattering.

We conclude that in spite of the ingenuity that went into some of these models, their gross features are incompatible with the experimental observations.

The direct hadronic decays of ψ , the lack of important radiative decays and the absence of ψ 's in high energy e^+e^- final states lead us to conclude that the ψ -particles do not possess a new non-additive quantum number such as the Han-Nambu version of color.

VI. THE ψ -PARTICLES AS COLORLESS BOUND STATES OF HEAVY QUARKS

The rejection of the possibility that the ψ -particles are colored, returns us to the conventional theoretical framework of hadron physics according to which:

- (i) All hadrons are made out of quarks.
- (ii) All quarks are color triplets.
- (iii) The electromagnetic current does not carry color.
- (iv) All hadrons are color singlets.

Our set of quarks includes three "old" "light" quarks-u,d,s, and one or more "new" "heavy" quarks. We will use the collective notation q for any of the "old" quarks while the "new" quark or quarks will be denoted by Q .

We expect three types of mesons:

- (i) Ordinary mesons are $q\bar{q}$ states.
- (ii) We assume that the entire ψ -spectrum corresponds to $Q\bar{Q}$ states.
- (iii) An additional family of mesons should be formed by $q\bar{Q}$ and $Q\bar{q}$ states.

These are the ("charmed") D-mesons which are predicted in any such model.

The important dynamical ingredient which is responsible, in such a theory, for the narrow width of the ψ , is the Zweig-Iizuka (ZI) rule¹⁸. Both $\psi \rightarrow \text{hadrons}$ and $\psi' \rightarrow \psi\pi\pi$, $\psi' \rightarrow \text{hadrons}$ decays are suppressed by this rule and the narrow widths of both ψ and ψ' are "explained" by the same mechanism. It is significant that this mechanism was not invented for the purpose of "explaining" the ψ -width. It is a natural consequence of dual models (such as the "string model") and it has been in use for ten years for the purpose of explaining the production and decay properties of the ϕ -meson.

The quantitative aspects and the theoretical foundations of the ZI-rule are far from clear. The fact that it works much better for ψ than for ϕ was predicted by Appelquist and Politzer²² before the ψ was discovered, but

the magnitude of the suppression remains to be understood. The asymptotically free gauge theory of colored quarks and gluons predicts that ZI-forbidden transitions are weaker for heavier quarks. It is extremely crucial to test this and to understand this better. We return to this issue in section VIII.

VII. QUALITATIVE FEATURES OF PROCESSES INVOLVING ψ -PARTICLES

We now review several classes of processes involving the new mesons, and discuss some of their qualitative features. We will use the symbols Ψ, D, M for $Q\bar{Q}, Q\bar{q}$ or $q\bar{Q}, q\bar{q}$ mesons, respectively.

(A) $\Psi \rightarrow MM$ (figure 3a)

Such processes are suppressed by the ZI-rule. The total hadronic widths of ψ and ψ' are, of course, very small. It is important to note, however, that the much wider $\psi''(4100)$ is unlikely to decay into M-mesons for the same reason. Its branching ratio into all ordinary hadronic modes would presumably be $10^{-3}-10^{-4}$, and we cannot hope to determine its isospin or G-parity by investigating $\psi'' \rightarrow$ pions.

(B) $\Psi \rightarrow \Psi M$ (figure 3b)

Such processes are also suppressed by the ZI-rule, although in this case the total energy transferred by the gluons is much smaller, and the degree of suppression may be somewhat less spectacular. The decays $\psi' \rightarrow \psi\pi\pi$ and $\psi' \rightarrow \psi\eta$ are indeed suppressed. It would be interesting to search for $\psi' \rightarrow \omega + x(2800)$, but its strength is guaranteed to be small by the total ψ' -width. All ψ'' decays involving ψ, ψ', χ, P_c etc. in the final state are also suppressed. Consequently, we should not find many ψ 's in the final state around 4.1 GeV. This is confirmed by the data.

(C) $\Psi \rightarrow D\bar{D}$ (figure 3c)

These are unsuppressed, regular, strong decays. They presumably account for almost all of $\psi''(4100)$ and $\psi'''(4450)$ decays. The lower-lying states $\psi(3100), \psi'(3700), P_c, \chi, x(2800)$, cannot decay into $D\bar{D}$ because of energy conservation.

(D) $\Psi \rightarrow \gamma\Psi$ (figure 3d)

These are ordinary radiative decays, and their rates should be of order α . Experimentally, the partial widths for $\psi' \rightarrow \gamma\chi, \psi' \rightarrow \gamma P_c, \psi \rightarrow \gamma x(2800)$, seem to be

of the order of 1-10 keV^{6,10,11,12}. This is substantially smaller than decays of the type $M \rightarrow \gamma M$ (e.g. $\omega \rightarrow \pi\gamma$, $\phi \rightarrow \eta\gamma$, $\Delta^+ \rightarrow p\gamma$, etc.). No convincing explanation has been offered for this fact, so far.

(E) $\Psi \rightarrow \gamma M$ (figure 3e)

These radiative decays are suppressed by the ZI-rule. They should be smaller than $\Psi \rightarrow \gamma \Psi$ transitions because of this suppression, and smaller than $\Psi \rightarrow MM$ decays, by a factor α . The only observed decays of this class, so far, are¹² $\Gamma(\Psi \rightarrow \eta\gamma) \sim 100$ eV; $\Gamma(\Psi \rightarrow \eta'\gamma) \sim 1$ keV.

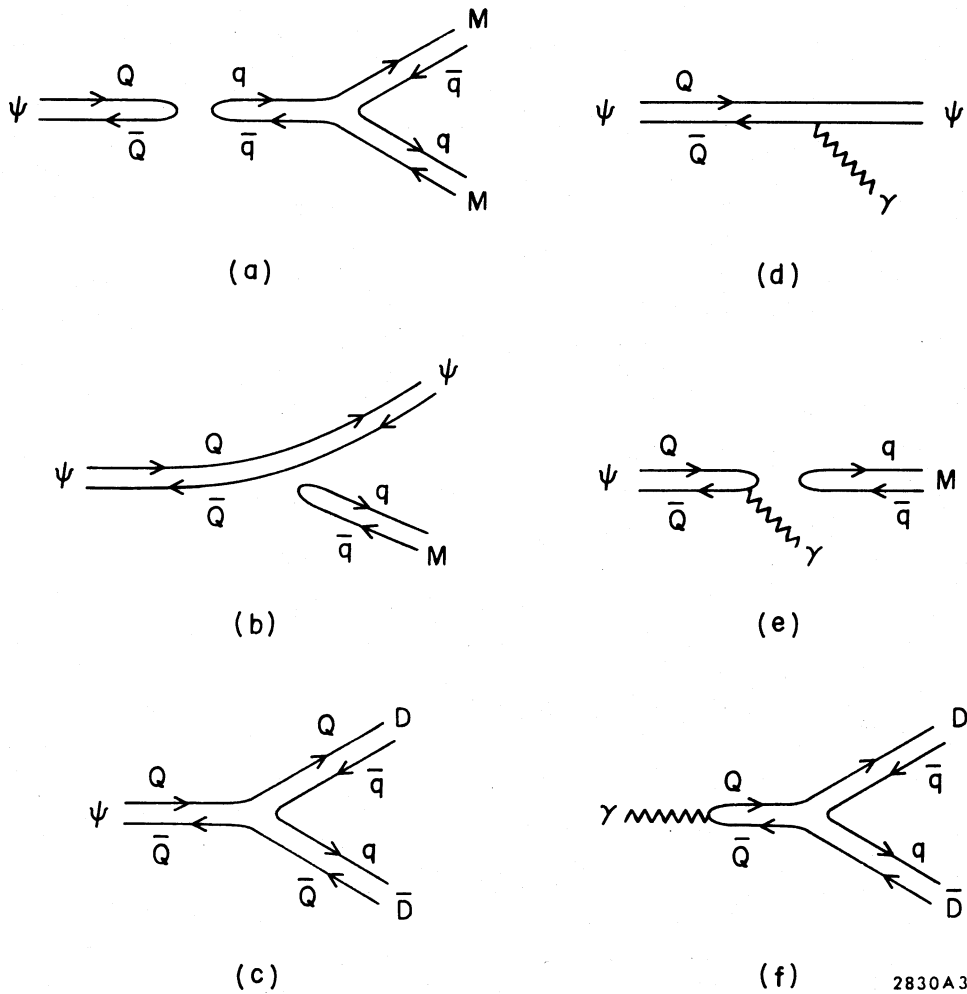

Figure 3: Quark diagrams for reactions involving M, D and Ψ mesons.

(F) $e^+e^- \rightarrow \Psi$ (figure 3f)

Whenever a $Q\bar{Q}$ pair is produced in e^+e^- collision, an excited Ψ state is created. Its disintegration follows the rules outlined in (A), (B), (C) above. Consequently, in almost all cases a $D\bar{D}$ pair (possibly $D^* \bar{D}^{**}$, etc.) will emerge, while ψ particles in the final state should be (and are) extremely rare.

The emerging overall picture is that the ZI-rule accounts for several features which are otherwise very mysterious, but that our quantitative understanding of the various rates, especially those of radiative decays, is totally inadequate. It is extremely important to perform many more experimental tests of the ZI-rule, and to find out if its success indeed depends on the energy transmitted by the gluons and on the number of gluons involved. We therefore turn now to a few suggested experiments along these lines.

VIII. HOW TO TEST THE ZWEIG-IIZUKA RULE?

Several interesting tests of the ZI-rule and its theoretical origin, are the following:

(i) The absolute width of $C = +1$ states of the Ψ -family will provide us with some insight into the ZI-rule. If $x(2800)$ is indeed the pseudoscalar analogue of $\psi(3100)$, it can decay into hadrons via a two-gluon state rather than a three-gluon state²³ (figure 4a). If the gluon couplings are small, $x(2800)$ should have a width of the order of 1-5 MeV. A measurement of the absolute width is, in principle, possible, using the Primakoff process: $\gamma + \text{Nucleus} \rightarrow x(2800) + \text{anything}$ via one-photon exchange. This seems like a very difficult experiment, especially in view of the apparent small branching ratio¹² of $x(2800)$ into easily detectable modes ($p\bar{p}$ or $\gamma\gamma$). Other $C = +1$ states such as χ and P_c states can also decay via two gluons but their total width is further suppressed by the $l=1$ angular momentum of their $Q\bar{Q}$ pair in the nonrelativistic Charmonium scheme²³. It is not clear that we would be able to disentangle the different suppression factors in that case.

(ii) If $x(2800)$ is a $J^{PC} = 0^{-+}$ state, the decay $\psi' \rightarrow \omega + x$ must exist. Its strength should teach us something about the ZI-rule. The transition involves three gluons as opposed to two gluons for $\psi' \rightarrow \psi\pi\pi$, $\psi' \rightarrow \psi\eta$ (figure 4b). The

total energy carried by these gluons is, however, substantially smaller than in $\Psi \rightarrow MM$ decays. In fact, the processes discussed so far in this section should provide us with some information on the importance of both the number and the energy of the gluons. This is summarized in table II.

	3 gluons	2 gluons
$E(\text{gluons}) \sim 3 \text{ GeV}$	$\psi \rightarrow \text{hadrons}$	$x(2800) \rightarrow \text{hadrons}$
$E(\text{gluons}) \sim 0.5-1 \text{ GeV}$	$\psi' \rightarrow \omega x(2800), \phi \rightarrow 3\pi$	$\psi' \rightarrow \psi\pi\pi, \psi' \rightarrow \psi\eta$

Table II: Processes suppressed by the ZI rule, involving different gluon numbers and energies.

(iii) Since ψ' is now found, it is about time that ϕ' be found. The ϕ' which is associated with $\rho'(1550)$, is expected somewhere around 1800 MeV. Its dominant decay modes should be into $K\bar{K}, K\bar{K}\pi, K\bar{K}\pi\pi$, etc. The decays $\phi' \rightarrow \text{pions}$ and $\phi' \rightarrow \phi\pi\pi$ are ZI-suppressed. $\phi' \rightarrow \phi\eta$ is not suppressed. If the gluon energy is relevant, we expect $\Gamma(\phi' \rightarrow \text{pions}) < \Gamma(\phi \rightarrow \text{pions})$. We expect also:

$\Gamma(\phi' \rightarrow \phi\eta) \gg \Gamma(\phi' \rightarrow \phi\pi\pi)$. All of these modes are detectable once ϕ' is discovered. It can most easily be found in e^+e^- experiments or, possibly, in photoproduction.

(iv) The decay $\psi \rightarrow \phi\pi\pi$ is predicted to be suppressed even more than $\psi \rightarrow \omega\pi\pi$ (figure 4c). In theories with gluons, $\psi \rightarrow \phi\pi\pi$ involves four gluons while $\psi \rightarrow \omega\pi\pi$ has only three. The fourth gluon connects the ϕ to the $\pi\pi$ system and does not carry too much energy, and the degree of extra suppression is not expected to be spectacular. We now have a preliminary experimental value⁹: $\Gamma(\psi \rightarrow \phi\pi\pi) / \Gamma(\psi \rightarrow \omega\pi\pi) \sim 0.2 \pm 0.1$. This should provide us with more constraints on the ZI-rule. Note that $\psi \rightarrow \phi\eta$ is not doubly suppressed and should have a larger matrix element than $\psi \rightarrow \phi\pi\pi$.

(v) There are many ZI inequalities for ϕ -production. We expect $\sigma(pp \rightarrow pp\phi K\bar{K}) > \sigma(pp \rightarrow pp\phi\pi\pi)$ etc. This should be investigated in detail. The implications for ψ and D production are, of course, clear. We expect $\sigma(pp \rightarrow \psi + \text{anything})$ to include many $D\bar{D}$ pairs²⁴.

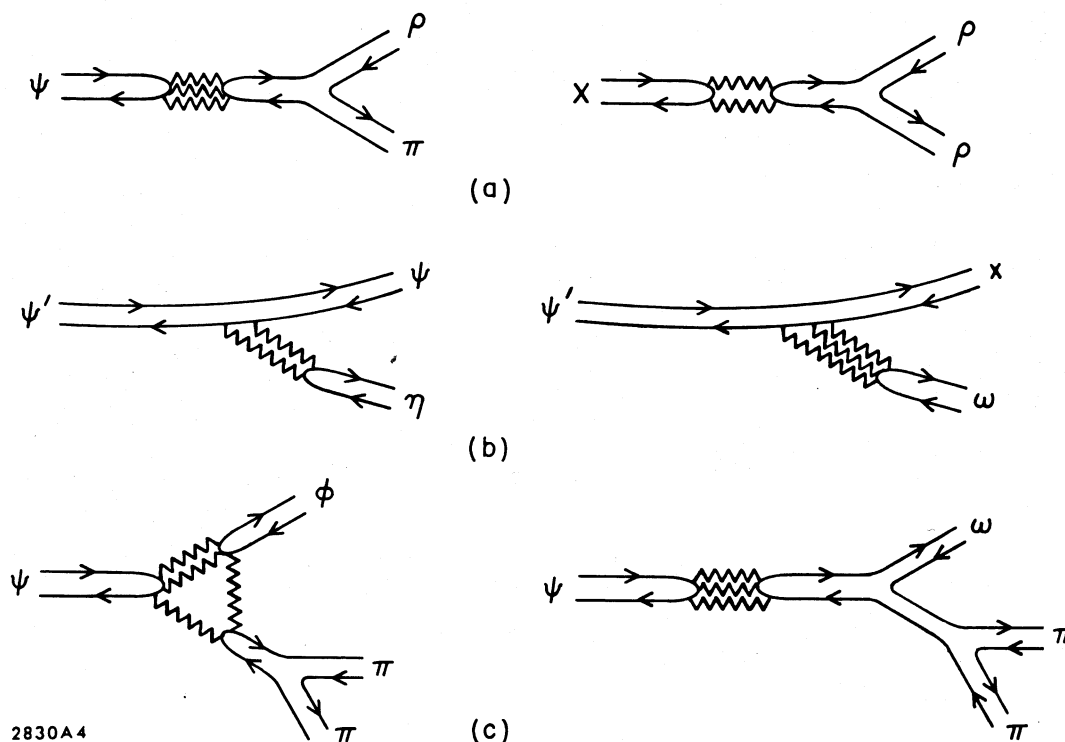

Figure 4: Quark diagrams for processes suppressed by the ZI-rule.

(vi) Processes such as $\psi p \rightarrow \pi\pi\pi p$ or $\psi p \rightarrow \psi\pi\pi p$ are suppressed by the ZI-rule. The dominant inelastic channels in ψp scattering are of the type $\psi p \rightarrow D\bar{D}\pi\pi p$ ²⁴. Since the production of such final states is probably much smaller than, say, $\pi p \rightarrow \pi\pi\pi p$, we expect $\sigma_{\text{tot}}(\psi p) \ll \sigma_{\text{tot}}(\pi p)$. Moreover, $\sigma_{\text{tot}}(\psi p)$ should show a striking threshold effect²⁴ at the $D\bar{D}$ threshold ($\sqrt{s} \sim 5$ GeV). ψp scattering experiments are, of course, impossible, but ψ -photoproduction should reflect some of these features. We especially expect a clear threshold in $\gamma p \rightarrow \psi p$ around $\sqrt{s} \sim 5$ GeV or $p_{\gamma} \sim 13$ GeV. Present data^{15,16,25} are consistent with, but do not prove, the existence of such a threshold. These and other quantitative investigations of the ZI rule are absolutely crucial for our understanding of the new particles.

IX. WHY DO WE NEED NEW QUARKS?

The conventional V-A theory of the weak interactions, and the SU(2) "weak isospin" of a Weinberg-Salam gauge theory provide us with two doublets of left handed leptons:

$$\begin{pmatrix} \nu_e \\ e^- \end{pmatrix} \quad \begin{pmatrix} \nu_\mu \\ \mu^- \end{pmatrix}$$

Cabibbo's theory of the hadronic weak interactions contains a "weak isospin" doublet and a singlet of left handed quarks:

$$\begin{pmatrix} u \\ d' \end{pmatrix} \quad (s')$$

where

$$d' = d \cos\theta_c + s \sin\theta_c$$

$$s' = -d \sin\theta_c + s \cos\theta_c$$

It is clear that such a theory shows no resemblance between leptons and quarks. Furthermore, the neutral weak-isovector current includes a term

$$\bar{d}'(1 + \gamma_5)\gamma_\mu d'$$

which contains a neutral $|\Delta S| = 1$ component of strength $G \cos\theta_c \sin\theta_c$. Such a term would induce a large $K_L^0 \rightarrow \mu^+ \mu^-$ decay and a large $K_S^0 - K_L^0$ mass difference. The s' -quark does not participate in any charged weak transition in such a theory, and the famous triangle anomalies²⁶ (figure 5) are not cancelled. The cancellation condition for such anomalies in a pure V-A theory is²⁷

$$\sum_{\text{all fermions}} Q_i = 0$$

This relation is, of course, not obeyed in a theory of four leptons and three quarks.

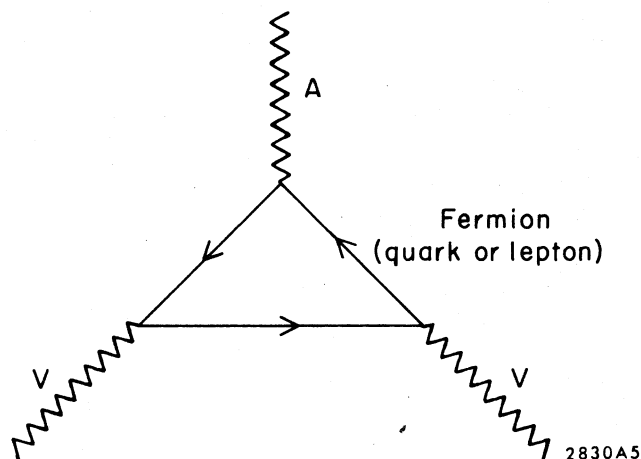

Figure 5: The triangle anomaly graph.

All of this unpleasantness is immediately rectified if we follow the brilliant suggestion of Glashow Illiopoulos and Maiani²⁸, and introduce a fourth charmed quark c with $Q = +\frac{2}{3}$. The four left handed quarks now form two weak-isodoublets:

$$\begin{pmatrix} u \\ d' \end{pmatrix} \quad \begin{pmatrix} c \\ s' \end{pmatrix}$$

The symmetry between the four leptons and four quarks is obvious. The V-A neutral current includes a term:

$$d'\bar{d}' + s'\bar{s}' = d\bar{d} + s\bar{s}$$

and is, therefore, diagonal in the quark states and conserves all additive quantum numbers, including Strangeness and Charm. The $K_L \rightarrow \mu^+ \mu^-$ and $K_L - K_S$ transitions are very small. The s' -quark is now a full participant in charged weak transitions. In fact, all weak decays of charmed particles

involve a $c \rightarrow s'$ transition. Since s' is mostly (95%) a strange quark, most weak decays of charmed particles involve strange particles. The leptons have:

$$\sum_{\text{leptons}} Q_i = -2$$

While the four tricolored quarks have:

$$\sum_{\text{quarks}} Q_i = 3 \left(\frac{2}{3} - \frac{1}{3} + \frac{2}{3} - \frac{1}{3} \right) = +2$$

Hence:

$$\sum_{\text{fermions}} Q_i = 0$$

and the anomalies cancel. It is remarkable how much you can get, by introducing only one new quark! It might be even more remarkable if this quark is found and if it has all the predicted properties, especially the dominant weak decay into strange particles.

The model including four leptons and four quarks is the minimal extension of the previously known set of particles (four leptons and three quarks), which is consistent with the absence of neutral $|\Delta S| = 1$ currents and anomalies. However, we may extend the scheme by adding more weak-isodoublets of leptons and quarks. The next simple extension could be to introduce two new leptons for a total of six:

$$\begin{pmatrix} \nu_e \\ e^- \end{pmatrix} \quad \begin{pmatrix} \nu_\mu \\ \mu^- \end{pmatrix} \quad \begin{pmatrix} \nu_L \\ L^- \end{pmatrix}$$

and two extra quarks for a total of six²⁹:

$$\begin{pmatrix} u \\ d' \end{pmatrix} \quad \begin{pmatrix} c \\ s' \end{pmatrix} \quad \begin{pmatrix} t \\ b \end{pmatrix}$$

Here t and b (for top, bottom) must have $Q = +\frac{2}{3}$, $-\frac{1}{3}$ respectively, in

order to preserve all the required features. The c and t quarks may be mixed by a Cabibbo-like angle ϕ :

$$c' = c \cos\phi + t \sin\phi$$

$$t' = -c \sin\phi + t \cos\phi$$

and the weak-isodoublets are then:

$$\begin{pmatrix} u \\ d \end{pmatrix} \quad \begin{pmatrix} c' \\ s' \end{pmatrix} \quad \begin{pmatrix} t' \\ b \end{pmatrix}$$

One quark can always be chosen to be an eigenstate of the strong interaction symmetry and the "weak-isospin". We choose it to be u. The b-quark may, in principle, mix with d' and s' but the fact that independent measurements of $\sin\theta_c$ and $\cos\theta_c$ give $\sin^2\theta_c + \cos^2\theta_c = 1$ means that b mixes very little, if at all. Hence θ_c and ϕ are the only relevant mixing angles.

Within the V-A theory there is no theoretical reason to increase the number of leptons and quarks to six or more. However, if more than four leptons or more than four quarks are found experimentally, this becomes a necessity within the framework outlined above.

The quark-lepton symmetry, absence of $|\Delta S| = 1$ neutral currents, cancellation of anomalies and dominant strange particle decays of the new quarks are common to any pure V-A model which has an equal number of weak-isodoublets of leptons and quarks.

We therefore conclude that the existence of four left-handed leptons leads us to expect a fourth quark while the possible existence of a fifth and a sixth lepton might imply two more quarks for a total of six. We return to this in section XVI.

X. Ψ -SPECTROSCOPY

The spectroscopy of the Ψ -family should provide us with answers to several important issues such as the number of new types of quarks and the dynamics of the $Q\bar{Q}$ interactions. Until two months ago, when we had only three of the present

eight states of the ψ -family, several options appeared to be equally reasonable:

(a) We have one new (charmed) quark²⁸. ψ is the ground state 1^3S_1 vector meson. ψ' is the first radially excited state²³ 2^3S_1 . ψ'' is the next radial excitation 3^3S_1 . Almost any reasonable potential²³ predicts, in this case, that the lowest lying P-states, 3P_0 , 3P_1 , 3P_2 , are somewhere between ψ and ψ' and can be discovered in the radiative decays of ψ' .

(b) We have several (two or three) new quarks. ψ and ψ' are both ground state vector mesons²⁹, corresponding to different quark combinations (like ρ , ω , ϕ). In such schemes the only $C = +1$ states below ψ' are presumably the $J^{PC} = 0^{-+}$ S-state analogues of ψ and ψ' .

(c) We have several (two or three) new quarks. ψ is a certain combination of such quarks. ψ' is a radial excitation of the same combination³⁰. The other ground-state vector mesons corresponding to other $Q\bar{Q}$ combinations have much smaller couplings to the photon and are not seen. In such models the three P-states are expected between ψ and ψ' .

It is clear that options (a) and (b) are the simplest logical possibilities. (c) was motivated by attempts to reconcile the large increment in R which suggests several new quarks, and the assignment of ψ' as a radially excited state.

The discovery of two or three $C = +1$ states between ψ and ψ' , and the determination of the natural spin-parity of $\chi(3410)$ have made option (b) an unlikely possibility. It seems that the assignment of ψ' as a radially excited state is probably correct.

The choice between the natural option (a) and the somewhat artificial (c) depends on R and several other factors and we will return to it later, in section XVI. The discussion of the observed level structure is, however, common to (a) and (c), and we will pursue it, assuming, for simplicity, that we have only one new (charmed) quark.

The so-called "Charmonium" level scheme is shown in figure 6, as predicted²³ in December 1974 when only ψ and ψ' were known. A comparison with figure 1 shows a dramatic qualitative success. Many questions remain open, however. We discuss here only a few of them.

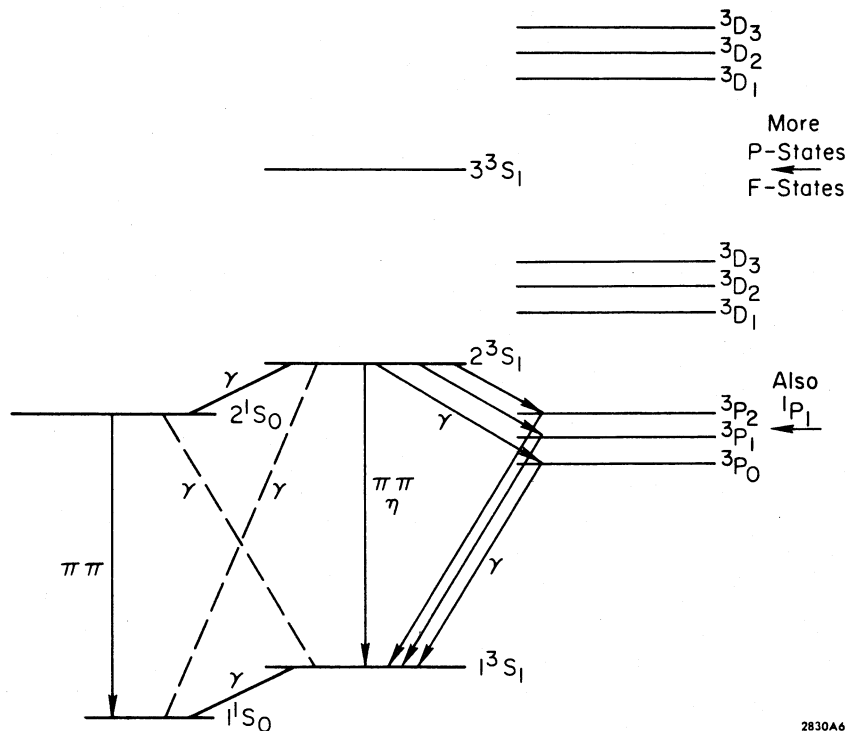

Figure 6: The "Charmonium" level scheme.

(i) The lowest lying 3D_1 state presumably has a very small coupling to the photon. Its wave function allegedly vanishes at the origin and its mixing with the 2^3S_1 state is very small. Consequently, it is not seen as a bump in e^+e^- collisions.

(ii) The next 3D_1 state is above the $D\bar{D}$ threshold. Through charmed meson pairs it mixes more with the 3^3S_1 state. The result is perhaps³¹ the relatively small ψ''' (4450) bump which is then mostly a radially excited D-state, with some 3^3S_1 mixing. The alternative assignment for ψ''' as a 4^3S_1 state is unlikely, since the latter state is expected at a higher mass.

(iii) The absolute magnitude of the partial widths for $\psi' \rightarrow \gamma + \chi$, $\psi' \rightarrow \gamma + P_c$ was predicted²³ to be around 25-125 keV. Experimentally it seems to be 5-10 keV^{6,10,11,12}. This is a serious discrepancy. Attempts to bridge the gap between theory and experiment have left the theory at least a factor 3 away from the experimental numbers³¹. No satisfactory explanation has been offered, so far.

(iv) The mass difference between $\chi(2800)$ and ψ is much too large for any version of the nonrelativistic Charmonium picture. It is possible, however, that the pure $c\bar{c} 0^{-+}$ state is near ψ but that the physical pseudoscalar particle is not a pure $c\bar{c}$ state in the same way that neither η nor η' are pure $s\bar{s}$ states. In this case, however, $\chi(2800)$ production in ordinary hadronic collision should be substantially larger than ψ -production. Moreover, η or η' should have a small $c\bar{c}$ component and ψ and ψ' would have relatively large η and η' decays. The transition $\psi' \rightarrow \psi\eta$ is indeed somewhat large. In any event—either $\chi(2800)$ is not a pure $c\bar{c}$ state, or the nonrelativistic picture is in grave difficulty.

(v) The radially excited pseudoscalar state near ψ' could be one of the observed states around 3500-3550 MeV. We must remember that we altogether expect four $C = +1$ states between ψ and ψ' : three P-states and the 2^3S_0 pseudoscalar state.

(vi) The exact level spacing of the three P-states, if and when they are found, will provide us with a tight test of various properties of the binding potential³². Certain level patterns are unacceptable while others are allowed and may determine the detailed behaviour of the potential.

(vii) The matrix elements for radiative transitions between 2^3S and 1^3S states are predicted to be much smaller than $2^3S_1 \xrightarrow{\gamma} 2^3S_0$ or $1^3S_1 \xrightarrow{\gamma} 1^3S_0$. This follows from the suppressed overlap between the orthogonal 2S and 1S wave functions²³.

(viii) The $(\chi \rightarrow \gamma\psi)/(\chi \rightarrow \text{hadrons})$ branching ratio will also provide insight into the intricate Charmonium picture. Large variations of this ratio for different χ and P_c state seem to exist, and need to be explained.

Independent of the Charmonium picture, the search should continue for charged ψ -like objects (predicted not to exist in the charm scheme) and possible neutral ψ -like states beyond the ones recommended by the charm model. If such states are found, we will be thrown back into two-quark and three-quark schemes for the Ψ -family³⁰.

One experimental puzzle which may or may not be related to such states is the question of the missing ψ' -decays to which we now turn.

XI. THE MISSING DECAYS OF ψ' (3700)

The known decay modes⁹ of ψ' are summarized in table III. Only 65% of the decays are accounted for. The remaining 35% or 80 keV are mysterious. They should include all direct hadronic decays of ψ' .

$\psi' \rightarrow \psi + \text{anything}$	57%	
$\psi \pi^+ \pi^-$		32%
$\psi \pi^0 \pi^0$		16%
$\psi \eta$		~4%
$\psi \gamma \gamma$		~5%
$\psi' \rightarrow \gamma + \text{anything}$	5%	
$e^+ e^-$		1%
$\mu^+ \mu^-$		1%
hadrons		3%
$\psi' \rightarrow \gamma + \chi$ └─ hadrons	few %	
$\psi' \rightarrow \gamma + P_c$ └─ $\gamma + \psi$	included in $\psi' \rightarrow \gamma \gamma \psi$	
total		~65%

Table III: Known decay modes of ψ'

However, no specific hadronic channels have been observed. The upper limits on the partial widths for $\psi' \rightarrow \pi \rho$, $\bar{p} p$, $\pi^+ \pi^- \pi^+ \pi^- \pi^0$ are smaller by factors of 2-3 than the corresponding partial widths for ψ decays. This is consistent with the prediction of the Charmonium scheme²³ which says that direct

hadronic decays of ψ' and ψ should obey the same ratio as their respective leptonic decay ($\psi':\psi \sim 1:2$). In any event, since $\Gamma(\psi \rightarrow \text{hadrons}) \sim 50$ keV, we suspect, on the basis of the present experimental limits, that $\Gamma(\psi' \rightarrow \text{hadrons}) \lesssim 20$ keV. That leaves at least a partial width of 60 keV which is unaccounted for. The "missing" decay modes are not direct hadronic decays, they cannot be reconstructed as four-constraint or one-constraint fits and they cannot be related by isospin or other symmetries to identified decay modes.

These mysterious decays may turn out to be fairly "harmless". This would be the case if they include a substantial $\omega + \chi(2800)$ mode or modes such as $\psi' \rightarrow \pi^0 \gamma \chi(2800)$. However, they may turn out to be crucial and sensational if they represent decays such as $\psi' \rightarrow \pi^\pm \chi^\mp$ or $\psi' \rightarrow \pi^\pm \pi^0 \chi^\mp$. Another possibility is that we have several additional $\psi' \rightarrow \gamma + \chi$ decays with too many χ -states. The last two options would clearly lead to models with several new quarks.

We feel that no theoretical idea for the ψ -spectrum should be accepted as true as long as the missing ψ' -decays are still missing, and we urge our experimental colleagues to try and straighten out this puzzle.

XII. THE ELUSIVE CHARMED MESONS AND THEIR PREDICTED PROPERTIES

Let us assume that the existence of the ψ -particles reveals the existence of only one new quark and that the weak interaction properties of the new quark are then suggested by the "classical" GIM²⁸ Charm scheme. What would be the expected properties of the charmed mesons ("D-mesons") and how would they be reflected by e^+e^- data above $W \sim 4$ GeV?

(i) The mass of the lowest lying D-meson is presumably 1.85-2.0 GeV. This follows from: $m(\psi') < 2m(D) < m(\psi'')$.

(ii) Most decays of D-mesons should include K-mesons in the final state. A reasonable estimate for the number of charmed meson decays containing K-mesons might be 60-80%.

(iii) It is hard to estimate the average multiplicity. However, known mesons around 1600-1700 MeV have average decay multiplicities $\langle n \rangle \sim 3.5-4$ (see e.g. the ρ' and the g mesons). Proton-antiproton annihilation at rest ($M \sim 1.9$ GeV) have $\langle n \rangle \sim 5$. We estimate $\langle n \rangle \sim 4$ for an "average" D-meson. This gives

$\langle n \rangle_{\text{ch}} \sim 2.5-2.7$ per D-meson and $\langle n \rangle_{\text{ch}} \sim 5-5.5$ for each $D\bar{D}$ pair.

(iv) The fraction of the energy carried by charged particles is expected to be as in any hadronic process. However, if the abundant K-mesons are treated as pions, the apparent ratio $E_{\text{ch}}/E_{\text{tot}}$ should be smaller than normal. The $E_{\text{ch}}/E_{\text{tot}}$ ratios measured at SPEAR assume that all charged tracks are pions⁸. Consequently, we would expect it to decline above the $D\bar{D}$ threshold.

(v) The inclusive spectrum for ordinary hadrons coming out of D or \bar{D} decays at SPEAR should be mostly confined²⁹ to $x < 0.5$.

(vi) Two body decays such as $(K\pi)$ are expected to be fairly rare, since $\langle n \rangle \sim 4$. The branching ratio of $D \rightarrow K\pi$ is probably, at most, a few percent.

(vii) The pure leptonic $e\nu, \mu\nu$ decays are very small³³. If the lowest lying D is a pseudoscalar, and we have a V-A transition, $\Gamma(D \rightarrow \mu\nu) \gg \Gamma(D \rightarrow e\nu)$.

(viii) The contribution of $D\bar{D}$ pairs to R is asymptotically $\frac{4}{3}$. It is possible that at present energies it is 10-20% higher, i.e. $\Delta R \sim 1.5$.

This is the type of list that one would make if one had not seen the SPEAR data above $W \sim 4$ GeV. It is a reasonable, unbiased list of predictions of the Charm scheme.

XIII. COULD ALL OF THE "NEW PHYSICS" BE DUE TO CHARM?

In order to study the experimental features of the "new physics", we have to compare the data for e^+e^- collisions below and above the new threshold. Figure 7 shows some of the relevant data⁸. Comparing the results to the expectations outlined in the previous section, we learn that:

(i) The $W \sim 4$ GeV threshold is consistent with the production of pairs of 2 GeV particles.

(ii) The percentage of events containing K-meson does not change substantially, when we cross the new threshold. This is a very serious difficulty for charm (see, however, section XV).

(iii) The average charged multiplicity above $W \sim 4$ GeV is $\langle n \rangle_{\text{ch}} \sim 4$ rather than the expected 5-5.5. This means that each of new (pair-produced) particles decays on the average into two charged particles, and probably one or two additional neutrals.

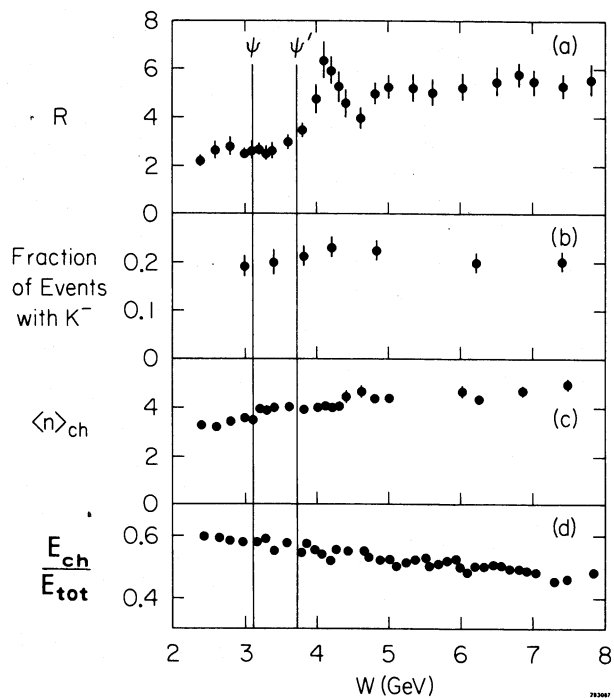

Fig. 7--R, fraction of events with K⁻, <n>_{ch}, and E_{ch}/E_{tot} as a function of W.

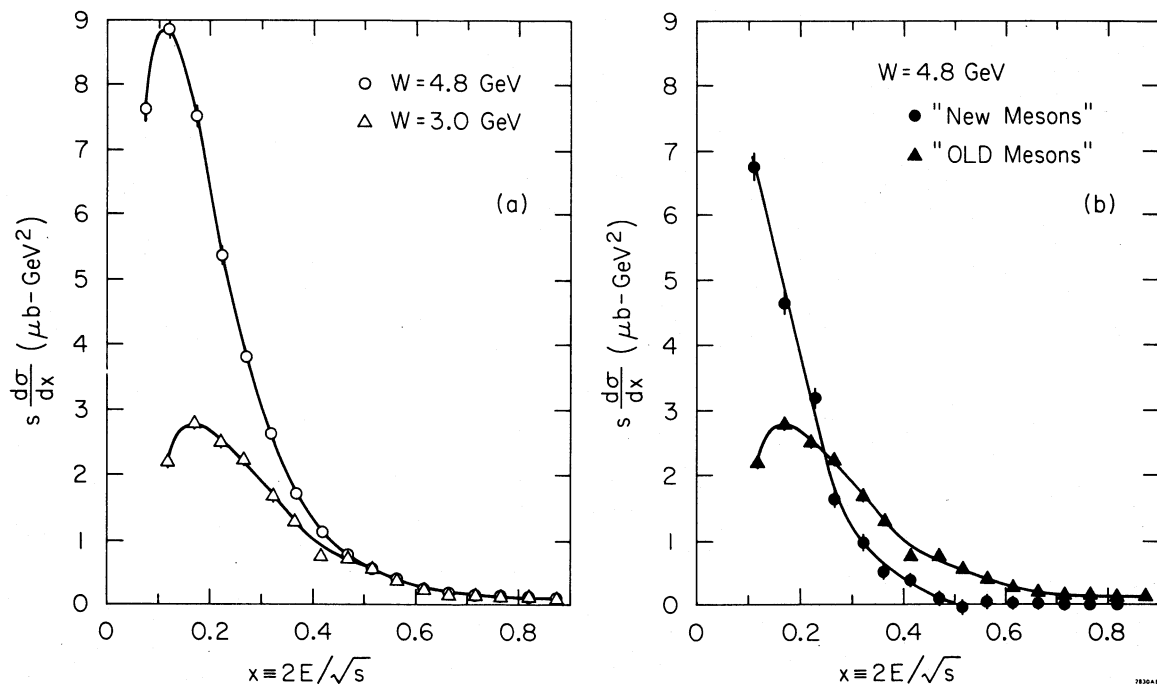

Fig. 8--The inclusive charged particle spectrum at W = 3 and 4.8 GeV interpreted as "old" and "new" physics.

(iv) The apparent energy fraction taken by charged particles is decreasing, as expected (but the alleged reason for it, namely the large K/π ratio, did not materialize!)

(v) The inclusive spectrum of hadrons coming from the decays of the new particles is limited to $x < 0.5$, as expected (figure 8).

(vi) No peaks are observed in invariant mass plots for $K\pi$, $\pi\pi$, $K\pi\pi$, $\pi\pi\pi$ final states³⁹. This by itself should not be so worrisome, if the D-mesons decay on the average into four particles. However, since $\langle n \rangle_{ch} \sim 2$, it is hard to see how they can avoid substantial decays into two body channels.

(vii) The events of the type $e^+e^- \rightarrow e^\pm + \mu^\pm + \text{neutrals}$ which are observed at SPEAR^{7,10} are too numerous and have the wrong properties for purely leptonic D-meson decays (more in section XIV).

(viii) The increment in R is 2.5-3, twice the expected value of 4/3.

We conclude that the K/π ratio, the value of R, the $e^\pm \mu^\mp$ events, and probably also the combination of low multiplicity and absence of $K\pi$ peaks, present the charm scheme with very serious difficulties. We will now see, however, that the picture may change radically if the $e^\pm \mu^\mp$ events^{7,10} represent the production and decay of a heavy lepton pair.

XIV. A NEW HEAVY LEPTON AND ITS PREDICTED PROPERTIES

The $e^+e^- \rightarrow e^\pm \mu^\mp$ events found at SPEAR^{7,10} seem to indicate very clearly that a pair of new particles are created. The simplest explanation for these events is the process:

$$e^+e^- \rightarrow U^+ + U^-$$

Followed by

$$U^\pm \rightarrow e^\pm + \text{neutrals}; \quad U^\mp \rightarrow \mu^\mp + \text{neutrals}.$$

The two simplest possibilities for the interpretation of the U-particle are to identify it as a charmed meson or as a heavy lepton.

We believe that the heavy lepton possibility is strongly favored. The U-particle seems to decay into three particles rather than two¹⁰, the energy

dependence of its production is consistent with $1/s$ (but also with other possibilities)¹⁰; the rate is larger than expected for a D-meson; the e/μ ratio is inconsistent with a (V-A) decay of a pseudoscalar meson (but perhaps the lowest lying D is a vector meson?). All of these indicate (but do not prove) that the heavy lepton assumption is preferred.

We believe that there is one more important argument which points in the same direction. In figure 9a we plot the energy dependence of the quantity $(R-2.5)$, assuming that it represents the "new physics". If the $e^\pm\mu^\pm$ events are indeed due to D-mesons, their production rate should follow a similar curve including the peak at $W \sim 4.1$ GeV. Moreover, near the 4 GeV threshold, a D-meson will be produced almost at rest, and its two-body decay will always yield an e^\pm or μ^\pm with $p \sim 1$ GeV. Such a lepton has a very high detection probability in the SPEAR experiment, which identifies only leptons with $p \gtrsim 0.65$ GeV^{7,10}. Consequently, if the $e^\pm\mu^\pm$ events come from D-mesons, their observed rate has two good reasons to peak at $W \sim 4.1$ GeV: The real peak in R, and the large experimental efficiency. Figure 9b shows the quantity $\sigma_{\text{observed}}(e^+e^- \rightarrow e^\pm\mu^\pm) / \sigma(e^+e^- \rightarrow \mu^+\mu^-)$. It certainly does not peak at $W \sim 4.1$ GeV and it is perfectly consistent with a gradual rise from threshold towards a constant fraction of a unit of R, as expected for a heavy lepton.

We therefore conclude that we may be facing a new charged heavy lepton with a mass around 1.9 GeV.

Can the entire rise in R be due to it? Probably not, because of the ψ'' and ψ''' which have hadronic widths and because of our arguments in section IV.

In that case we may be in the incredible situation of producing new pairs of mesons and new pairs of heavy leptons with approximately the same mass. As a theoretical idea this sounds unbelievable. However, the $e^\pm\mu^\pm$ events do point towards a heavy lepton and the rest of the data, including the ψ -spectrum, point towards new quarks and their new mesons.

What are the predicted properties of such a heavy lepton?

(i) Its decay into strange particles is proportional to $\sin^2\theta_c \sim 5\%$. There may be perhaps another 5% from nonstrange final states which decay into $K\bar{K}$ pairs. The overall percentage of decays containing K-mesons is, at most, 10%.

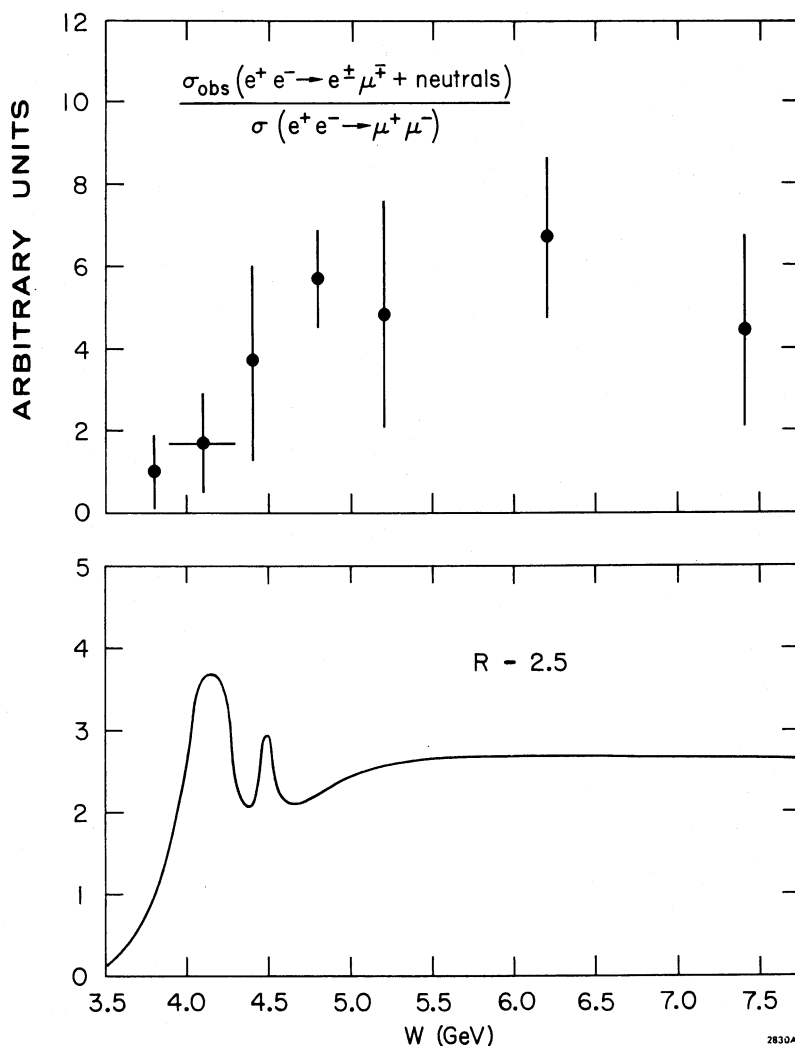

Figure 9: The "new physics" contribution to R and $\sigma_{\text{obs}}(e^+e^- \rightarrow e^\pm \mu^\mp) / \sigma(e^+e^- \rightarrow \mu^+ \mu^-)$ as a function of W .

(ii) The dominant decay modes are, presumably: $U^- \rightarrow e^- \bar{\nu}_e \nu_U$, $\mu^- \bar{\nu}_\mu \nu_U$, $\pi^- \nu_U$, $\pi^- \pi^0 \nu_U$, $\pi^- \pi^0 \pi^0 \nu_U$, $\pi^- \pi^- \pi^+ \nu_U$, etc. Of these, the first five have $n_{\text{ch}} = 1$ and the last has $n_{\text{ch}} = 3$. A reasonable guess for the average charged multiplicity is probably $\langle n \rangle_{\text{ch}} \sim 1.3-1.5$.

(iii) An unusually large percentage of the total energy is taken by neutral particles (the usual π^0 percentage plus the neutrinos!). We therefore expect $E_{\text{ch}}/E_{\text{tot}}$ to be below normal, probably well under 50%.

(iv) The predicted leptonic branching ratio³⁵ is:

$$\frac{U \rightarrow e \nu \nu}{U \rightarrow \text{all}} \sim 15 - 20\%$$

The observed rate indicates a branching ratio of 7-15%. This is reasonable.

In order to test these predictions we should be able to separate heavy lepton pairs from charmed meson pairs. If we could trigger on neutrinos(!) we could do it. At present, it is not easy to separate the two types of particles.

We can assume, however, that the heavy leptons obey the above properties, and then use the data in order to determine the experimental properties of the charmed mesons.

XV. COULD THE NEW PHYSICS, EXCEPT FOR THE HEAVY LEPTON PAIRS, BE DUE TO CHARM?

We now return to the data for the "new physics" which we discussed in section XIII, and "remove" from it the contribution of the heavy lepton, according to its predicted properties (section XIV). We find an amazing picture:

- (i) Both new thresholds are around $W \sim 4$ GeV. Of the "new physics" events 35-40% are due to the heavy lepton pair ($\Delta R = 1$) and 60-65% are due to the charmed mesons ($\Delta R \sim 1.5$).
- (ii) On the average, the number of K-mesons per event below or above $W \sim 4$ GeV is around 0.9 (assuming equal numbers of K^- , K^+ , K^0 , \bar{K}^0). But the heavy lepton pairs presumably contain an average of 0.2-0.3 K-mesons per event. This means that the rest of the new physics contains 1.3 K-mesons per event and each charmed meson decays on the average, into 0.65 K-mesons! This is in remarkable accord with the expectations of the charm idea!
- (iii) The averaged charged multiplicity of the "new physics" is $\langle n \rangle_{ch} \sim 4$. The heavy lepton pairs presumably have $\langle n \rangle_{ch} \sim 2.6-3$. Hence, the rest of the new physics has $\langle n \rangle_{ch} \sim 4.8$. This is closer to our original estimate of 5-5.5 (section XII).
- (iv) The apparent E_{ch}/E_{tot} is expected to decrease for both charmed mesons (because of K's) and heavy leptons (because of neutrinos). It does decrease experimentally⁸.
- (v) The inclusive cross section for both $D\bar{D}$ and U^+U^- is expected to be concentrated at $x < 0.5$, as it does experimentally (figure 8).

(vi) The absence of $K\pi$ peaks³⁴ is not so worrisome if $\langle n \rangle_{\text{ch}}$ is larger, and if only half of the new physics events come from $D\bar{D}$ pairs. For instance, the limit on $(D^+ \rightarrow \bar{K}^0 \pi^+) / (D^+ \rightarrow \text{all})$ is then³⁴ $\leq 7\%$ while the dominant modes are presumably the four body decays such as $K\pi\pi\pi$.

(vii) The $e^\pm \mu^\mp$ events are mostly or entirely explained by the heavy lepton pairs and pose no problem as far as the D-mesons are concerned.

(viii) The increment in R is 2.5-3 as compared with $\Delta R = \frac{4}{3}$ (possibly plus 10%-20%) for charm and $\Delta R = 1$ for the heavy lepton. The total "expected" ΔR is 2.5. The experimental R is still a bit too large, but it is not hopeless.

The overall lesson is clear - the presumed presence of a heavy lepton with the most reasonable properties, has completely changed the picture for the gross features of the new hadronic physics. The picture is now perfectly consistent with the charm scheme.

Three remarks should be added here -

(a) Several measurable quantities such as the K/π ratio and $\langle n \rangle_{\text{ch}}$ have similar values for the "old physics" and the "new physics" while they have radically different values for the two different components of the "new physics". This appears to be extremely artificial and unlikely. However, we reached this conclusion by analyzing the experimental observations rather than by inventing a new incredible theory. If the heavy lepton exists, we see no way of avoiding such a conclusion.

(b) Even if the K/π ratio and $\langle n \rangle_{\text{ch}}$ remain largely unchanged below and above the new threshold, we expect them to show a small but detectable peak around $W \sim 4.1$ GeV. Better data are needed to test this, but there is no experimental evidence for it at the moment.

(c) The charm scheme with four quarks and four leptons is theoretically very attractive (see section IX) but experimentally in grave trouble (section XIII). The addition of two leptons (for a total of six) restores the experimental viability of the four-quark model. However, its theoretical foundations are shaken. If we have six leptons and four quarks, the anomalies do not cancel and the quark-lepton symmetry disappears. Do we then need more quarks?

XVI. HOW MANY QUARKS AND HOW MANY LEPTONS?

Now that we have analyzed various possibilities concerning new quarks and leptons we may review the options which are open to us. We know that above $W \sim 4$ GeV we have $R \sim 5$ and the new physics corresponds to $\Delta R \sim 2.5$. This requires several new fermions. Starting with the well known four leptons (e, ν_e, μ, ν_μ) and three quarks (u, d, s) we now review the possibilities still remaining within the conventional V-A theory:

(A) One new quark (c) and no new leptons

This gives the wrong R and K/π ratio, and does not provide a reasonable explanation of the $\mu^\pm e^\mp$ events.

(B) Two or three new charged leptons. No new quarks

Does not explain either the narrow ψ, ψ' or the wide ψ'', ψ''' . Solves nothing. Almost certainly wrong.

(C) Three or two new quarks (c, t, b). No new leptons

Does not explain the spectrum of the Ψ -family (unless the quarks are degenerate³⁰ and more ψ -states are to be found). Gives the wrong K/π ratio and does not provide a reasonable explanation for the $\mu^\pm e^\mp$ events.

(D) One new quark (c) and two new leptons (U^-, ν_U)

Agrees with all known data. Does not possess quark-lepton symmetry. Anomalies are not cancelled.

We see that, at present, (D) seems to be the only viable scheme from the experimental point of view. Theoretically, however, we prefer to supplement the six leptons:

$$\begin{pmatrix} \nu_e \\ e^- \end{pmatrix} \quad \begin{pmatrix} \nu_\mu \\ \mu^- \end{pmatrix} \quad \begin{pmatrix} \nu_U \\ U^- \end{pmatrix}$$

with six quarks. Within a V-A theory, these must be (see section IX):

$$\begin{pmatrix} u \\ d' \end{pmatrix} \quad \begin{pmatrix} c' \\ s' \end{pmatrix} \quad \begin{pmatrix} t' \\ b \end{pmatrix}$$

where t, b have electric charges $+\frac{2}{3}, -\frac{1}{3}$, respectively. The t and b quarks are presumably produced at energies above $\sqrt{7.8}$ GeV, or else we would have already seen the $t\bar{t}$ and/or $b\bar{b}$ vector mesons.

We find no experimental reason to introduce additional V+A currents into the scheme which involves six leptons and six quarks. The two muon events found in neutrino experiments at the Fermi laboratory^{13,14} could possibly provide us with such a reason. This might happen if the $\mu^+\mu^-$ events are proved to be too numerous to be produced by -

$$\nu + d \rightarrow \mu^- + c$$

followed by -

$$c \rightarrow s + \mu^+ + \nu_\mu$$

or if the $\mu^-\mu^-$ events¹⁴ are confirmed, and are proved to be too numerous for -

$$\nu + d \rightarrow \mu^- + u + c + \bar{c}$$

followed by -

$$\bar{c} \rightarrow \bar{s} + \mu^- + \bar{\nu}_\mu$$

At the moment we do not believe that the two-muon events necessitate a modified weak current³⁶, but more data are clearly needed.

The possibility of (V+A) currents is, however, theoretically interesting. We now turn to it.

XVII. DO WE HAVE A (V+A) CURRENT?

Empirically we know that the charged weak currents involving the u, d, s quarks and the four "old" leptons are of the V-A type. Theoretically, there is no reason to exclude the possibility of a V+A current for quarks and leptons. In fact such currents have been proposed with various motivations³⁷⁻⁴⁴, some of which related to the new particles. The right-handed quarks which couple to the (V+A) current cannot follow the same "weak-isospin" classification as the left-handed quarks. In fact, if all right handed quarks belong to weak-

isodoublets, we must have six quarks, and there is only one weak-isospin assignment. Since u cannot have a substantial $(V+A)$ transition into d or s , it must be in the same weak isodoublet with the right handed b -quark. That leaves only one question open: is the left handed c -quark associated with d or s ? The K_S-K_L mass difference⁴¹ as well as the PCAC analysis of $K \rightarrow 2\pi$ and $K \rightarrow 3\pi$ decay⁴⁵ prevents us from having^{39,42} a significant $V+A$ $c \leftrightarrow d$ transition. Hence, the right handed quarks must be classified as:^{40,41,44}

$$\begin{pmatrix} u \\ b \end{pmatrix}_R \quad \begin{pmatrix} t \\ d \end{pmatrix}_R \quad \begin{pmatrix} c \\ s \end{pmatrix}_R$$

as compared with:

$$\begin{pmatrix} u \\ d' \end{pmatrix}_L \quad \begin{pmatrix} c \\ s' \end{pmatrix}_L \quad \begin{pmatrix} t \\ b \end{pmatrix}_L$$

The introduction of similar $V+A$ currents into the leptonic world involves several new neutral leptons^{43,44} and theoretical complications related to nonconservation of lepton-number.

The theories with $V+A$ and $V-A$ currents can be rewritten, in the limit of zero fermion masses, as a pure vector theory^{42,43,44}. This is a very attractive idea, since it implies that the weak interactions are fundamentally pure parity conserving vector interactions like electromagnetism and, possibly, the strong interactions. According to this philosophy the mechanism which generates the fermion masses and the weak mixing angles, also generates parity violation and axial vector currents. This entire approach, however, is not free of theoretical difficulties, and we will have to watch its development in the next few months.

At this point we must repeat that, with the possible exception of the two-muon events at the Fermi laboratory, we see no experimental or phenomenological reason to introduce $V+A$ currents.

XVIII. WHAT NEXT?

As of now, August 22, 1975, it seems that below $\sqrt{s} \approx 8$ GeV, six leptons and four quarks are sufficient for accounting for all the experimental facts. The theory suggests that two additional quarks may be around the corner, and should be found in the next generation of e^+e^- machines.

However, many experimental surprises may appear in the next few months.

It is especially crucial to:

- (i) Verify that the U particle of the $e^+\mu^+$ events^{7,10} is indeed a lepton.
- (ii) Discover the charmed mesons.
- (iii) Study the ψ -spectrum with special emphasis on the $C = +1$ levels and the missing decays of ψ' .

On the theoretical front, the "burning" issue is, of course, the number of quarks and leptons and the nature of the weak currents.

The total number of "fundamental" fermions is now at least 18 (four tricolored quarks and six leptons) or perhaps 24 (six quarks and six leptons). This is comparable to the number of known hadrons when SU(3) symmetry was introduced. We cannot avoid the feeling that the connection between quarks and leptons⁴⁶ as well as attempts to explain the proliferation of "fundamental" fermions will occupy an important place on the theoretical agenda for the next few years.

REFERENCES

1. J.J. Aubert et al., Phys. Rev. Letters 33, 1404 (1974).
2. S.C.C. Ting, These Proceedings.
3. J.E. Augustin et al., Phys. Rev. Letters 33, 1406 (1974).
4. G.S. Abrams et al., Phys. Rev. Letters 33, 1453 (1974).
5. J.E. Augustin et al., Phys. Rev. Letters 34, 764 (1975).
6. G.J. Feldman et al., SLAC-PUB-1621 (=LBL-4220), August 1975.
7. M.L. Perl et al., SLAC-PUB-1626 (=LBL-4228), August 1975.
8. R. Schwitters, These Proceedings.
9. G.S. Abrams, These Proceedings.
10. G.J. Feldman, These Proceedings.
11. W. Braunschweig et al., DESY 75/20, July 1975.
12. B. Wiik, These Proceedings.
13. A. Benvenuti et al., Phys. Rev. Letters 34, 419 (1975).
14. C. Rubbia, These Proceedings.
15. B. Knapp et al., Phys. Rev. Letters 34, 1040 (1975),

- W. Lee, These Proceedings.
16. U. Camerini et al., Phys. Rev. Letters 35, 480 (1975),
R. Prepost, These Proceedings.
 17. See e.g. J.D. Bjorken, These Proceedings.
 18. G. Zweig, unpublished, 1964,
J. Iizuka, Supplement to Progress of Theoretical Phys. 37-38, 21 (1966).
 19. See e.g. G.J. Gounaris, E.K. Manesis and A. Verganelakis, Phys. Letters 56B, 457 (1975), C.A. Dominguez and M. Greco, submitted to this symposium.
 20. See e.g. O.W. Greenberg Proceedings of the Coral Gables Conference, 1975,
I. Bars and R.D. Peccei, Phys. Rev. Letters 34, 985 (1975),
G. Feldman and P.T. Matthews, Phys. Rev. Letters 35, 344 (1975),
S.Y. Tsai, Nihon preprint, submitted to this symposium,
A.I. Sanda and H. Terazawa, Rockefeller preprints, submitted to this
symposium, N. Marinescu and B. Stech, Heidelberg preprint, submitted to
this symposium, M. Kuroda and Y. Yamaguchi, Tokyo preprint, submitted to
this symposium, M. Kramer, D. Schildknecht and F. Steiner, DESY preprint,
submitted to this symposium, F.E. Close, CERN preprint, CERN-TH-2041,
submitted to this symposium, J.C. Pati and A. Salam, Phys. Rev. Letters
34, 613 (1975).
 21. M. Y. Han and Y. Nambu, Phys. Rev. 139, B1006 (1963).
 22. T. Appelquist and H.D. Politzer, Phys. Rev. Letters 34, 43 (1975).
 23. T. Appelquist et al., Phys. Rev. Letters 34, 365 (1975),
E. Eichten et al., Phys. Rev. Letters 34, 369 (1975).
 24. H. Harari, ψ chology, SLAC-PUB-1514, unpublished.
 25. B. Gittelman, These Proceedings.
 26. S.L. Adler, Phys. Rev. 177, 2426 (1969),
J.S. Bell and R. Jackiw, Nuovo Cimento 51, 47 (1969).
 27. C. Bouchiat, J. Iliopoulos and Ph. Meyer, Phys. Letters 38B, 519 (1972),
D. Gross and R. Jackiw, Phys. Rev. D6, 477 (1972).
 28. S.L. Glashow, J. Iliopoulos and L. Maiani, Phys. Rev. D2, 1285 (1970).
 29. H. Harari, Phys. Letters 57B, 265 (1975) and SLAC-PUB-1589, to be
published in Annals of Physics.
 30. R.M. Barnett, Phys. Rev. Letters 39, 41 (1975),
F.A. Wilczek, unpublished.
 31. E. Eichten et al., Cornell preprint CLNS-316, August 1975, submitted to
this symposium.
 32. H. Schnitzer, Brandeis preprint, submitted to this symposium.
 33. M. Gaillard, B.W. Lee and J.L. Rosner, Rev. Mod. Phys. 47, 277 (1975).
 34. A.M. Boyarski et al., Phys. Rev. Letters 35, 195 (1975).
 35. See e.g. M.L. Perl and P.A. Rapidis, SLAC-PUB-1496 (1974), unpublished.
 36. See also L. Wolfenstein, These Proceedings.
 37. For early references see e.g. R.N. Mohapatra, Phys. Rev. D6, 2023 (1972);
B.W. Lee, Phys. Rev. D6, 1188 (1972); J. Prentki and B. Zumino, Nuclear
Phys. B47, 99 (1972) and many other papers.
 38. R.M. Barnett, Phys. Rev. D11, 3246 (1975) and reference 30.
 39. A. De Rujula, H. Georgi and S.L. Glashow, Phys. Rev. Letters 35, 69 (1975).
 40. S. Pakvasa, W.A. Simmons and S.F. Tuan, Hawaii preprint UH-511-196-75,
June 1975.
 41. F.A. Wilczek, A. Zee, R.L. Kingley and S.B. Treiman, Fermilab-Pub-75/44-THY,
June 1975.
 42. H. Fritzsch and P. Minkowski, Cal.Tech. preprint, superseded by ref. 44.

43. A. De Rujula, H. Georgi and S.L. Glashow, Harvard preprint.
44. H. Fritzsch, M. Gell-Mann and P. Minkowski, Cal. Tech. preprint, CALT-68-503.
45. E. Golowich and B.R. Holstein, Univ. of Mass. preprint (1975).
46. See e.g. J.C. Pati and A. Salam, Phys. Rev. D8, 1240 (1973), H. Georgi and S.L. Glashow, Phys. Rev. Letters 32, 438 (1974), H. Fritzsch and P. Minkowski, Cal.Tech. preprint (1975).

DISCUSSION

J. Rosner, Minnesota: As this looks like the last chance for this, can you or someone else show a slide of the fit to the angular correlations of e and mu in the e-mu events based on the heavy lepton hypothesis?

H. Harari: I don't have the slide. Perhaps Martin Perl has it.

M. Perl, SLAC: We don't have the slide with us. I will certainly bring one in on Monday. I would like, however, to make one comment. In my optimistic and cheerful moments I certainly agree with many of Haim's thoughts about the U particle. But sometimes in the middle of the night, or very early in the morning, I wake up with the following worry about all this. When we make these fits and seem to see the heavy lepton as having a reasonable fit, we are assuming that all the e-mu events left after background subtraction are produced by a single mechanism, namely a production of particles of one type only. If the U particles are of several different types (heavy leptons, various charmed mesons, etc.), all being produced together, and the background is mixed into it in a strange way, then we have no real understanding of the events, and many hypotheses can fit again. I want to emphasize that the heavy lepton is the simplest hypothesis at the moment, but it is not the only one. The job of verifying that the U is indeed a heavy lepton requires getting rid of all other possibilities, including very complicated ones such as three or four things happening at once. We fully realize the magnitude of making such a claim.

Harari: I think Fred Gilman would agree with me that both our talks were worthwhile if they served to impress you with the crucial importance of fully understanding these e-mu events. Whether or not the simple charm scheme makes sense depends strongly upon the final understanding of these events.

H. Schnitzler, Brandeis University: I would like to point out that if the state found at 2800 MeV is the expected $\eta_c 0^-$ of charmonium spectroscopy, this would pose grave difficulties for those who view it as a non-relativistic system, since the $\psi(3.1) - \eta_c(2.8)$ splitting is half the $\psi(3.7) - \psi(3.1)$ splitting. It is hard to believe that this is a $(v/c)^2$ correction in non-relativistic models.

Harari: I didn't have time to discuss that point, but I would add that the problems of the splittings of the states, namely the splittings between the 3P states (if they are indeed the states observed between the ψ and ψ') and the splittings between each vector and its friendly pseudoscalar, are important to the determination of the parameters of the potential, if indeed you can talk about such a potential. However, that type of problem is really a second-order problem in these charmonium models. You can see that these various splittings give one handle on whether the binding is relativistic or not, what kind of spin-orbit couplings there are, etc.

M. Roos, Helsinki: In the picture presented you put the 2^3S_1 state below the 3D_1 state? Are you forced to do that? Or could you identify the $\psi(3.7)$ with the 3D_1 state?

Harari: Well, according to these models the D states would have a vanishing wave function at the origin, and the wave function at the origin is the only thing that determines the decay rates of these particles into lepton pairs. Now we know that the $\psi(3.7)$ decay rate into lepton pairs is approximately half of the $\psi(3.1)$ decay rate into lepton pairs. Therefore, the wave function at the origin is presumably of the same order of magnitude in the two cases and is unlikely to be something which is vanishingly small. This is the motivation of the charmonium people for identifying it with the S state. As I said, there is a possibility of a small mixture. Now what is important is that if there is a mixture which is substantial, then this fellow 3D_1 should also be seen as a spike at SPEAR (whether narrow or wide is not clear, and the area under it depends on the mixing). That, presumably, has not been seen yet, but maybe it is so small that it will be seen. This is the party line on that issue.

H. Kluberg-Stern, Saclay: In your favored model a new heavy lepton and the charmed quark are solely relevant to the SPEAR data. You mentioned that all experimental SPEAR data are consistent with this model. From your point of view, to what channels do the charmed particles decay, since two- and three-body hadronic channels are still small? Do you expect any hadronic or semileptonic decay to be dominant?

Harari: Obviously, neither I nor anybody else knows what is the best game you can play. However, let me suggest one. The game is to look at $\bar{p}p$ annihilation at rest, which is a system of mass 1.9 GeV (which is close to the mass of the alleged charmed meson) decaying into mesons, and to copy it, except that every time you see a couple of pions there you replace it by a K meson here, because there are many pions there but here you need a K meson. Let's take this as a guess for lack of anything else. If that is the case, then the most favored thing in the final state would be typically something like one kaon and three pions; there will be a fair number of events with one kaon and four pions and of one kaon and two pions, although the latter will be somewhat smaller. There will be very few events with one kaon and one pion, and that is more or less the case. The semileptonic branching ratio is still as unpredictable as ever. It is probably 5% or 10% or whatever, and I think that is the situation. Now, if you are asking how, experimentally, we are finally going to find them, there are obviously two possibilities. One has simply to get one or two or three more orders of magnitude of data on the $K\pi$ final states because that decay must exist at some level. What I mean is that even ψ decays sometimes into $\bar{p}p$, for example, although it occurs only once in 500 decays. Maybe the decay $D \rightarrow K\pi$ also occurs only at the 1/5% level. The other possibility is to look at things like K and 3π 's in the final state which is supposed to be an abundant decay mode, but this is very difficult to do experimentally. I don't see any alternative.

Kluberg-Stern: When you say abundant, do you mean 10% or more?

Harari: I would guess that $K3\pi$ is probably something of the order of 30% maybe, but this is just a wild guess. Don't forget that there are probably half a dozen different charged decay modes, so we are making life very difficult for the experimentalists (but then, they are reciprocating).

G. Karl, Guelph University: I would like to ask you about a point that I didn't understand. Why do you feel that the discovery of natural parity states between the ψ and ψ' forces you to assign ψ' to a radial excitation of ψ rather than having a model with several quarks in which ψ and ψ' are composed of different quarks? Or have I got you wrong?

Harari: No, no, you have got me right, except for the word "forces". I don't think it really forces anything but, in my opinion, there is a very strong indication in that direction because it is the simplest explanation. If that would have been the only thing that happened in the last month or so, I would have said that we have a big puzzle. In fact, that is what I did say a month ago, namely that the ψ spectrum does look like radial excitations and one new quark; but the value of R , which is a very important clue, certainly doesn't look like one new quark. If, however, the following things are happening and are descending upon you at the same time--(1) the $e-\mu$ events begin to look more and more like a heavy lepton, (2) the ψ spectrum begins to look more and more like that of a radial excitation, and (3) the two things are really performing the perfect crime by concealing everything in such a clever way--then I find this to be the simplest possibility at the moment. I am not forced, but I find it attractive.

C. A. Heusch, UC-Santa Cruz: I have a comment concerning your remark that one of the principal tasks of the experimentalists will be to dig up information that would make us understand the Zweig rule better. I feel that the first task in front of us is to prove or disprove that there is such a thing as the Zweig Rule. If, say, we don't find more strange particles in fully reconstructed $pp \rightarrow \psi + \dots$ events, then the Zweig Rule as we invoke it to explain the narrow width of the ψ 's is dead.

Harari: We are not sure whether the Zweig Rule is right. So far it has been right wherever it has been tested, but wherever means about four or five places so we are not sure. We have to test whether it is right or wrong in as many experiments as possible, and I made a partial list in my talk. Every such piece of quantitative evidence will give us parametrizations, and we will start to understand the importance of whether there are two or three gluons, of whether it is a light or heavy quark, etc., etc. In this way we will get more and more clues. Then the people who write the underlying theory behind all of this may have some kinds of things to contradict the theory or to prove it. It is that kind of thing which I am looking forward to. Any experimental piece of work that you can do that will kill or improve or explain or parametrize the Zweig Rule is very relevant, I think. If you can kill it you will give work to the speaker at the next conference.

J. Kirkby, SLAC: In my opinion, the easiest experimental way to pin down charm is the K/π ratio. I don't understand why you say that this extra lepton makes everything OK now. The present data shows a rise in this ratio of $10\% \pm 10\%$ as the center-of-mass energy is swept through 4 GeV, whereas in the absence of the lepton one would expect it to rise by roughly 50%. Would you go through the arithmetic to show how accurately the experimentalists need to measure this quantity before charm is in serious trouble?

Harari: I cannot give you a quantitative estimate of that, but I do want to give you two or three numbers. Let us take the most stupid possibility as an example.

Suppose that 5% of the heavy lepton decays have K-mesons in the events, and 60 - 70% of the charm particle decays have K-mesons, which is a typical estimate. Now what you have to do is to average these two numbers, with somewhat more weight for the charm number because the lepton gives you one unit of R , while charm gives you one and one-third or perhaps somewhat more. So you have as an average, say, 35%, perhaps an additional 5%, and that is it, roughly. Now in the "old" physics, approximately 40% of the events have some kind of K-meson in them. So what you find is that this crazy mixture of--half beef and half chicken, or whatever you want to call it--this mixture of heavy lepton and charm is really imitating the 35 - 40% very cleverly. Now you are asking me to put better numbers on it. I haven't done it as carefully as I would like to do, and as I will do, but I can guarantee that for anything I do, somebody else will get 10% more or 10% less. It is very hard to get better accuracy than that because you are averaging two uncertain numbers like this and asking only for variations. I think that if the heavy lepton is confirmed, the global K/π ratio will teach us very little. I say if the heavy lepton is confirmed. That is very crucial.

H. Lipkin, Weizmann Institute: Continuing along this same line, another possible signature for charmed pair production would be an apparent strangeness violation if one charmed particle decays with a kaon in the final state and the other without. If you had just a few events, with one kaon and three or five pions, and if you knew that all the particles had been seen, that would be enough to tie it down. What are the experimental possibilities for detecting this?

Harari: This question is simple enough so that even I can answer about the experimental situation. There are very, very few events which are fully reconstructed, namely that satisfy four-constraint or one-constraint fits, so that you can be absolutely sure that no K escapes. There are even fewer events which are fully reconstructed and have K/π identification on all particles. In fact, I have never heard of even one such event above 4 GeV although there might be one among the 50,000 or so events observed above that energy. So, at present, it is hopeless. I don't know what the chance for seeing this might be elsewhere, or with the new magnetic detector at SPEAR, which will have a much better solid angle and somewhat better K/π identification. I hope we don't have to wait for that, since it is two years away.

E. Derman, University of Pennsylvania: About a month ago, at the SLAC Summer Institute, you attributed the dimuon events of the same charge, seen in neutrino scattering, to the t and b quarks, which you now "postpone." How can you now account for these events with only c quarks in a $V - A$ framework?

Harari: I think that I said quite clearly that my opinions have changed in the last month. I think that is perfectly legitimate; this happens--to some of us at least. More seriously, I did not discuss dimuons since they will be discussed by Professor Wolfenstein next week. Incidentally, the V and A issue will be discussed by Ben Lee in his talk. I just didn't have enough time to get into all of this.

I would say that the opposite-charge dimuon events would be likely to come from the production of charmed particles. I don't know how the like-charge dimuon events are explained in this way. The last I heard there were only 4 such events, but perhaps next week we will have more. If they are confirmed, then this would be a possible motivation for introducing $V + A$ currents. Remember that what I said was that I do not see a definite motivation for introducing $V + A$ currents. Some of the people who introduced $V + A$ currents originally, for example, Glashow and company, did so in that context and

liked it as a possible explanation. It is a fairly involved question, and I hope that Wolfenstein will discuss it.

P. Condon, UC-Irvine: Have the experimentalists looked at the K/π ratio in events that have been selected to have a muon or electron present?

Harari: That is a very good question, but I don't know the answer.

Perl: The answer is no.

J. J. Sakurai, UCLA: I would like to point out that the decay of a heavy lepton provides a fantastic opportunity for cleaning up the "old" spectroscopy of G-odd pseudoscalar and axial vector states. It seems a little strange to me that we know so much about the 3P bound states of c and \bar{c} quarks while we don't even know whether the ordinary axial vector meson nonet is complete. For example, the question of whether or not the A_1 exists can be conclusively settled by looking for $U \rightarrow A_1 + \nu$. There are certain chiral symmetry estimates which were made long before heavy leptons became fashionable. By studying the decay products of the heavy leptons we can get information that could otherwise be obtained only by constructing an electron-antineutrino colliding-beam apparatus with an astronomical luminosity.

Harari: The whole situation is ridiculous. We have four excitations of the ψ but we haven't yet found the ϕ' , and, as you say, there is the problem of the A_1 . I mean that there are many respects in which the ψ spectroscopy is already better understood than the old spectroscopy, although far from being understood in all respects, of course. However, this is partly because they are narrow states and partly because of the unusual experimental circumstances.

G. A. Snow, University of Maryland: What would you speculate about the mass of the neutral brother of the heavy lepton?

Harari: That is a very good question. I have no speculations. As far as I am concerned, it could either be a massless neutrino, or it could even have a small mass. There is no evidence against some mass. Presumably, most of the analysis of the SPEAR people was done assuming a massless neutrino, but I am sure that, with the present data, much of the analysis wouldn't be affected if it had a mass of a few hundred MeV. I would find it very hard to believe that this neutrino has a very large mass because that would presumably affect all the momentum distributions, etc., but it is clearly an open question theoretically and experimentally.