

Introduction to Neuroscience – Behavioral Neuroscience

Social Neuroscience

Saikat Ray

Dept. of Brain Sciences, Weizmann Institute of Science

2022

Outline

Diversity of social behaviors

Aggression

Deconstruction of parenting

Social bonding and hierarchy

Representation of others – social identity

Nest building – Attracting mates

BBC
earth

*Unfortunately, this small
Japanese puffer fish is dull,*

https://www.youtube.com/watch?v=VQr8xDk_UaY

Coordinated Behavior – Hermit crab shell exchanges



<https://www.youtube.com/watch?v=f1dnocPQXDQ&t=30s>

Cooperative Behavior – Chimps cooperating



Cooperative Behavior – Across species

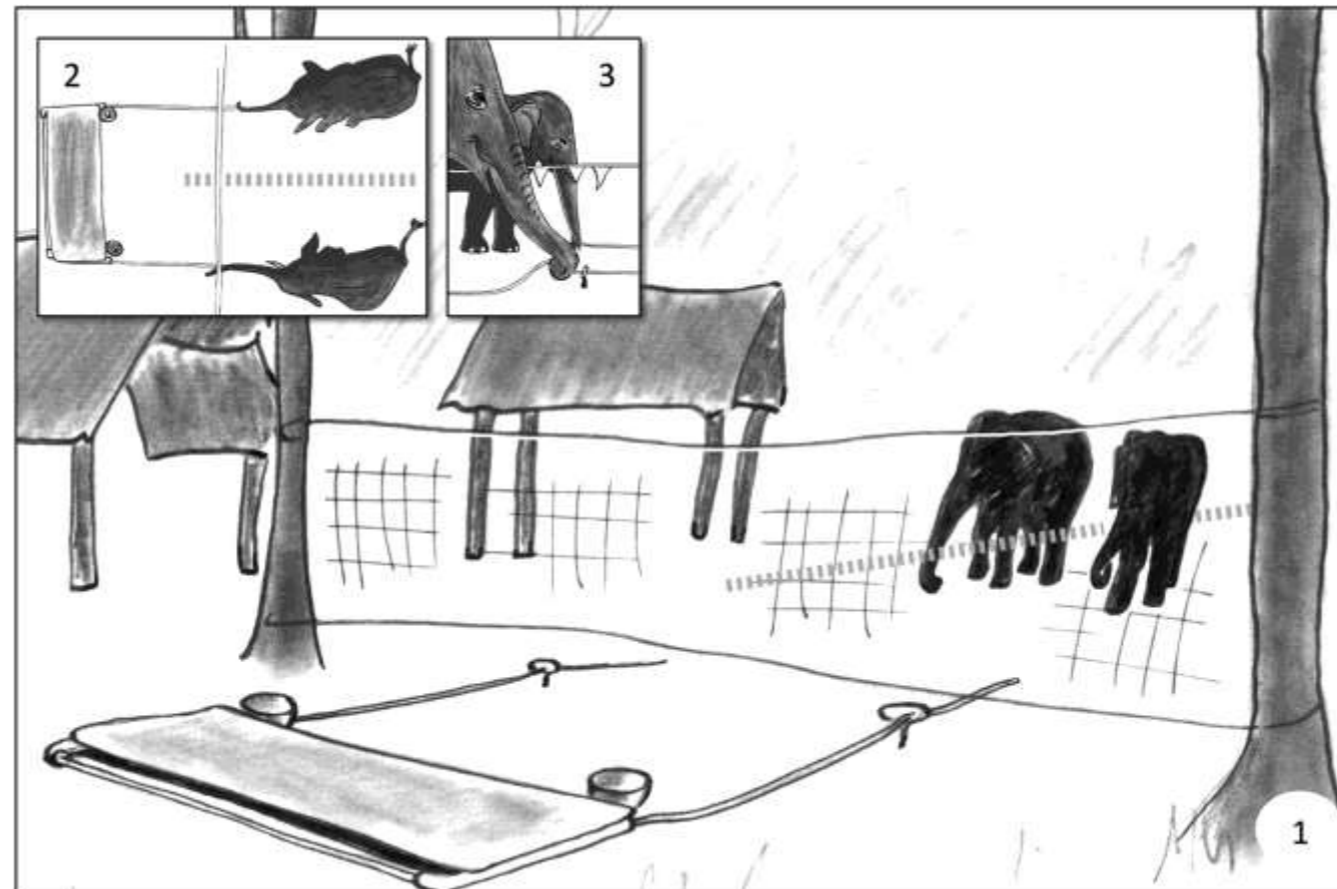
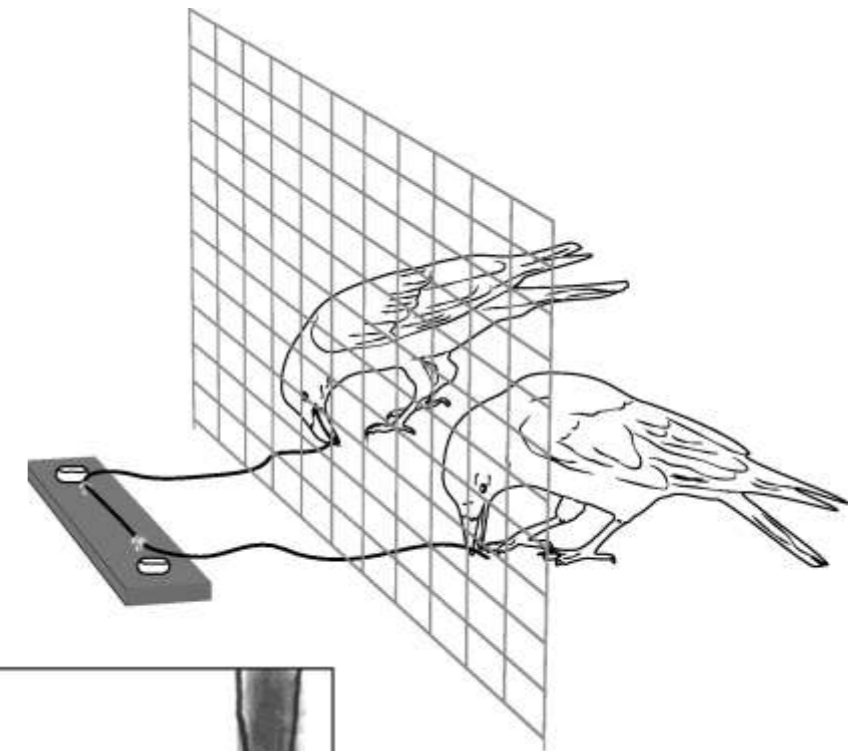
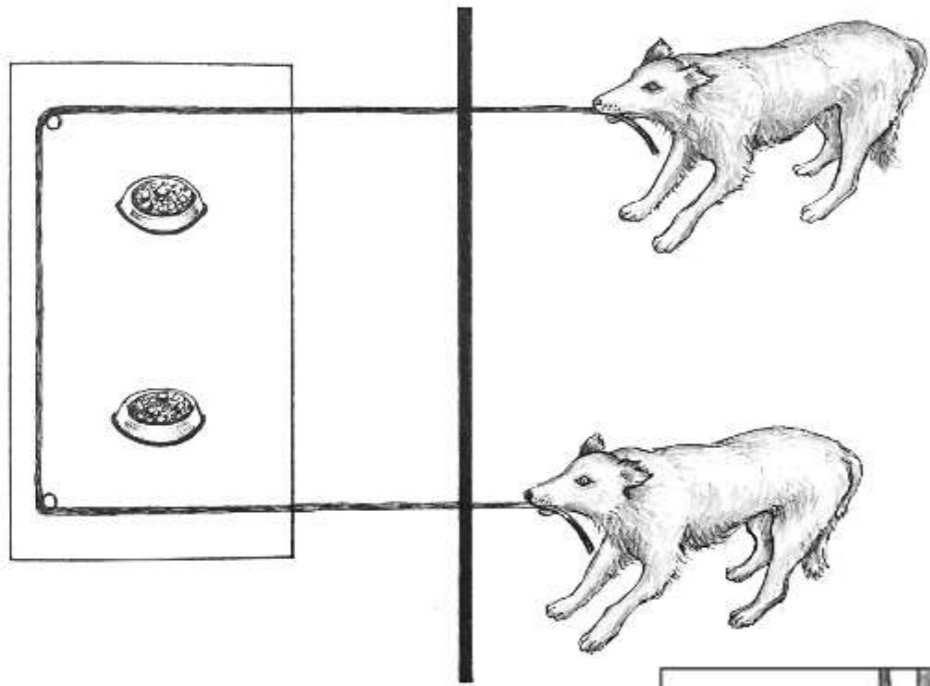

Aggression



Aggression

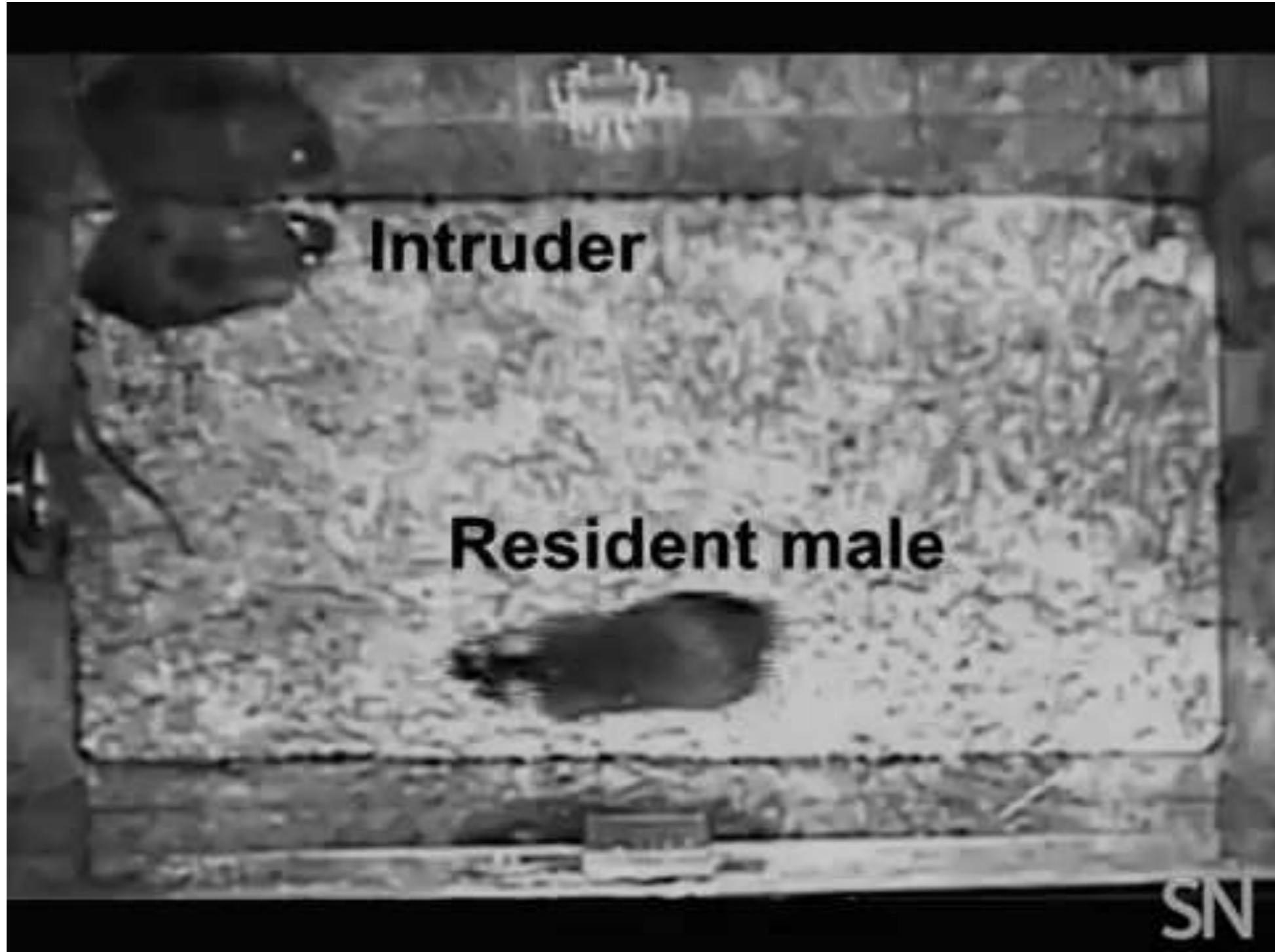

Aggression – Hypothalamus

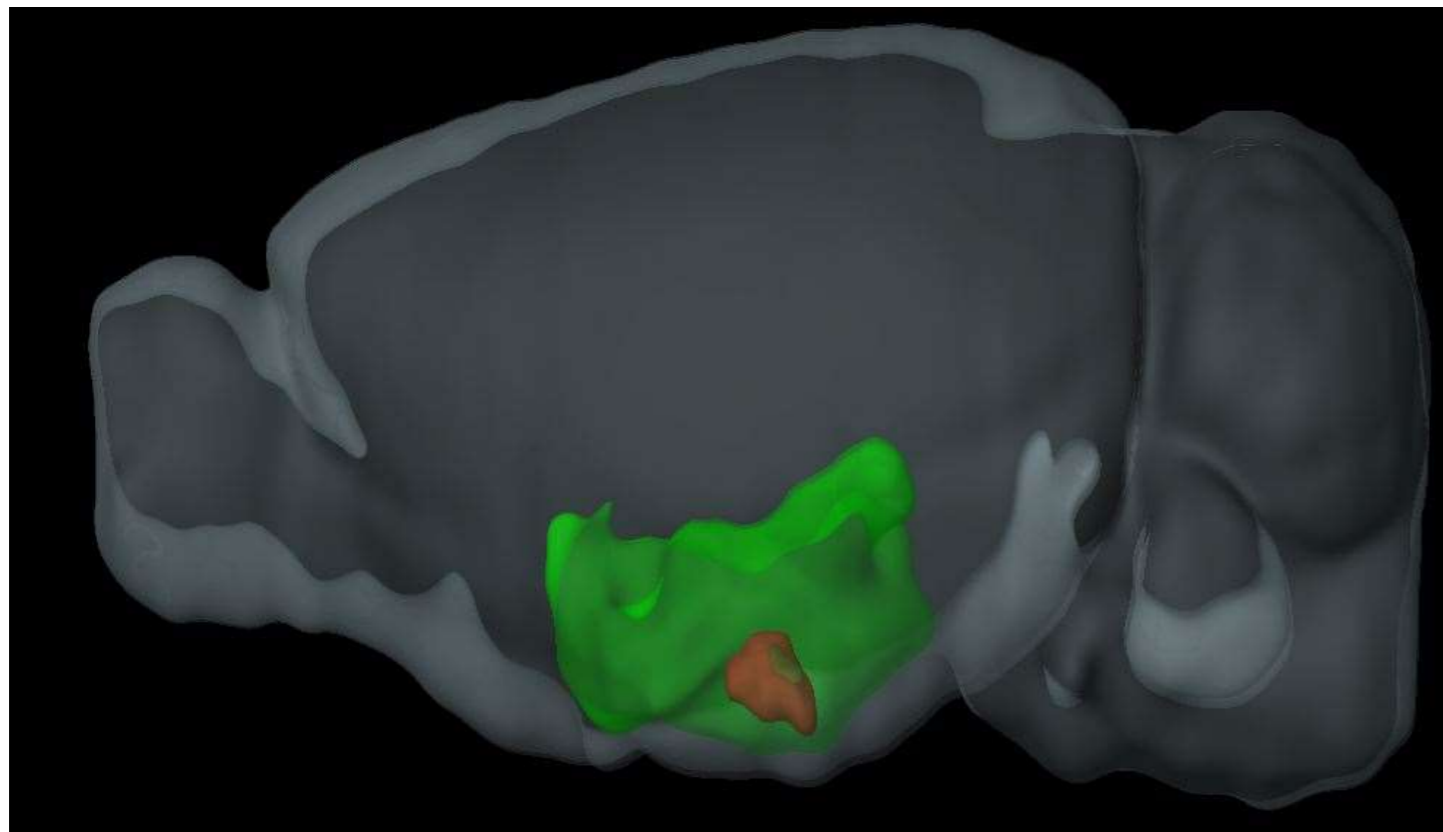

Hypothalamus

- Sleep
- Feeding
- Arousal
- Aggression
- Blood pressure
- Temperature Control
- Social hormones like oxytocin & vasopressin

Ventromedial nucleus

Aggression – Ventromedial hypothalamus

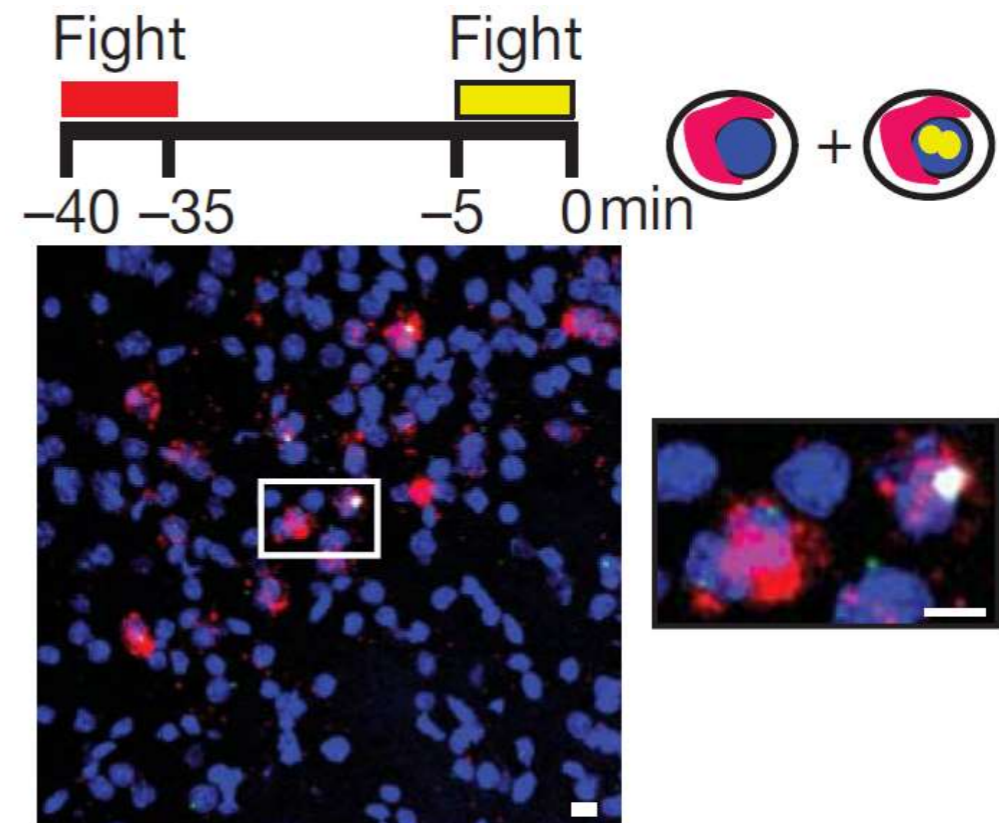
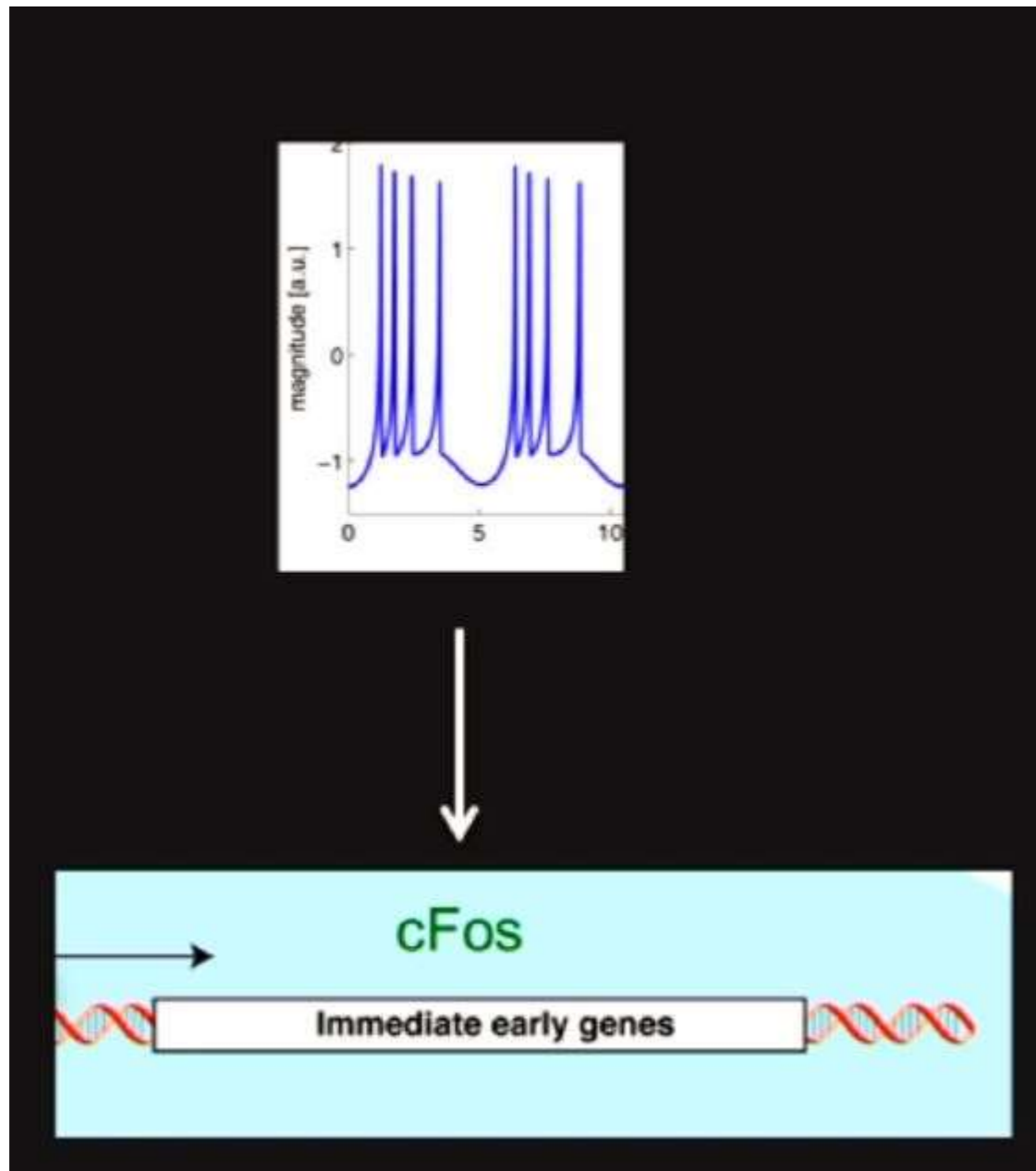

cFos+ cells in ventromedial hypothalamus

Aggression – Activating cells in ventromedial hypothalamus with optogenetics

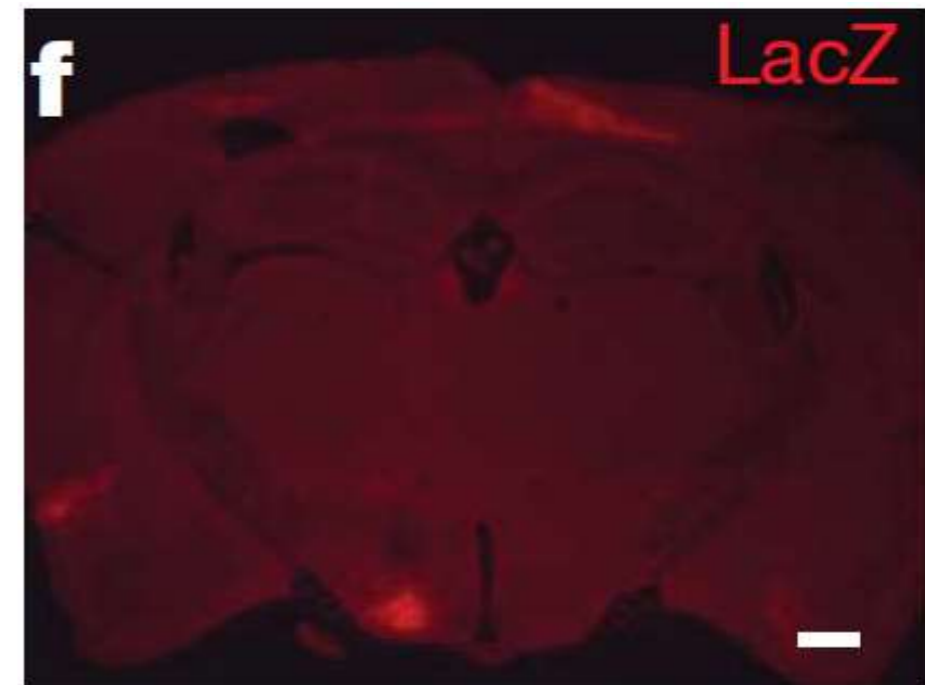
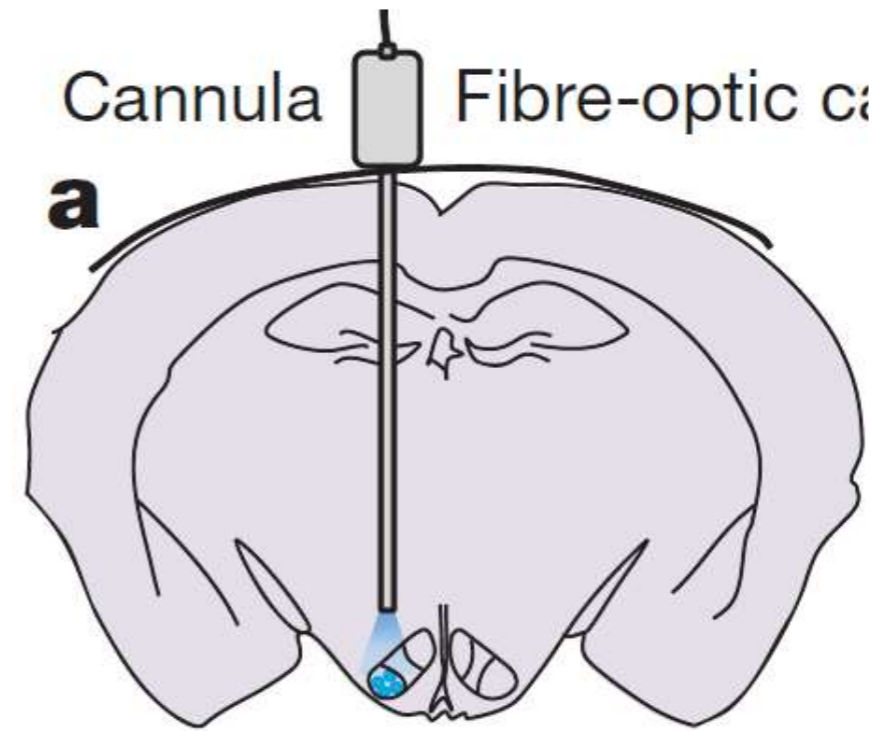
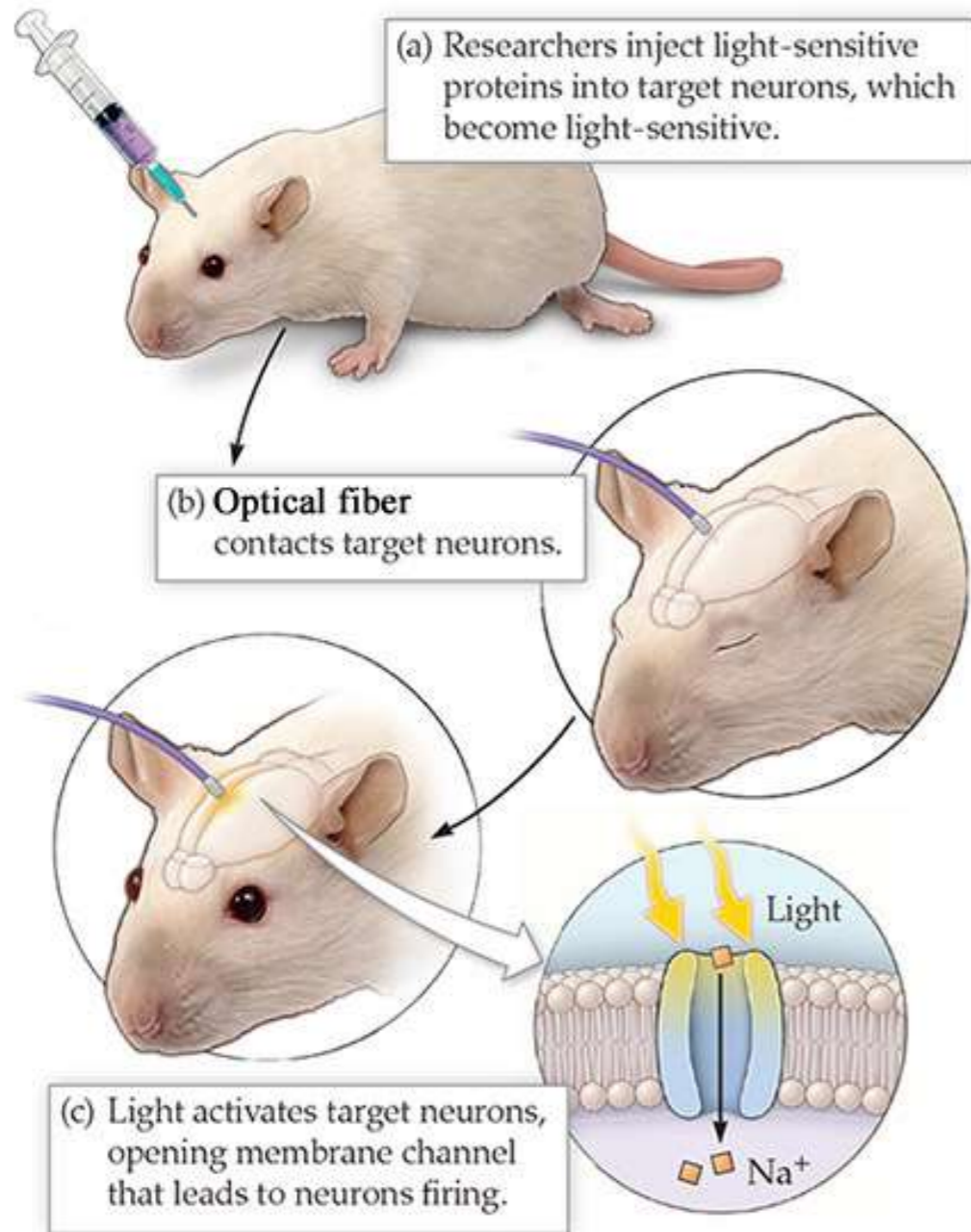

Aggression – Activating cells in ventromedial hypothalamus causes aggression



Aggression – Activating cells in ventromedial hypothalamus causes aggression

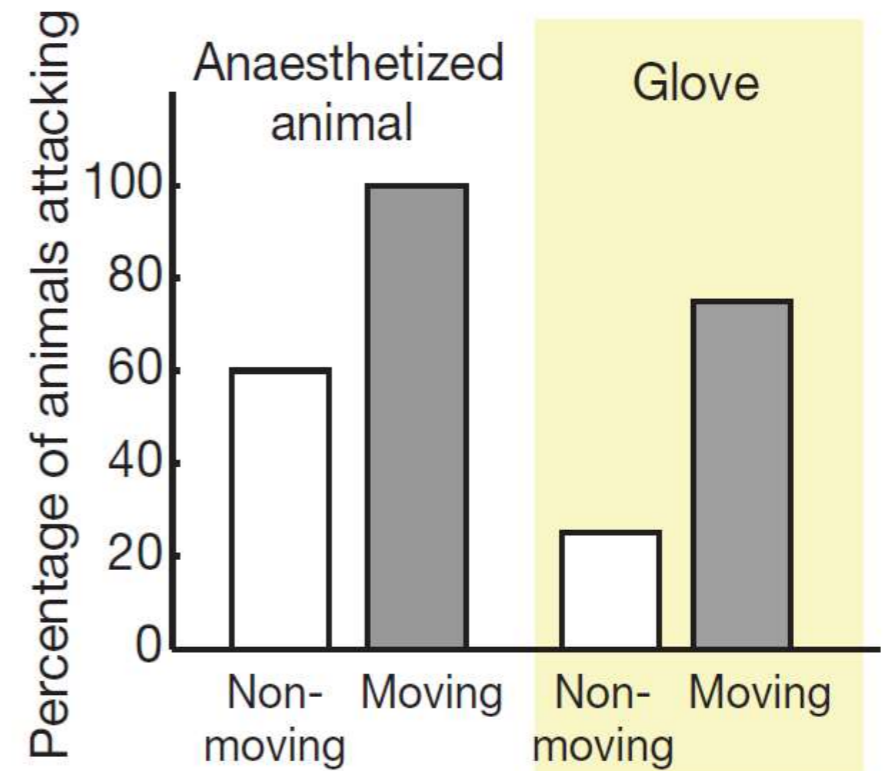

An interesting aspect was that they attacked moving objects more

Aggression – Infanticide of others' pups



Parenting – Switch from infanticide to parenting

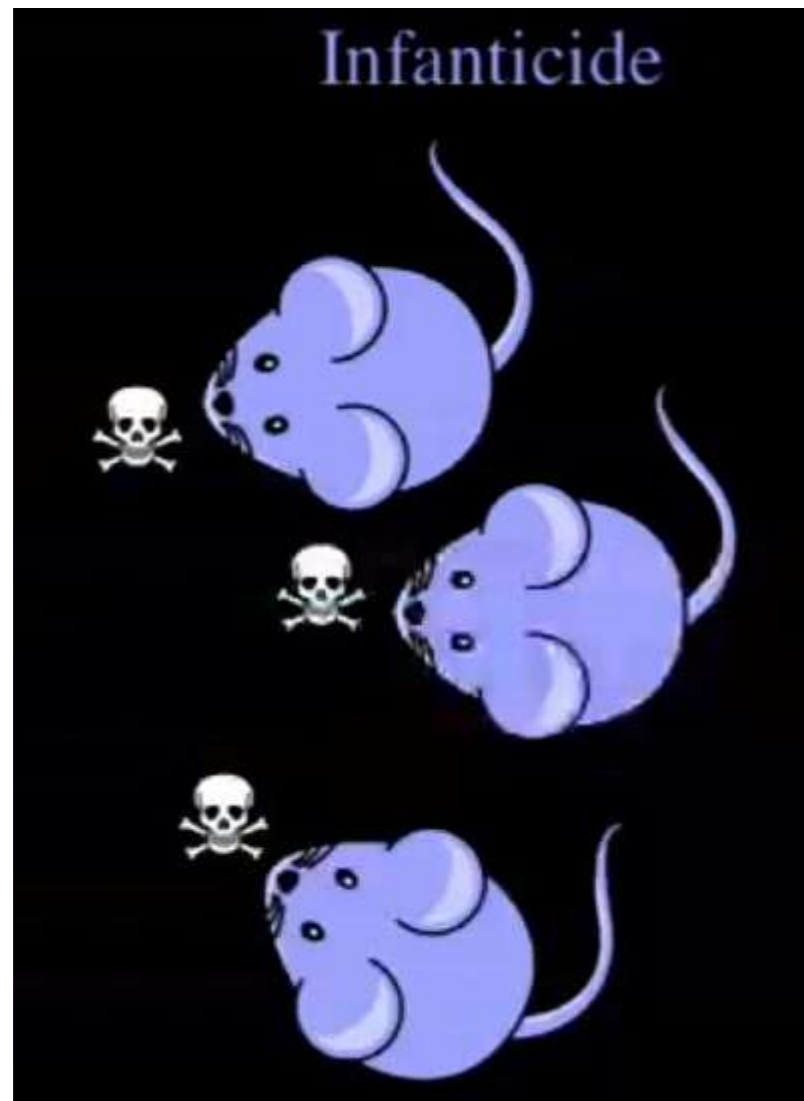

Male mice are normally infanticidal

Male mice who have mated, switch to parenting and not be infanticidal ~3 weeks after mating (which is the gestation time in mice) – also to others' pups

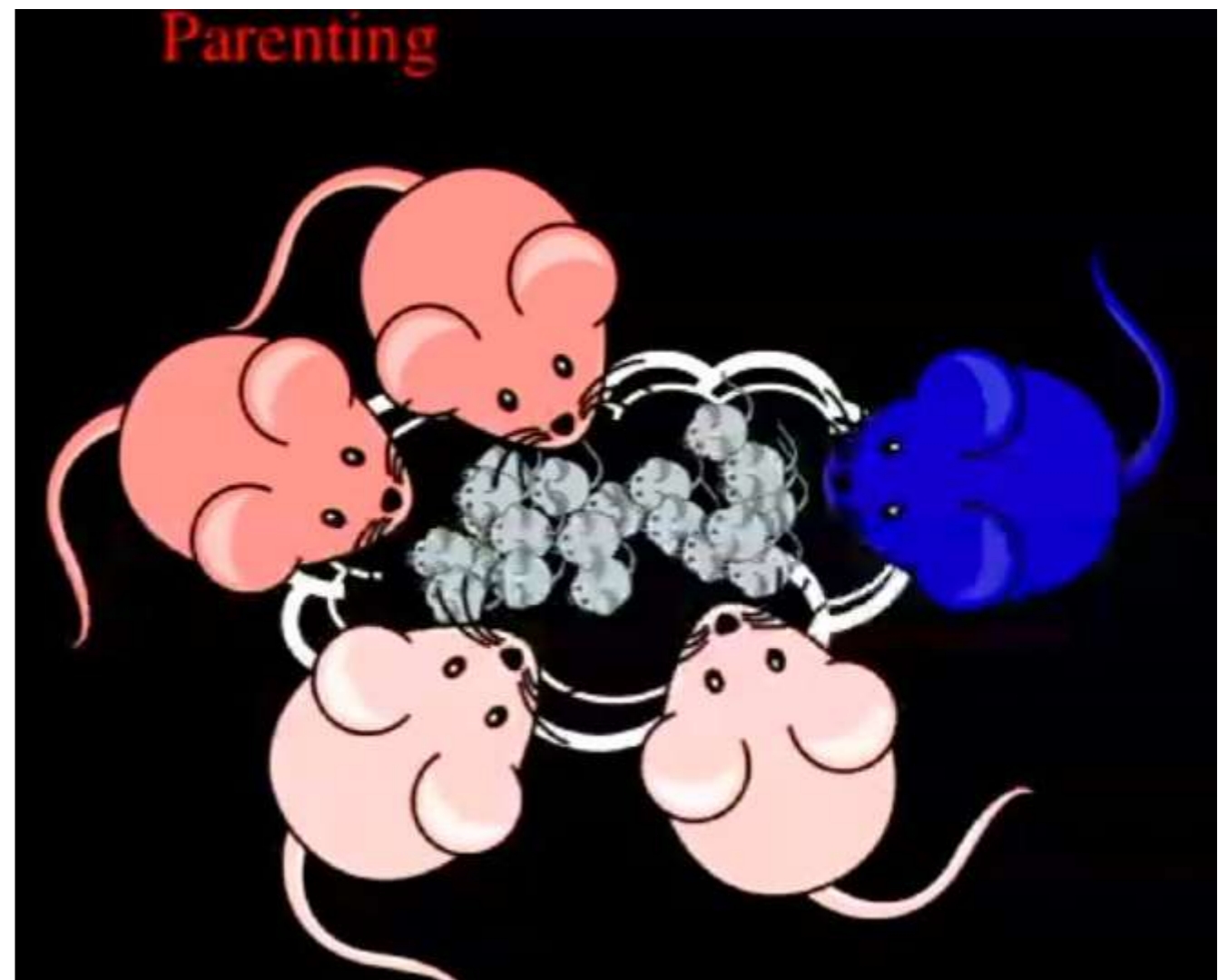

Parenting – What is changing in the brain?

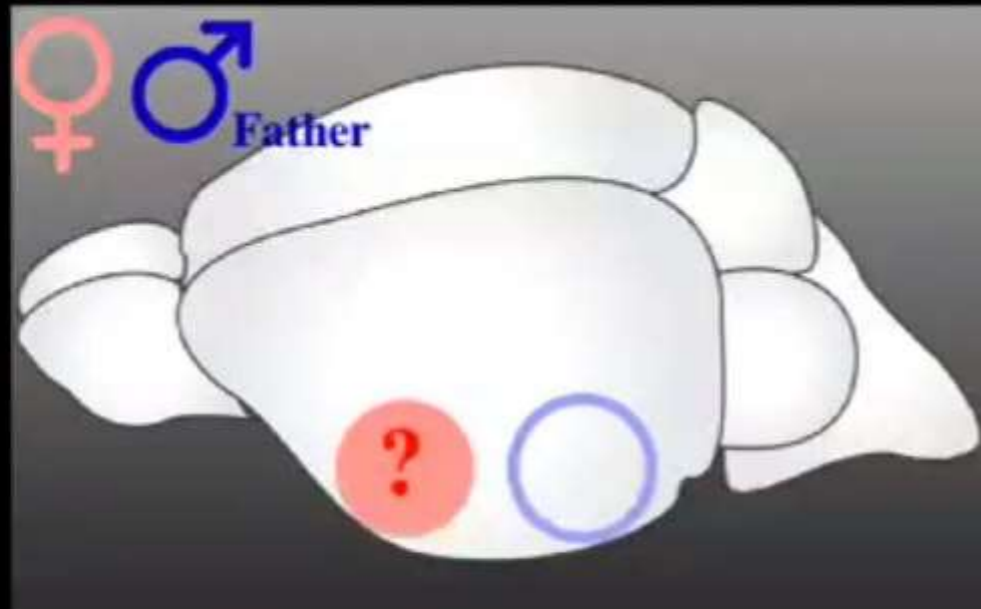

Parenting

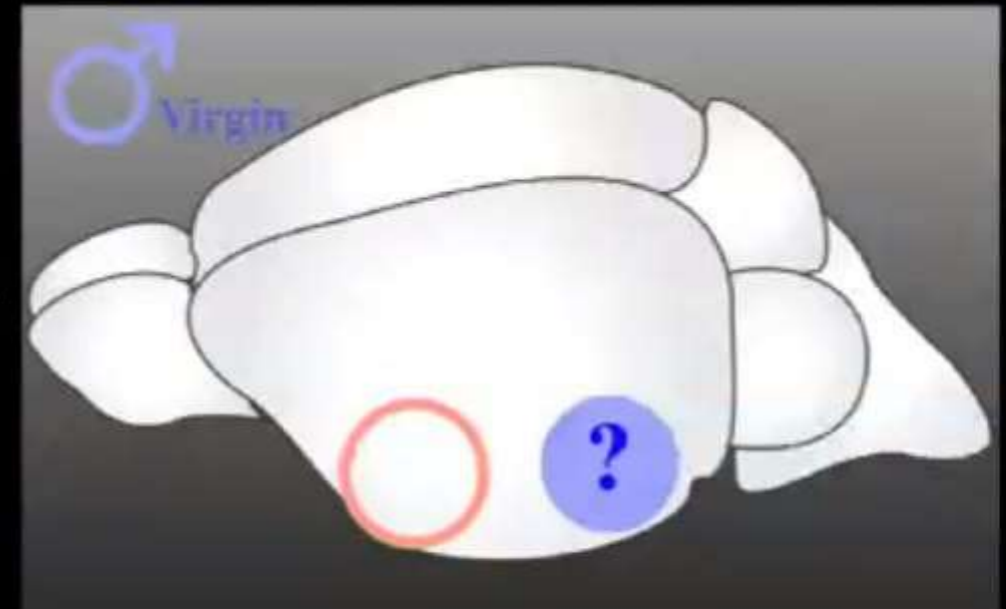

Infanticide

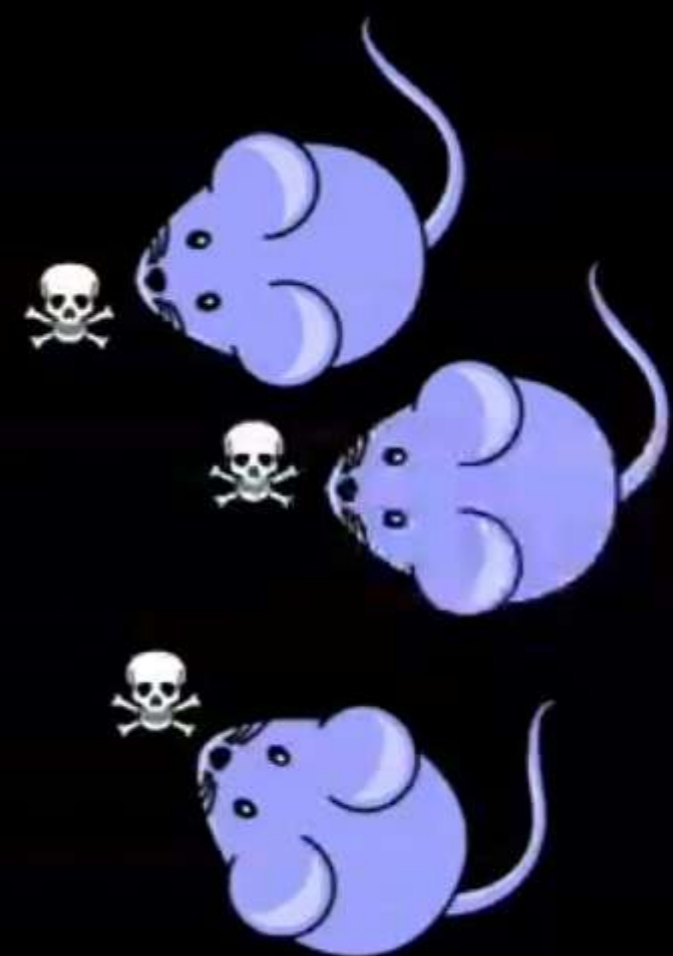
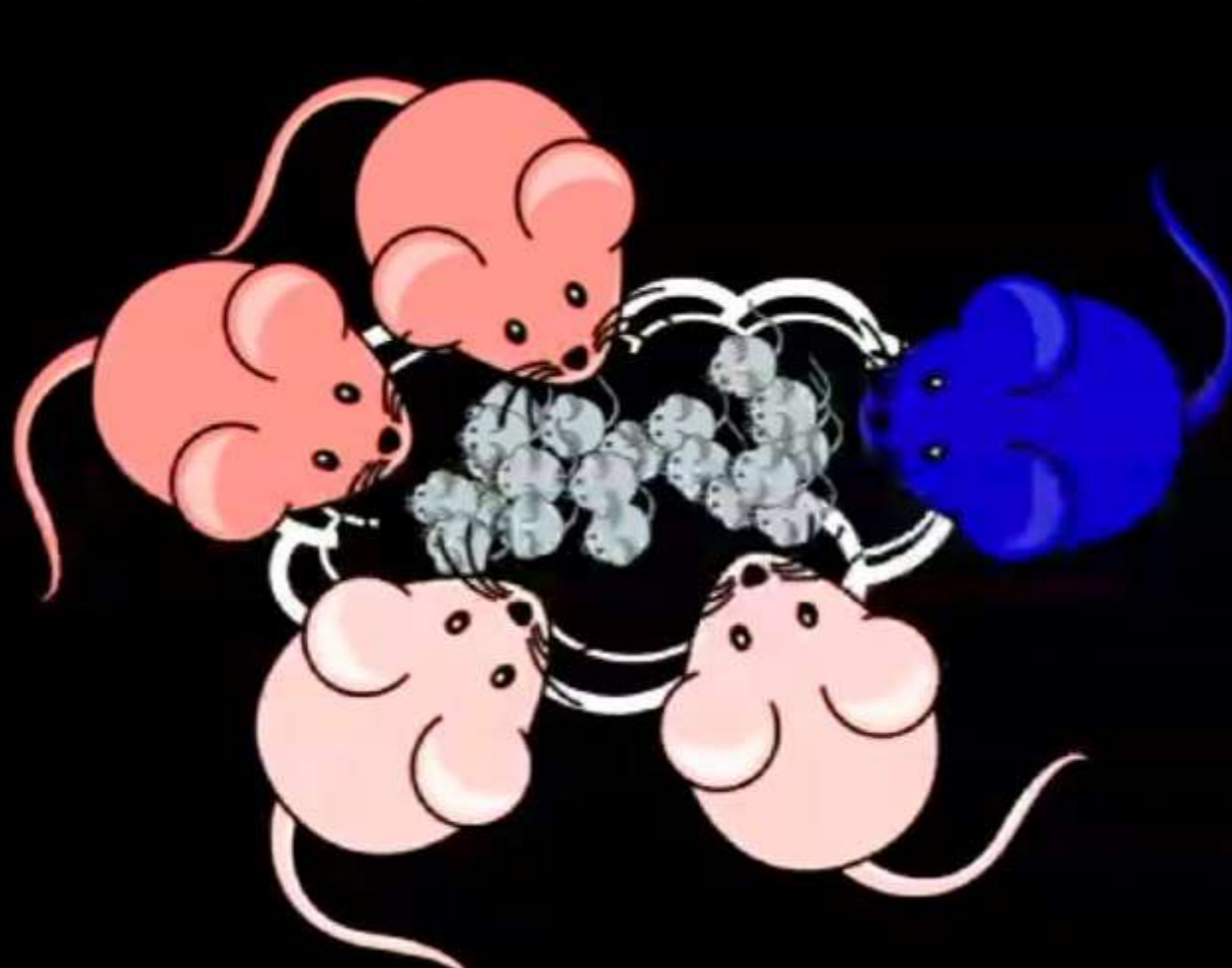

Parenting – What is changing in the brain?

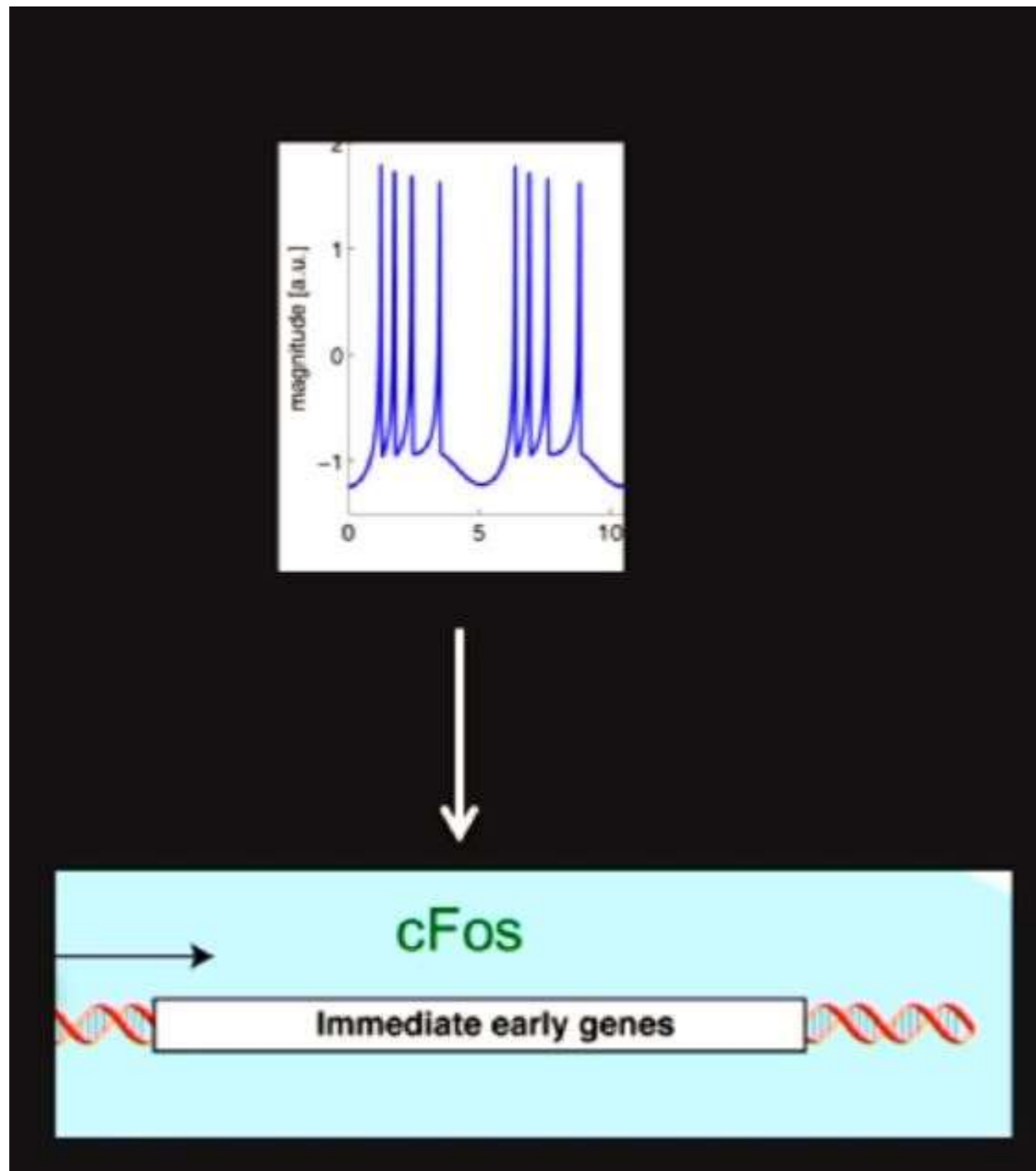

Dulac and colleagues

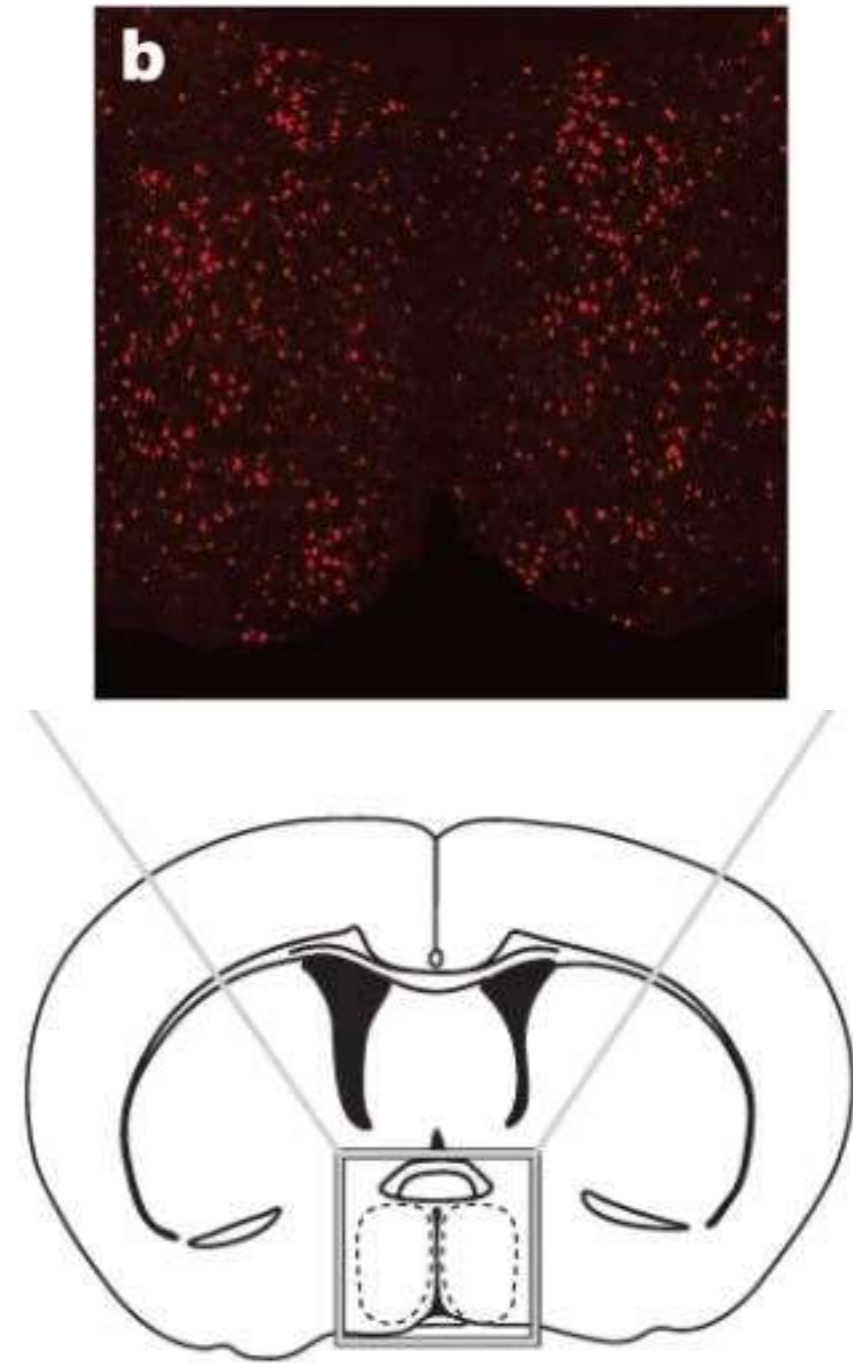

Medial preoptic area in hypothalamus

Parenting – What is changing in the brain?

Hypothalamus

- Sleep
- Feeding
- Arousal
- Aggression
- Blood pressure
- Temperature Control
- Social hormones like oxytocin & vasopressin

Medial Preoptic Area (MPOA)

- Sleep
- Temperature control
- Sexual behaviors
- Parental behaviors

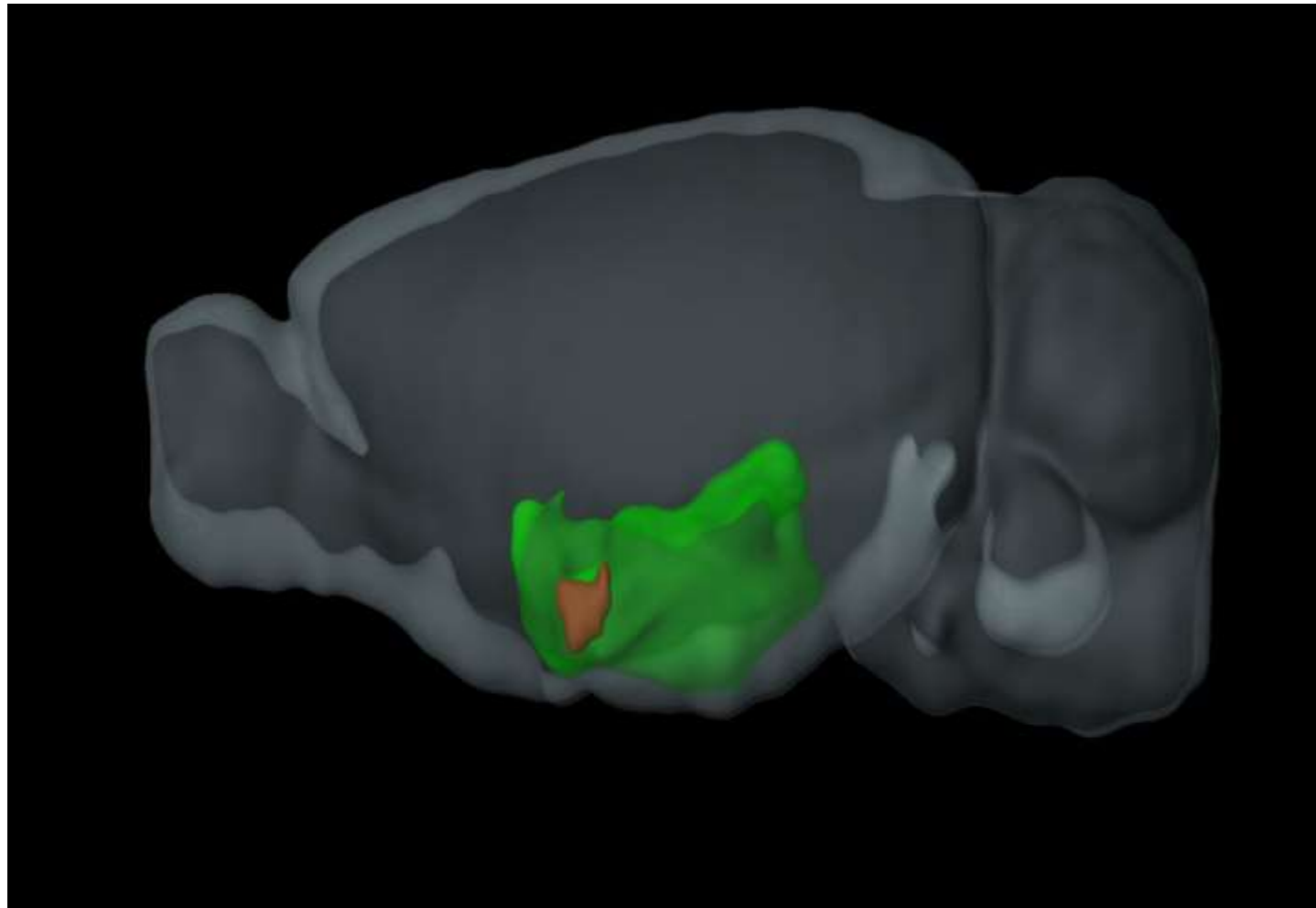

Parenting – Galanin+ neurons in MPOA activated in parents

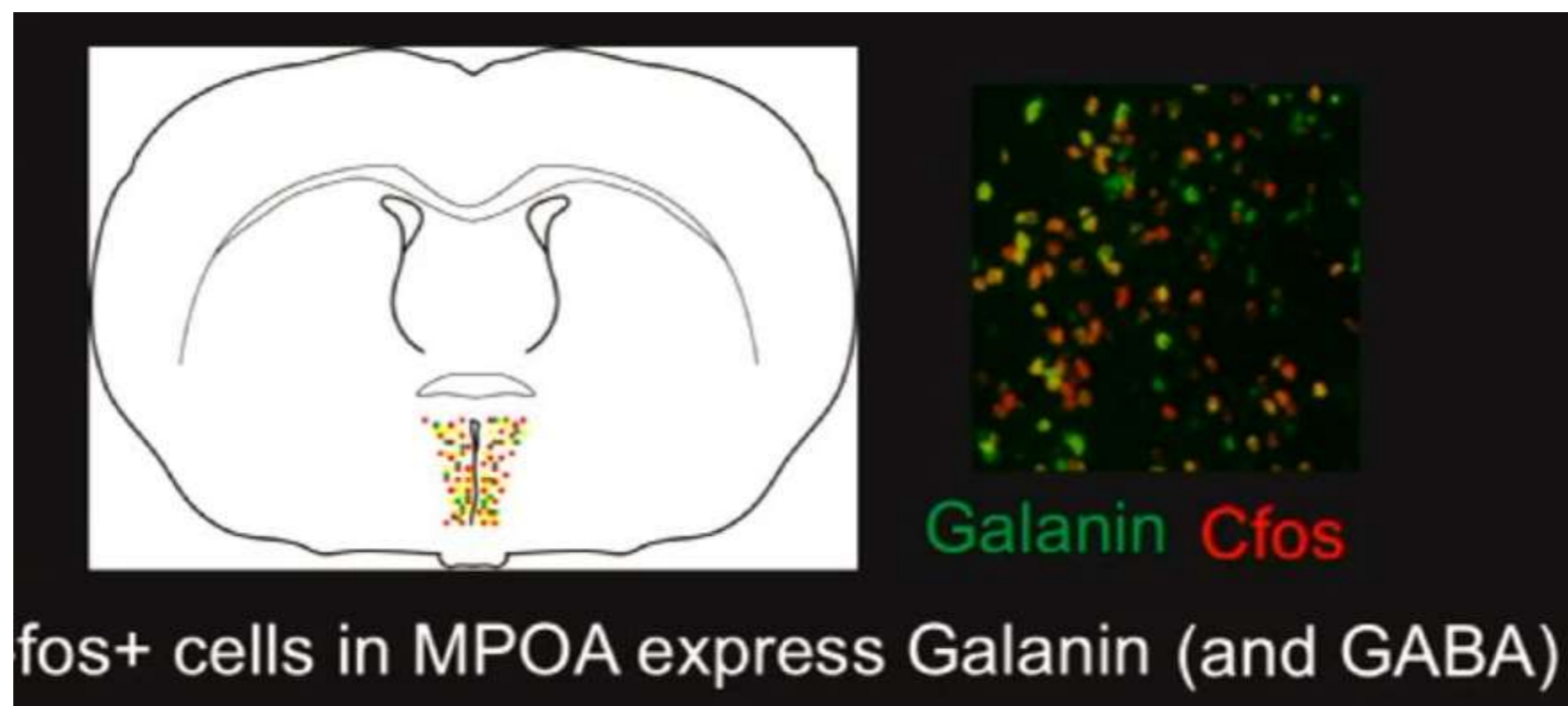
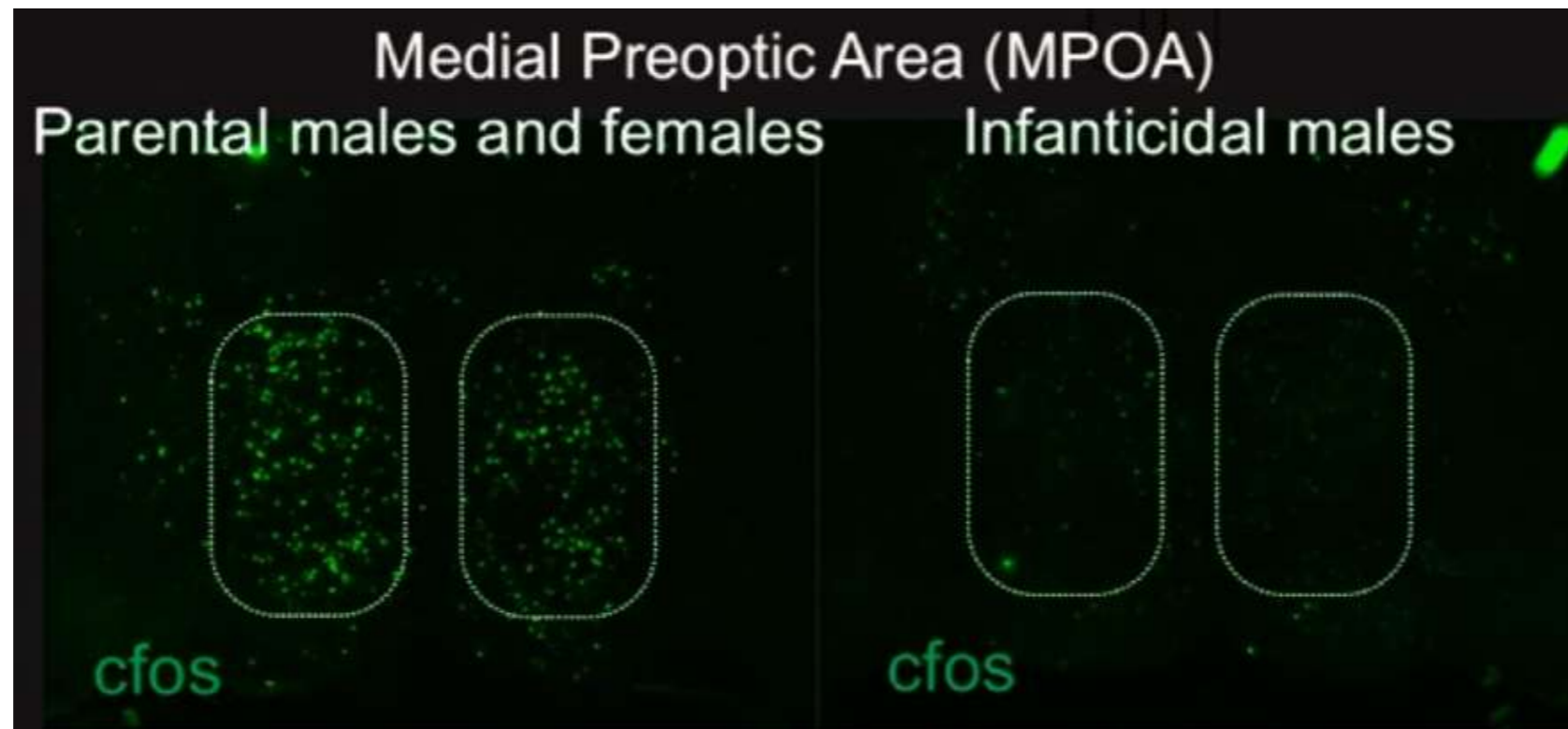

Parenting – Galanin+ neurons in MPOA



Cre mouse

To target only Gal+ neurons

**Inject virus with toxin in MPOA
to target only Gal+ neurons**

A diagram of a mouse brain in profile, viewed from the side. A dashed yellow circle highlights a region in the medial preoptic nucleus (MPOA). A grey pipette is shown injecting a substance into this region. The text 'Gal::Cre' is written above the brain, and 'AAV-FLEX-DTA' is written below the pipette. The background of the diagram is black.

**Ablation of MPOA^{Gal+} neurons abolishes
maternal and paternal behavior and elicits
infanticide**

Parenting – Galanin+ neurons in MPOA

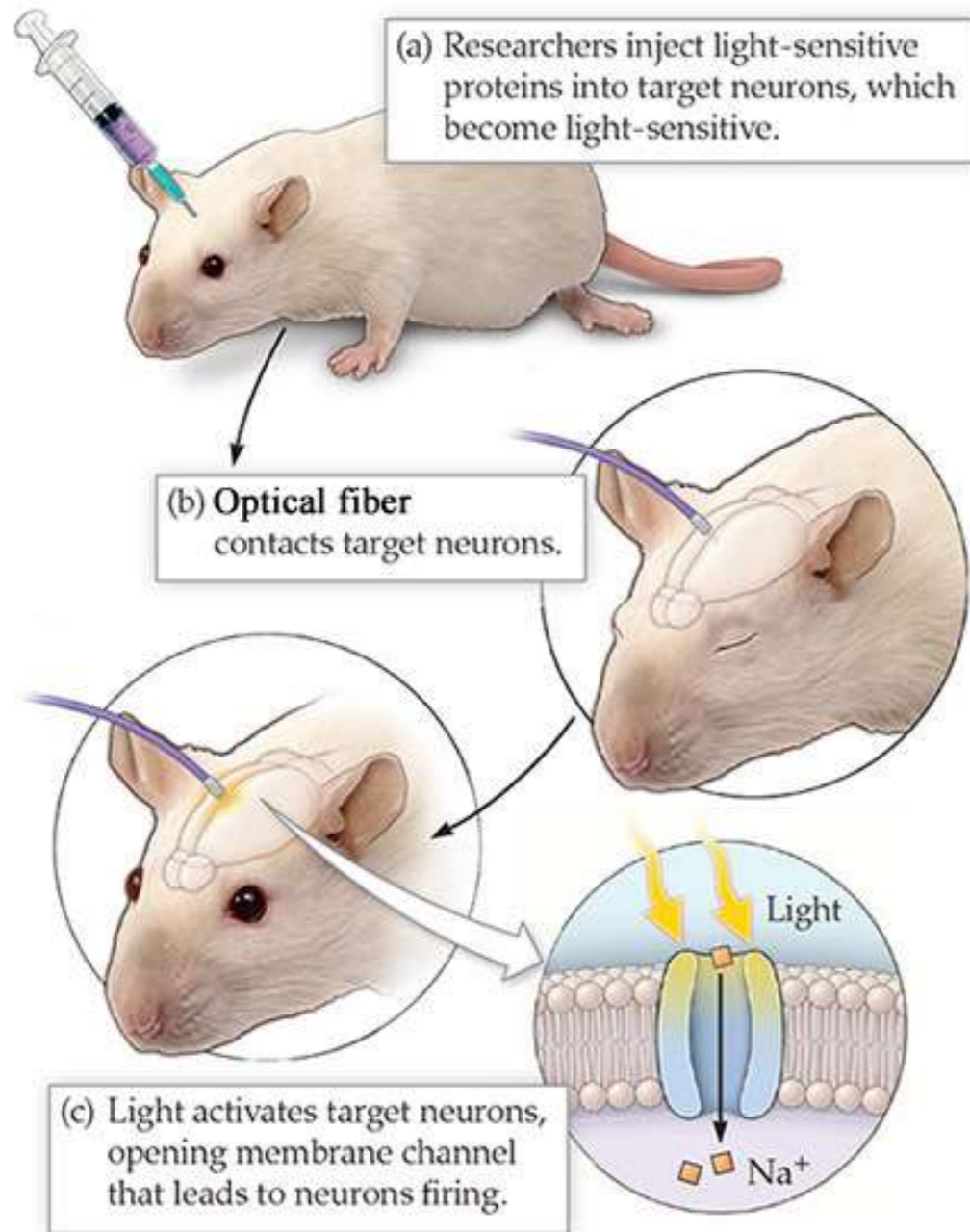

Inject virus with channelrhodopsin in MPOA to target only Gal+ neurons and then shine blue light to activate them

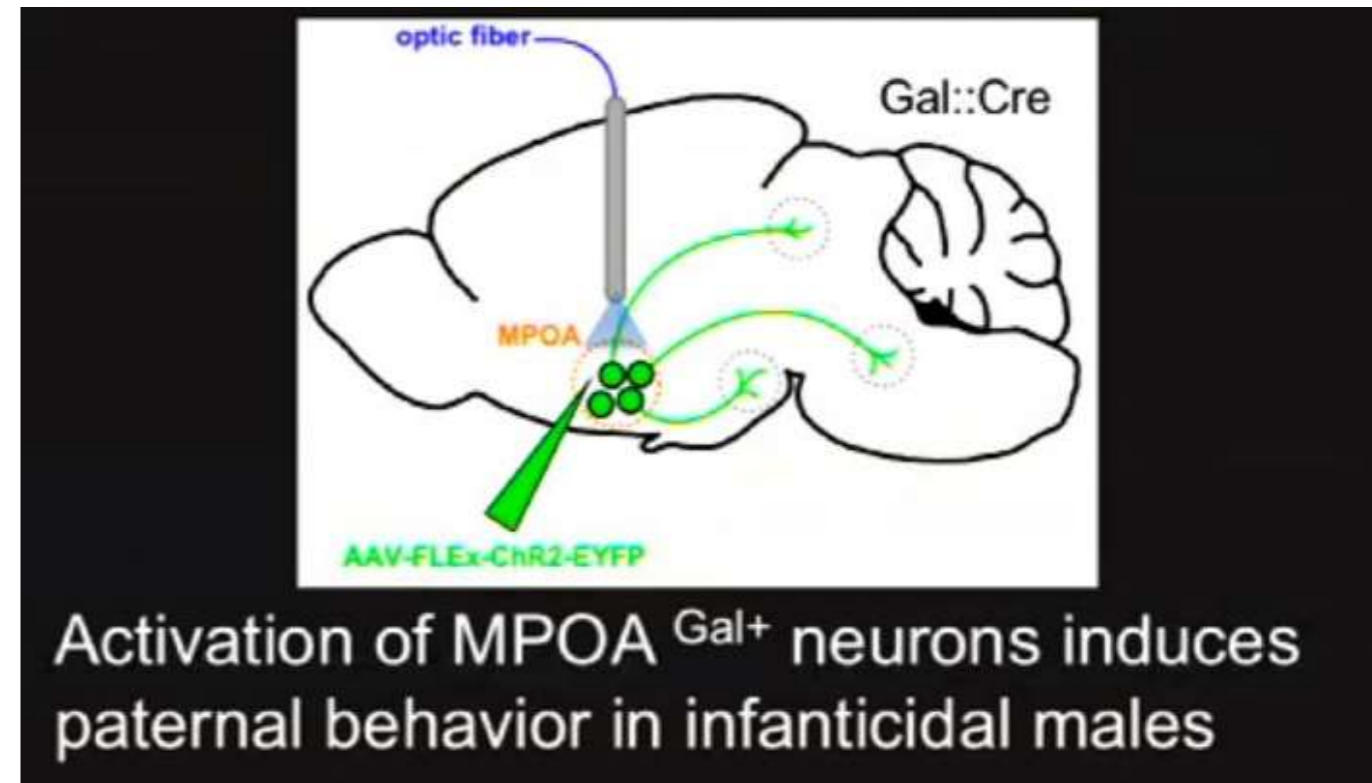

Parenting – Galanin+ neurons in MPOA

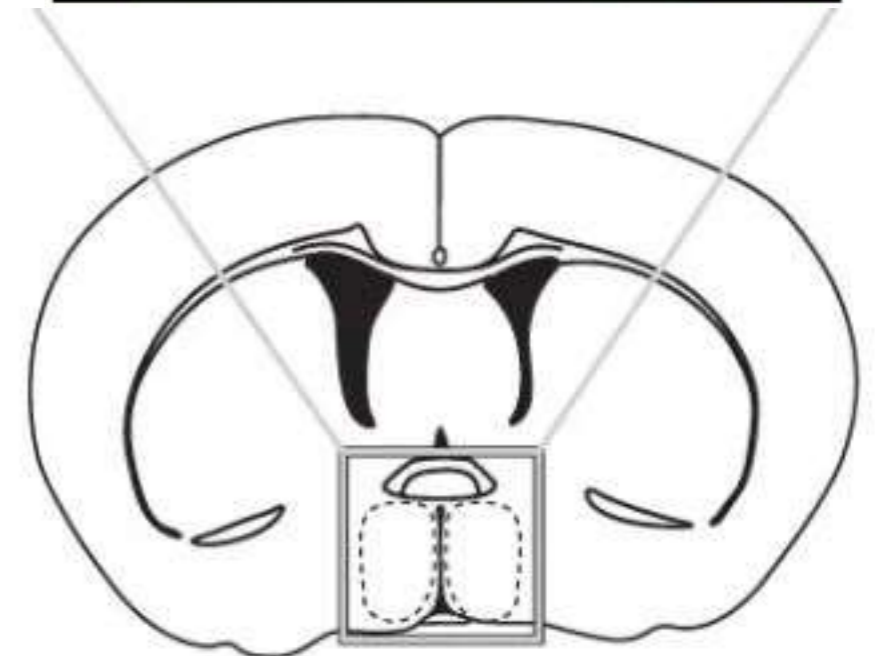
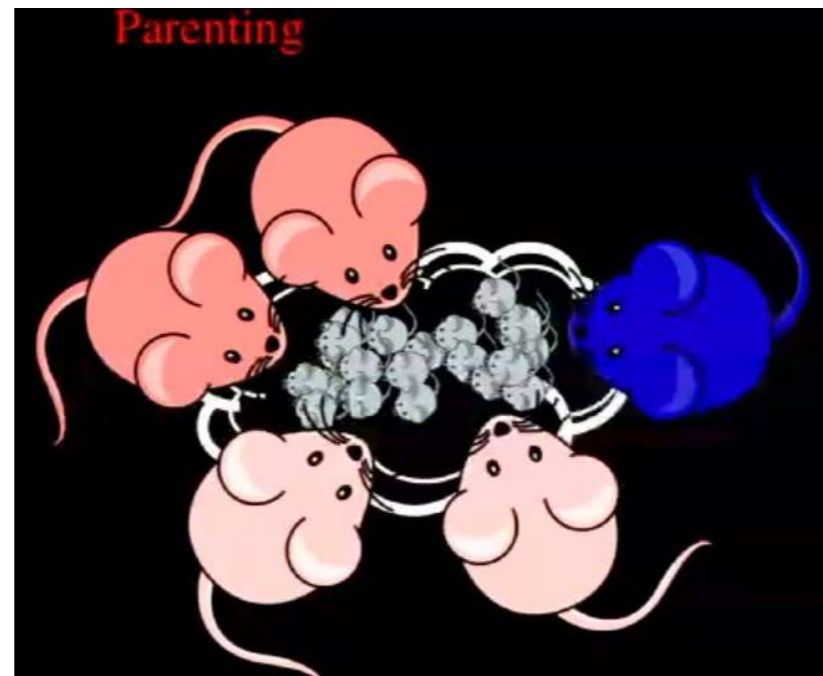
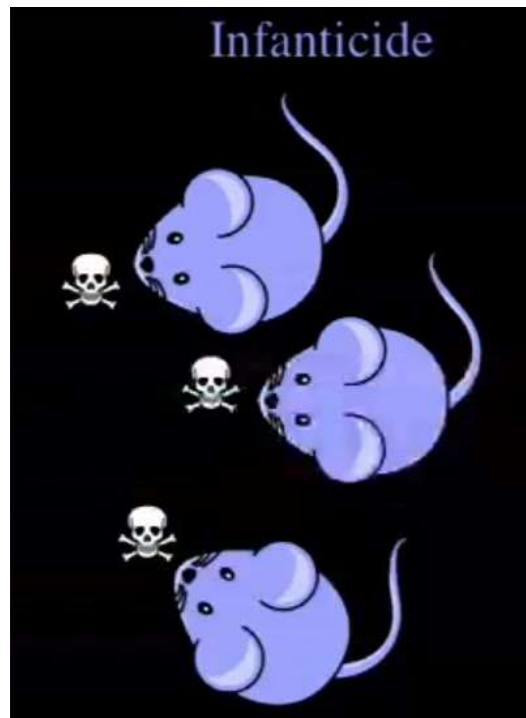
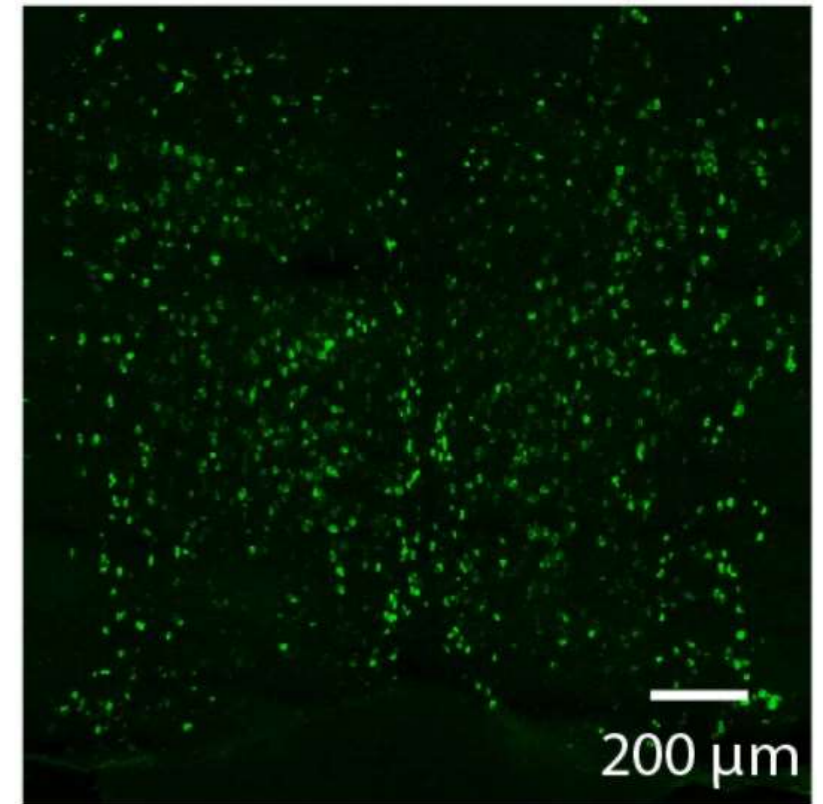
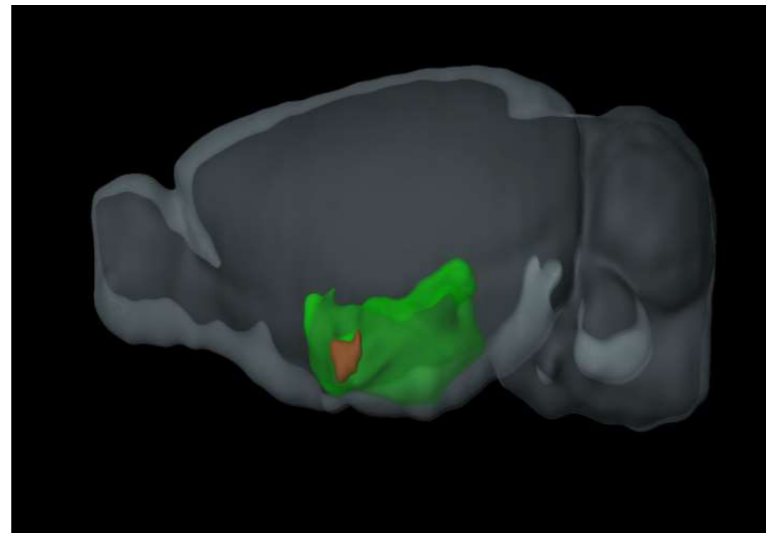

What other aspects of parenting do these neurons influence?

Parenting – Different Galanin+ neurons project to different areas

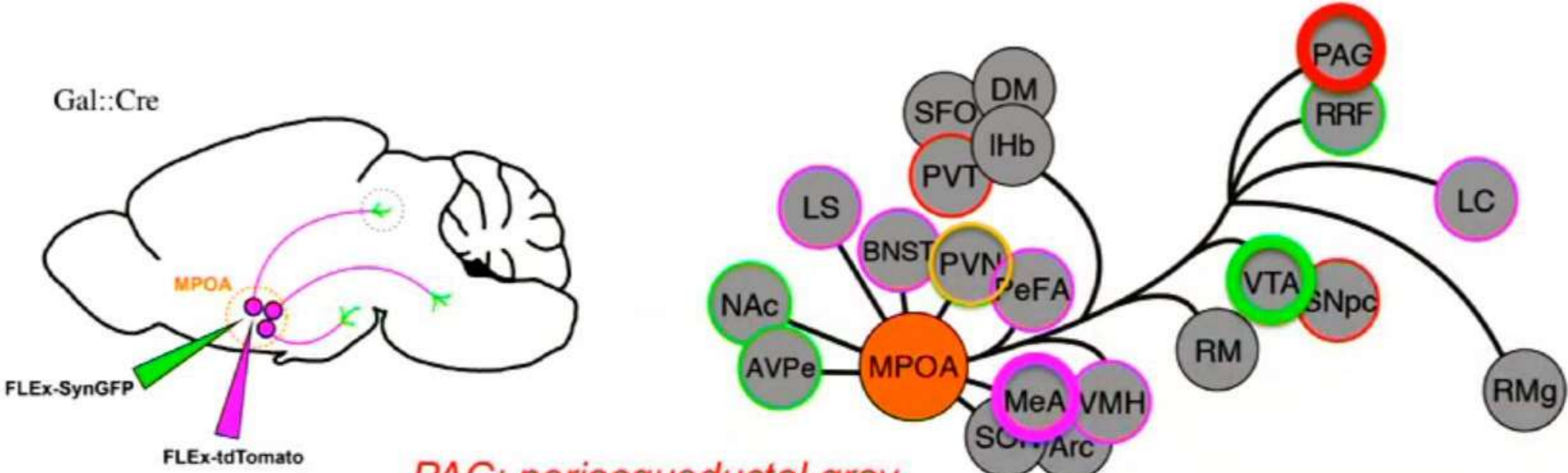

PAG: periaqueductal gray
VTA: ventral tegmental area
MeA: medial amygdala

- motivational
- motor
- social behaviors
- hormonal modulation

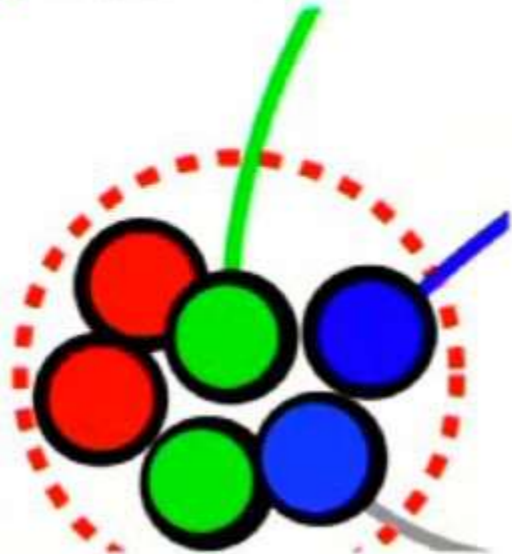
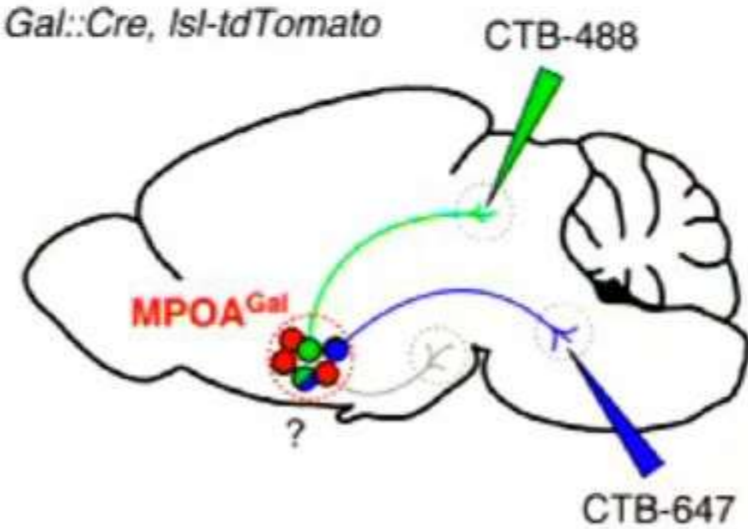

Gal neurons do not bifurcate

Dulac and colleagues

Parenting – Responses of Gal+ neurons projecting to different areas

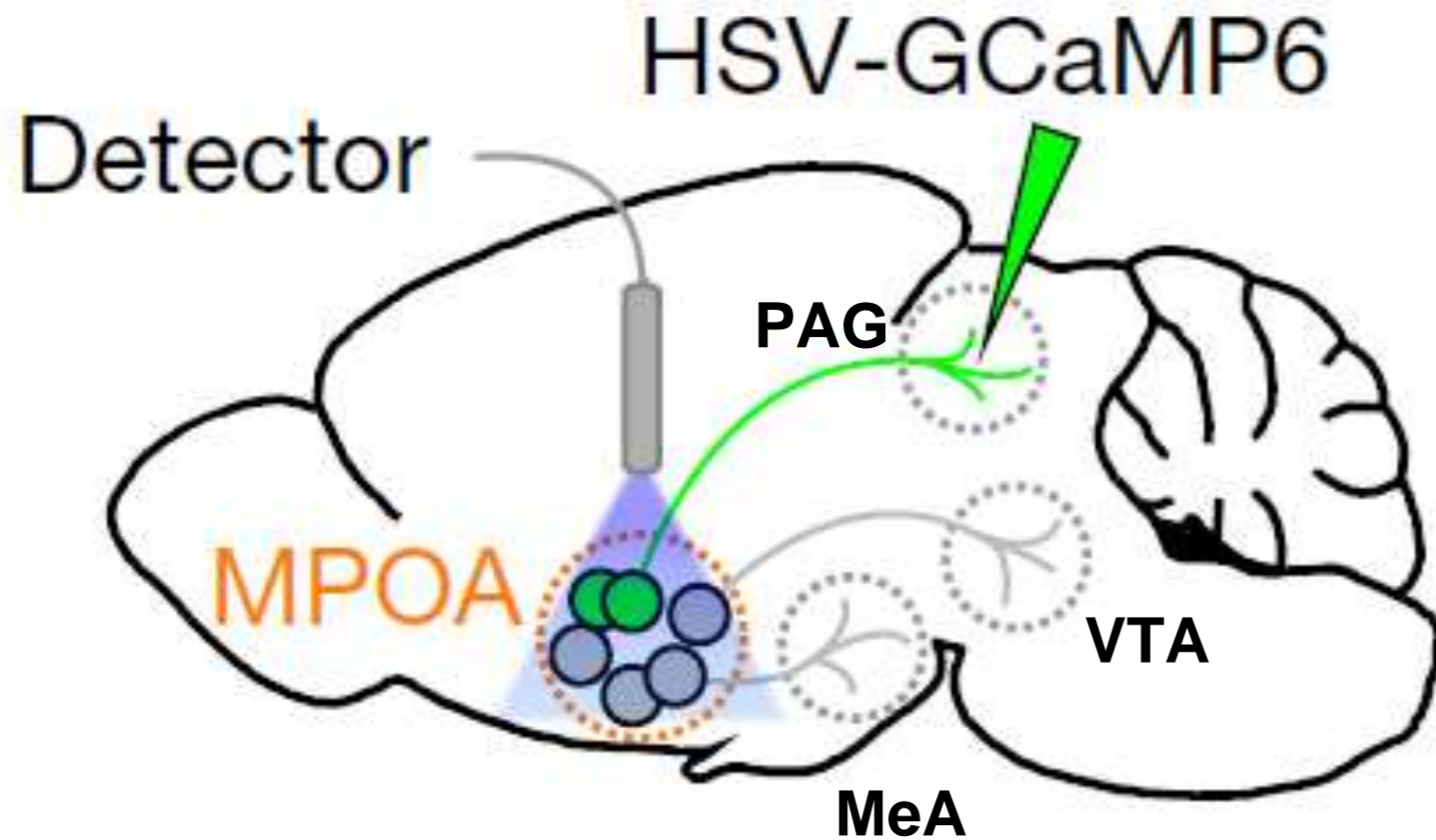

PAG – Periaqueductal Gray

VTA – Ventral Tegmental Area

MeA – Medial Amygdala

Parenting – Responses of Gal+ neurons projecting to different areas

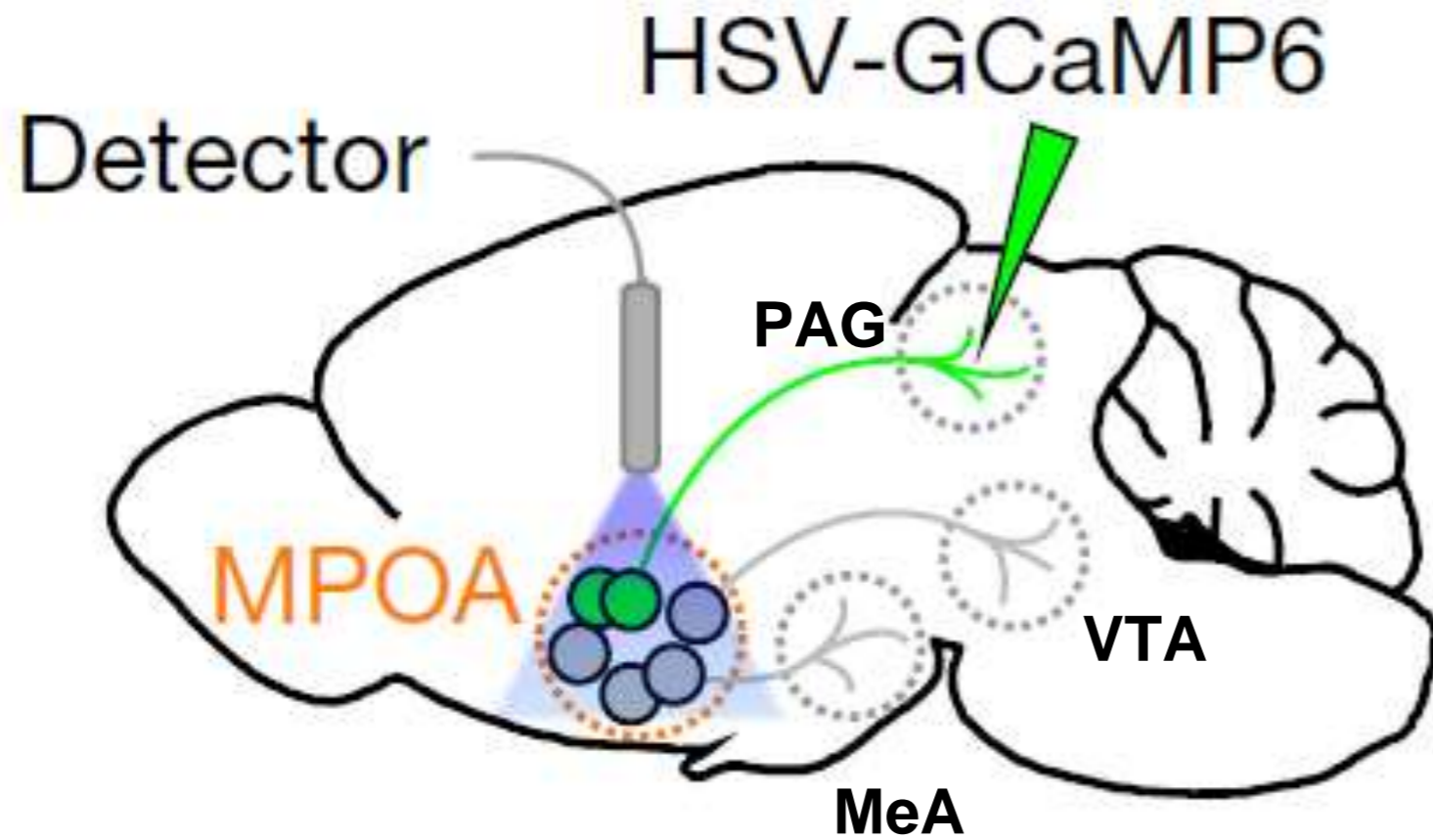

GCaMP6 – Ca²⁺ activity (spikes)

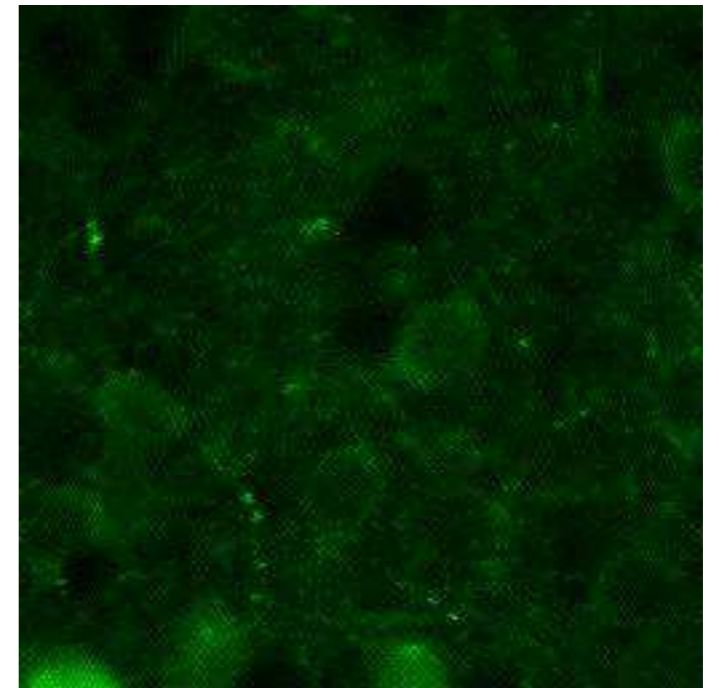

5x speed

Parenting – Responses of Gal+ neurons projecting to PAG

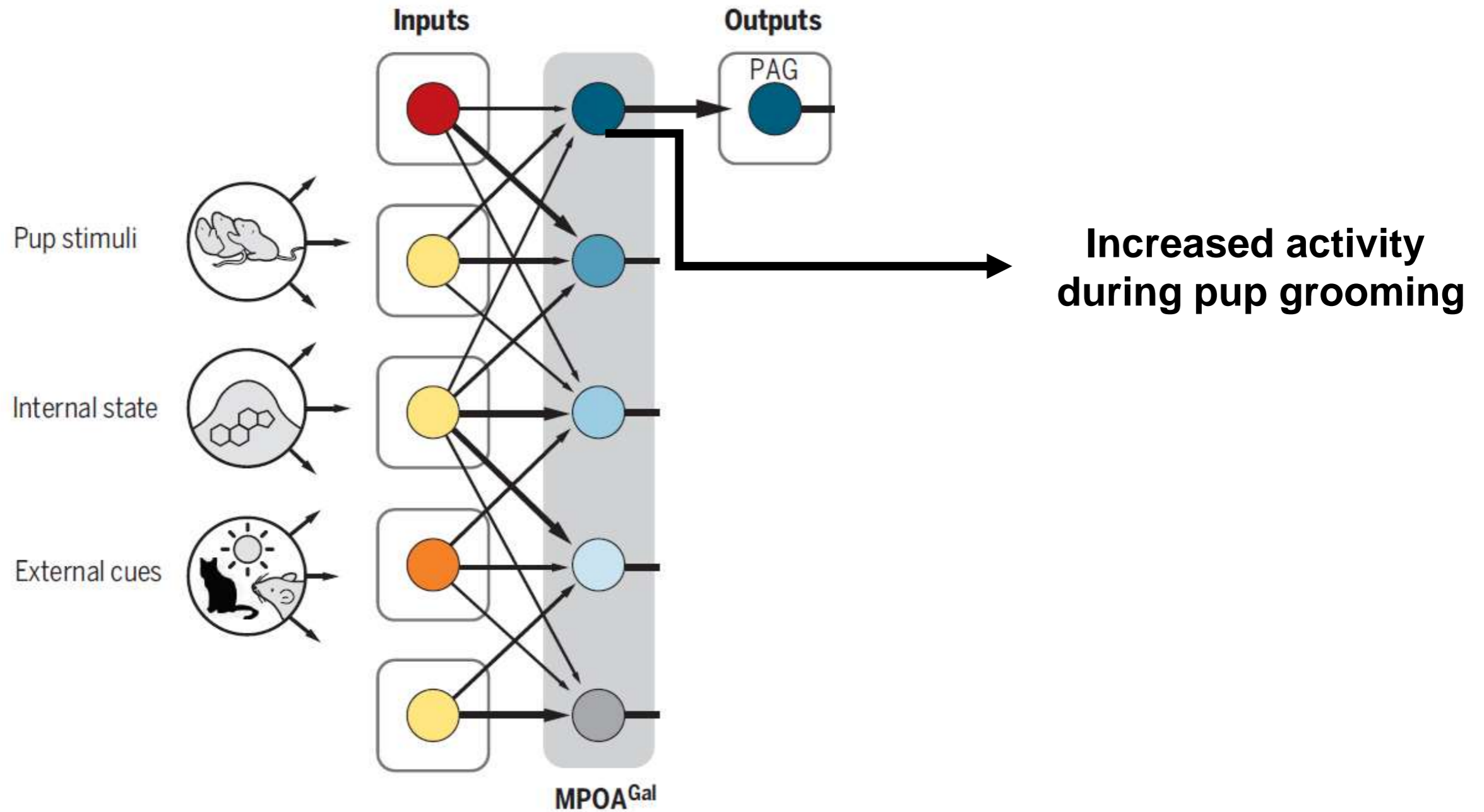

Parenting – Responses of Gal+ neurons projecting to MeA

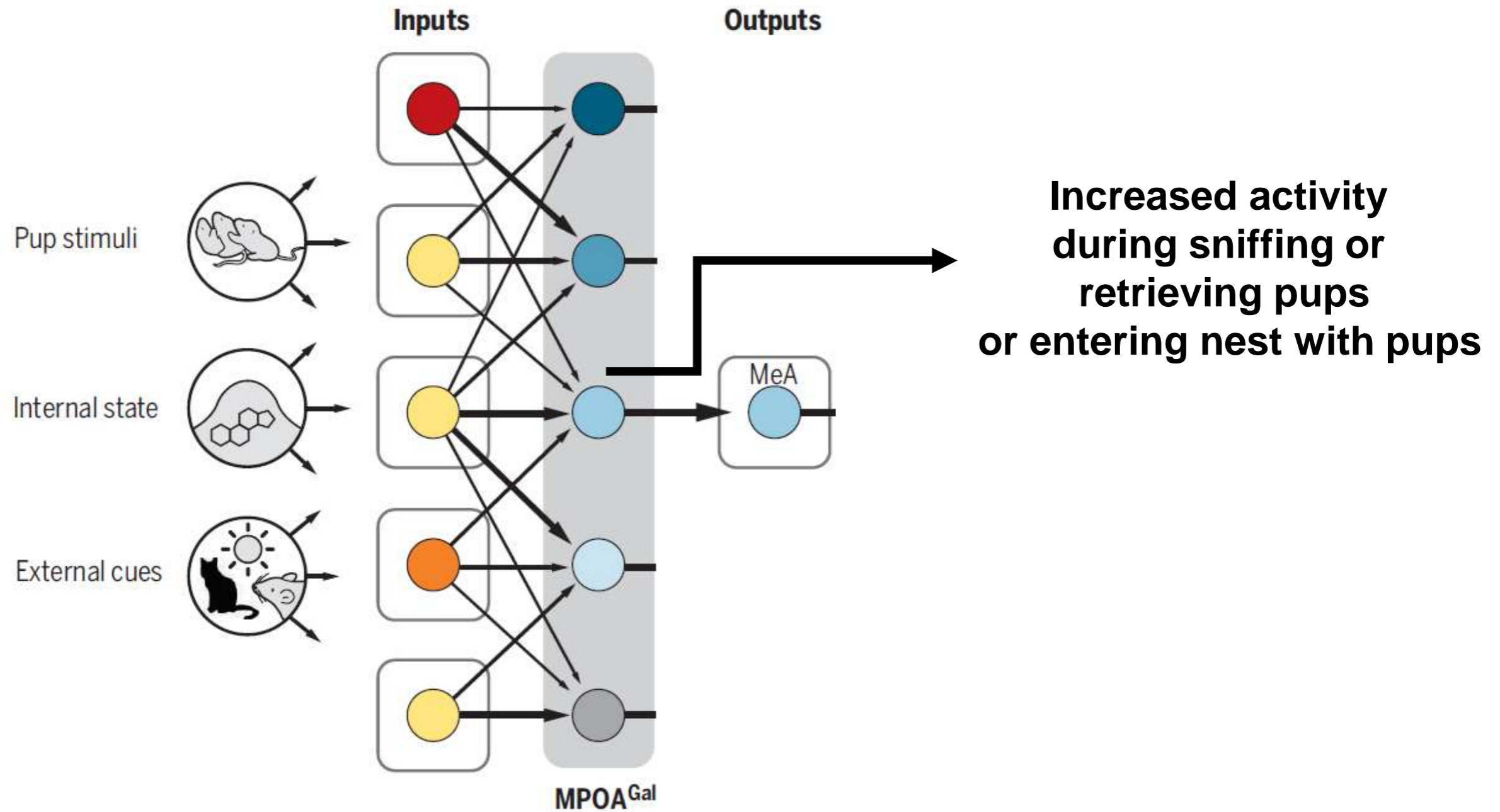

Parenting – Responses of Gal+ neurons projecting to VTA

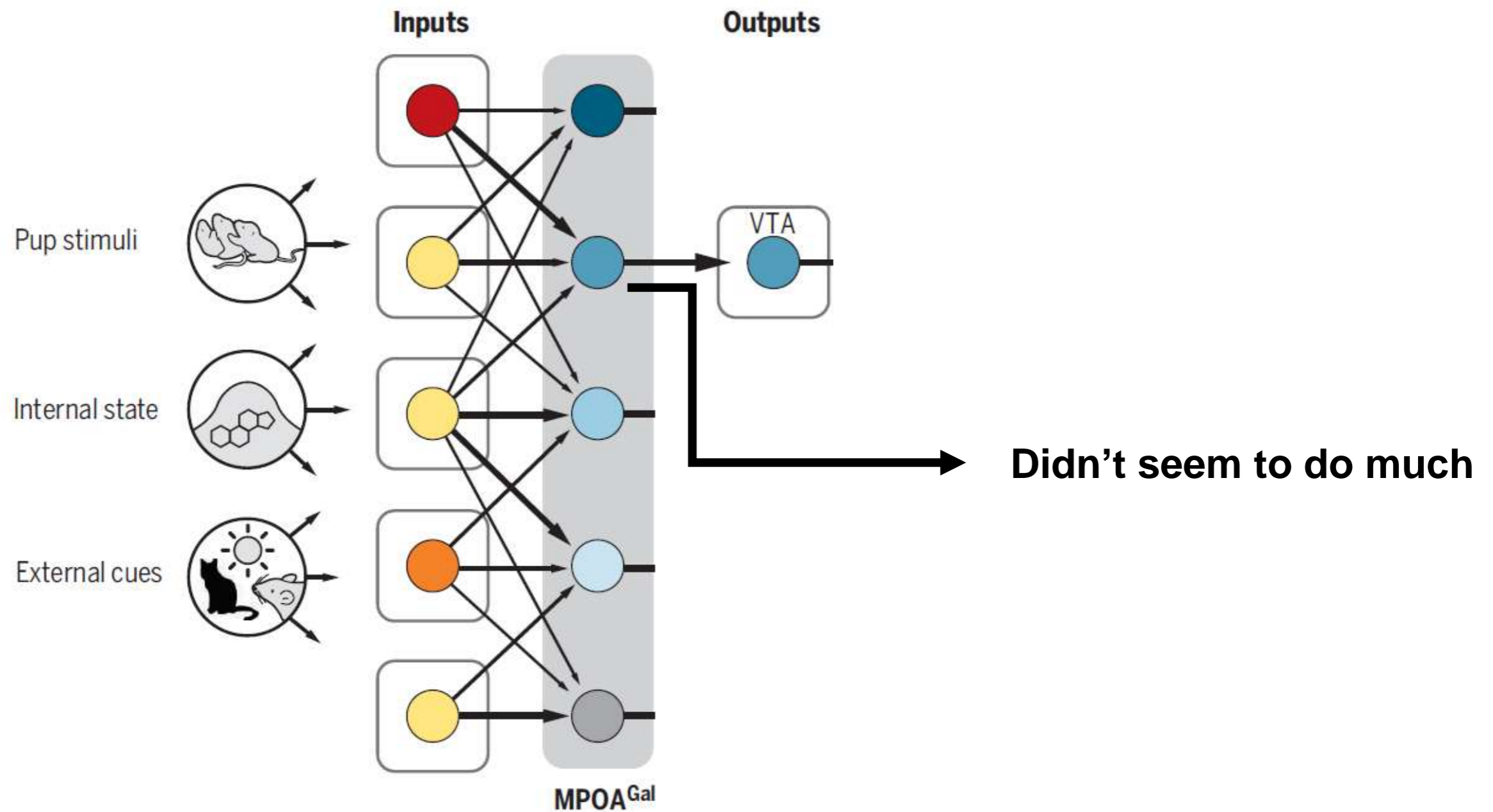

Parenting – Pup grooming

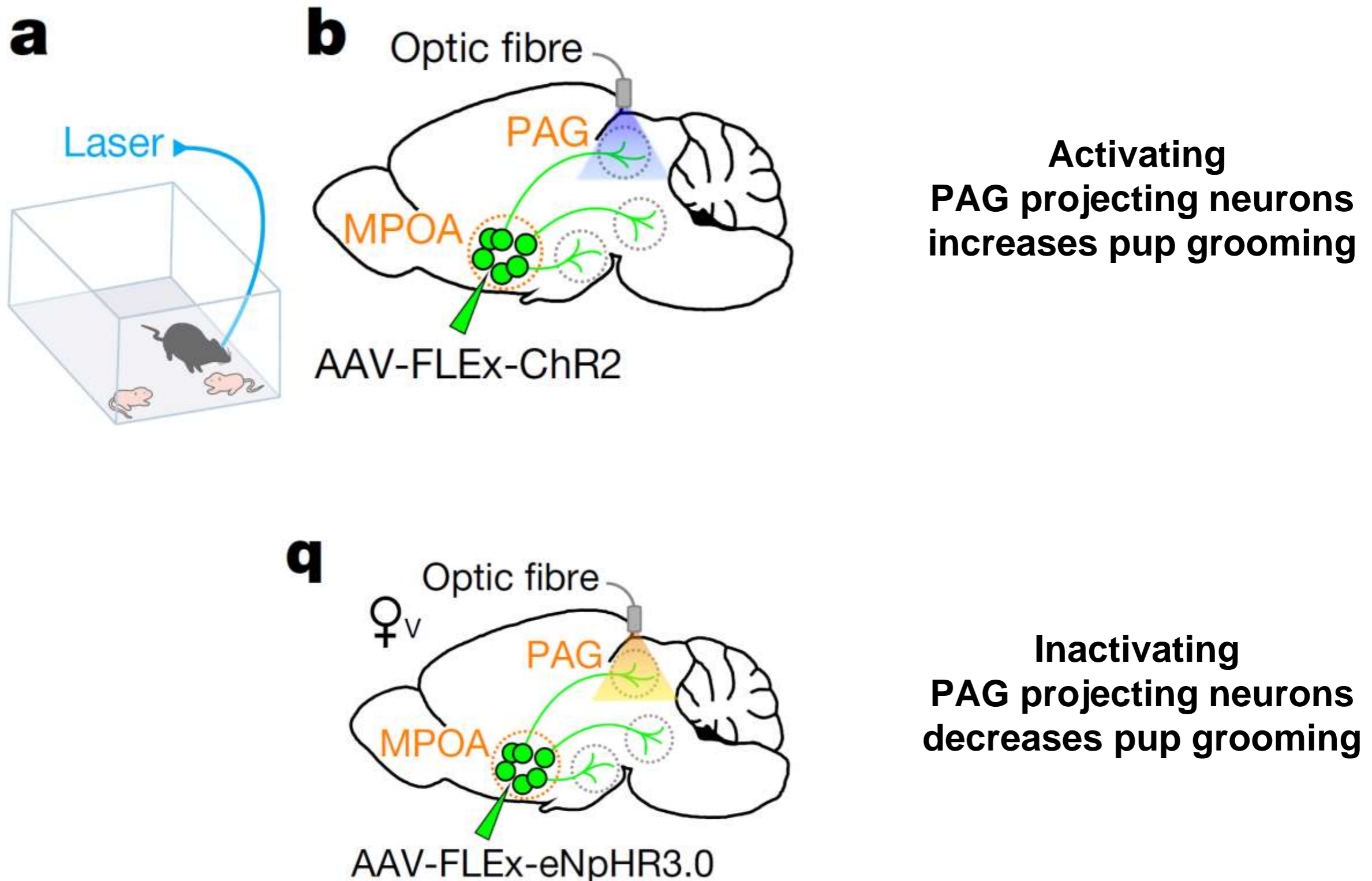

Parenting – Motivation to reach pups



Parenting – Motivation to reach pups

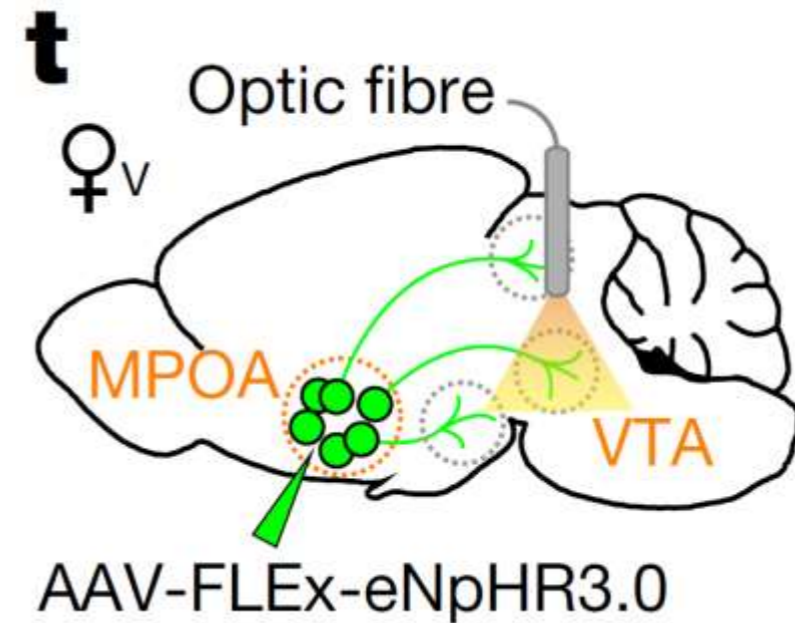
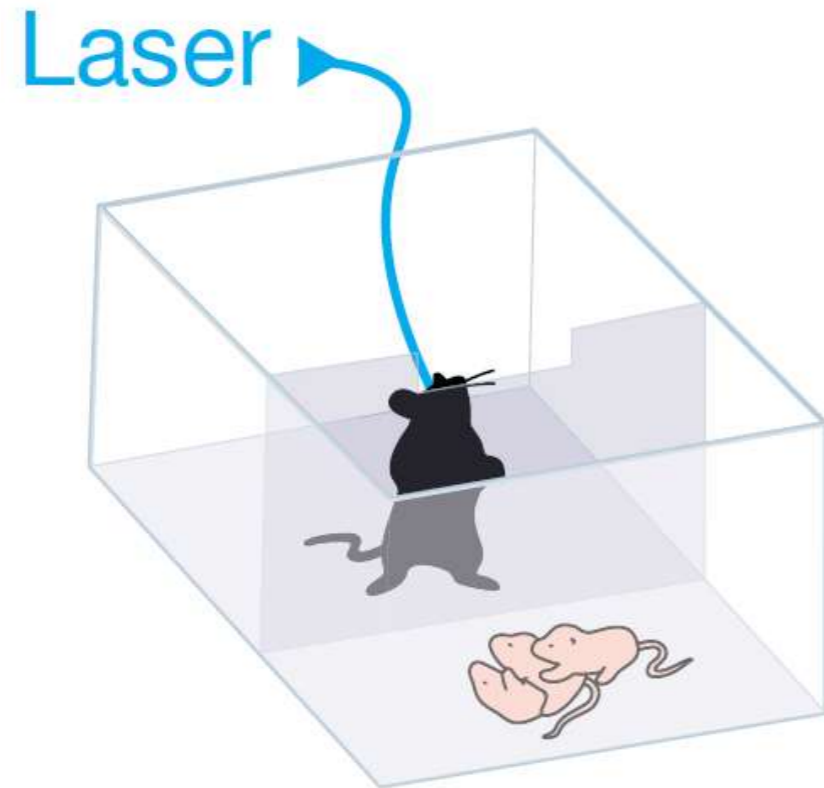

Inactivating VTA projecting neurons decreased barrier crossing

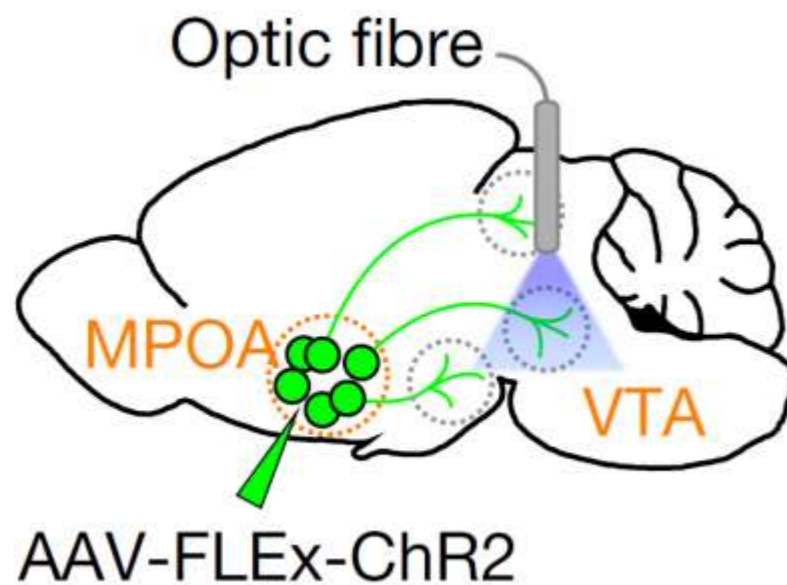

Activating VTA projecting neurons increased barrier crossing

But once they got there they might kill the pups, so it didn't make them parental overall

Parenting – Different aspects

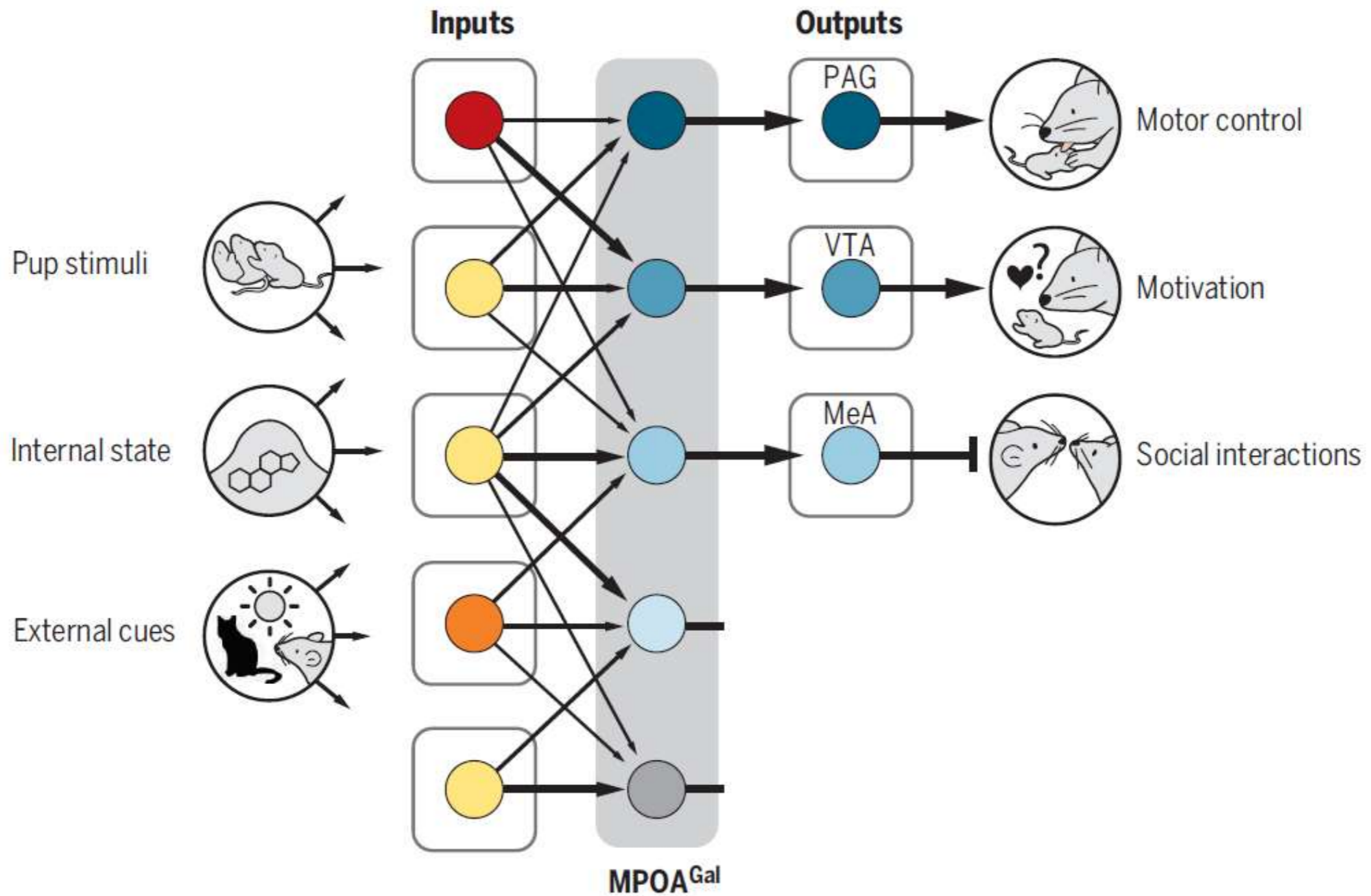

Questions

Parenting – Gal+ neurons from MPOA also project to OXT+ neurons in PVN

Periventricular Nucleus

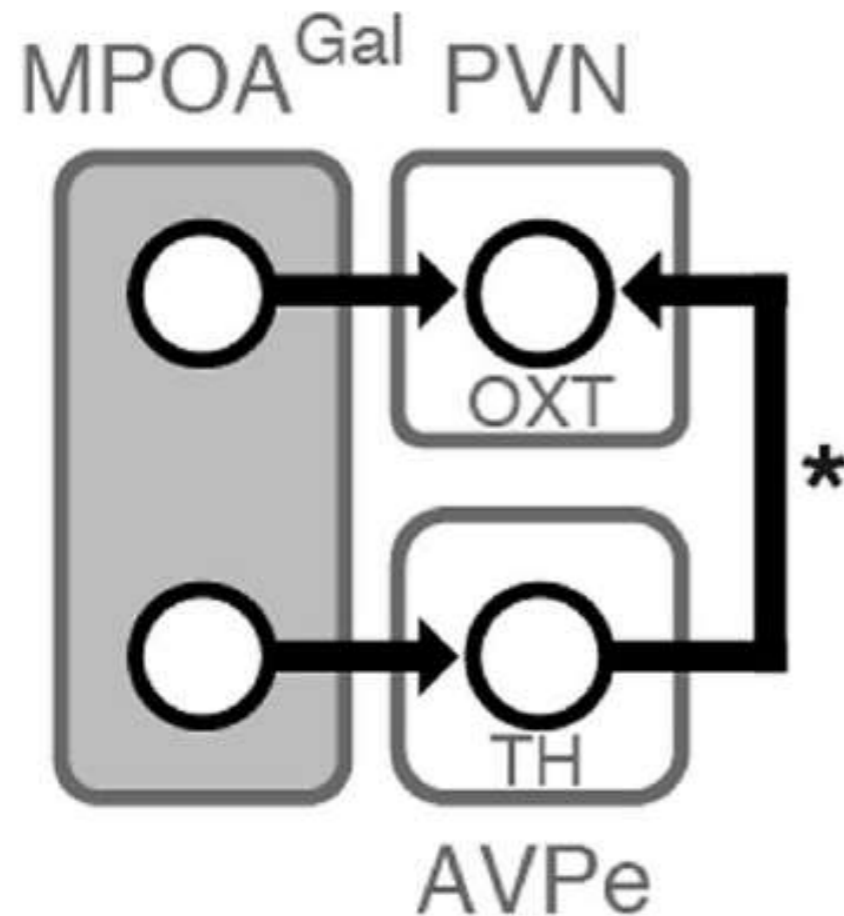

Anterior
Periventricular Nucleus

MPOA Gal+ neurons also project to PVN directly or indirectly – they project to oxytocin+ neurons in the PVN

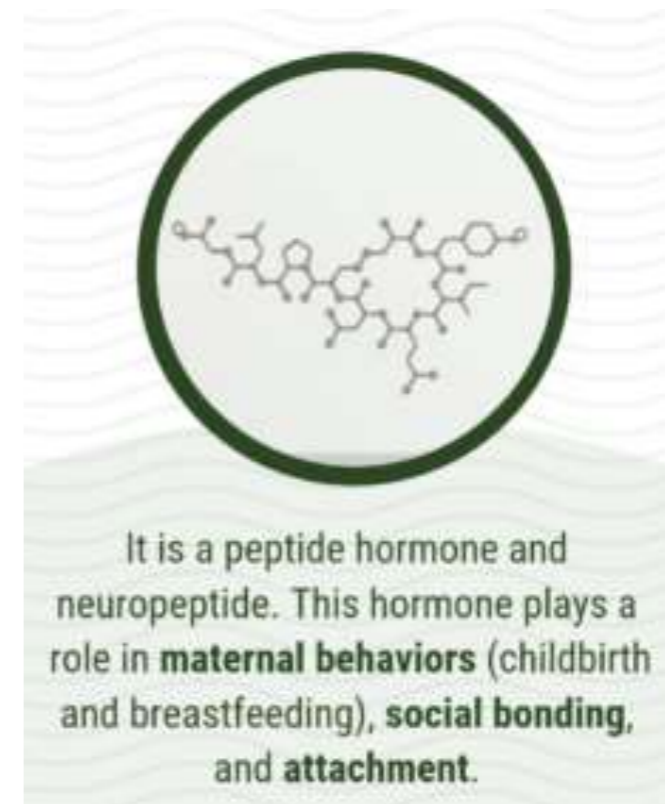

Oxytocin

Parenting – Carrying your young ones



Parenting – Carrying your young ones



Parenting – Observational learning of pup retrieval in virgin female mice

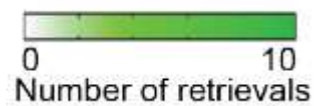
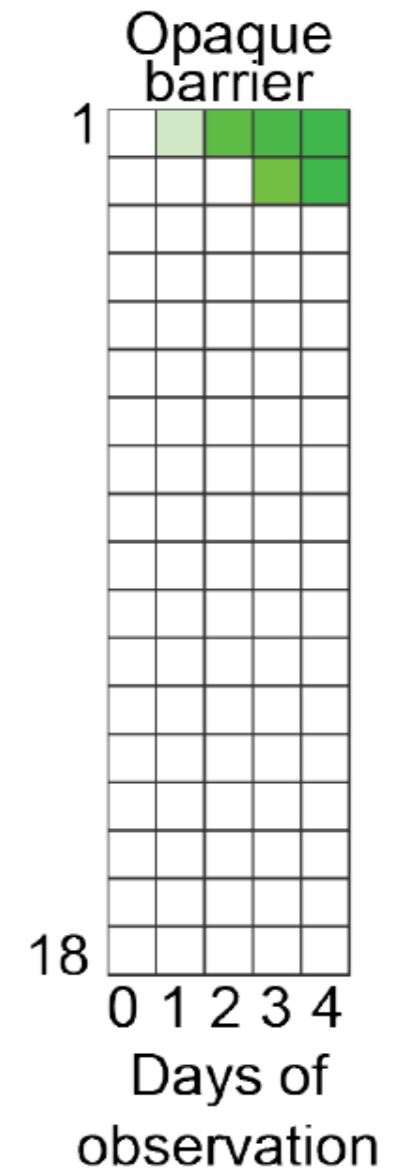
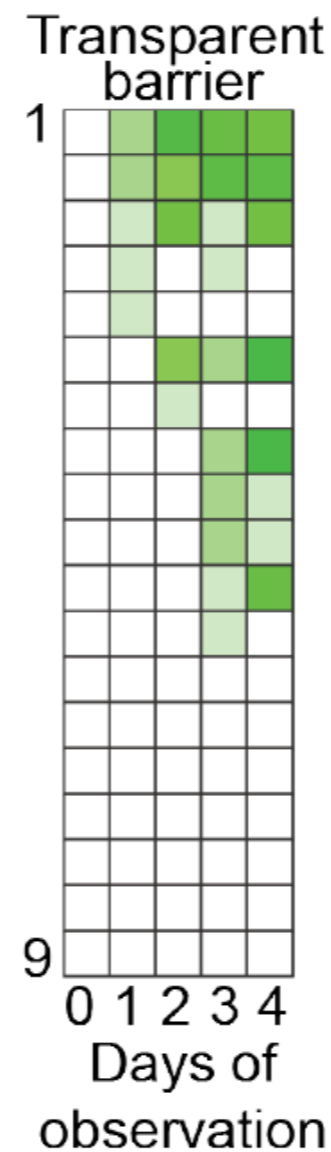
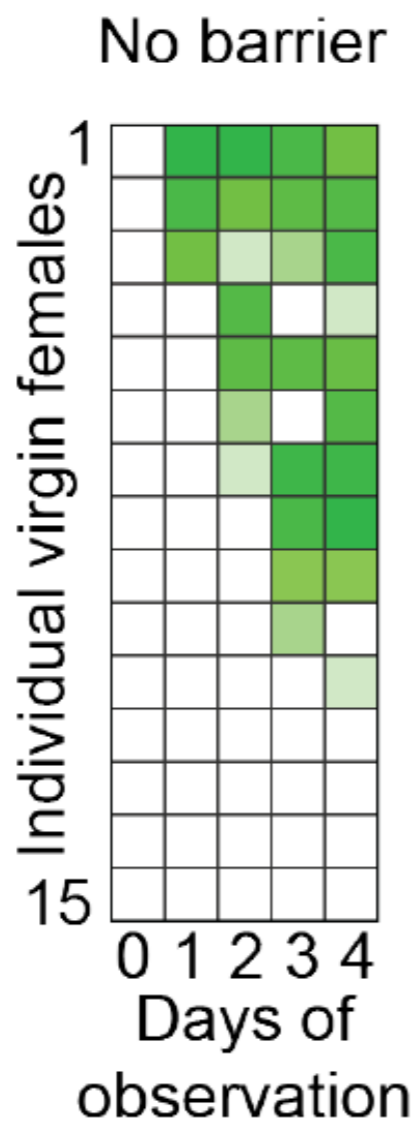
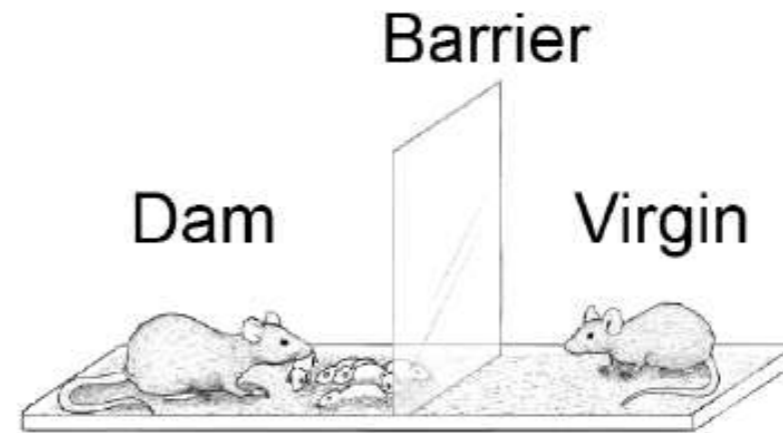
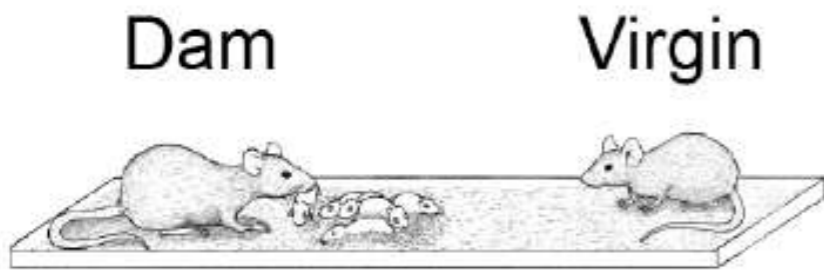

Parenting – OXT+ neurons in virgin females increased firing on observing retrieval of pups

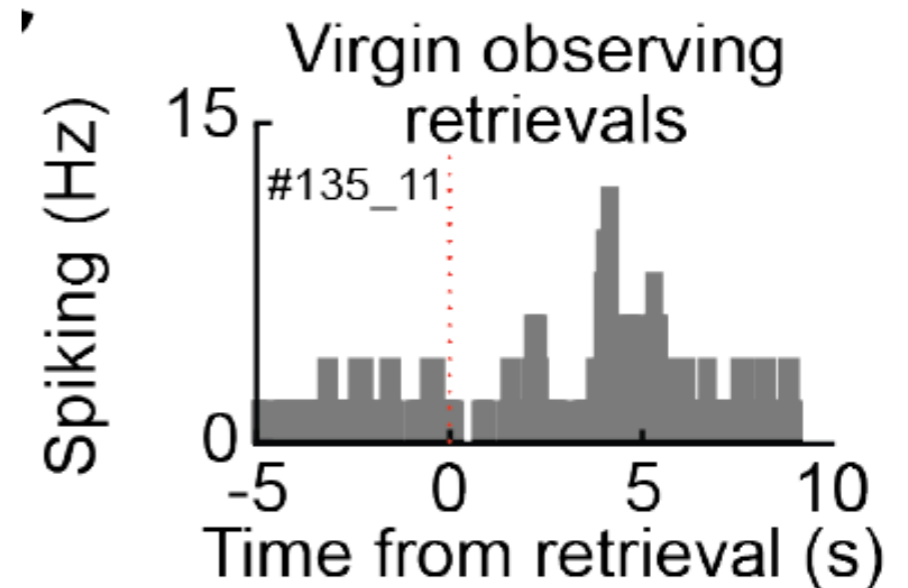
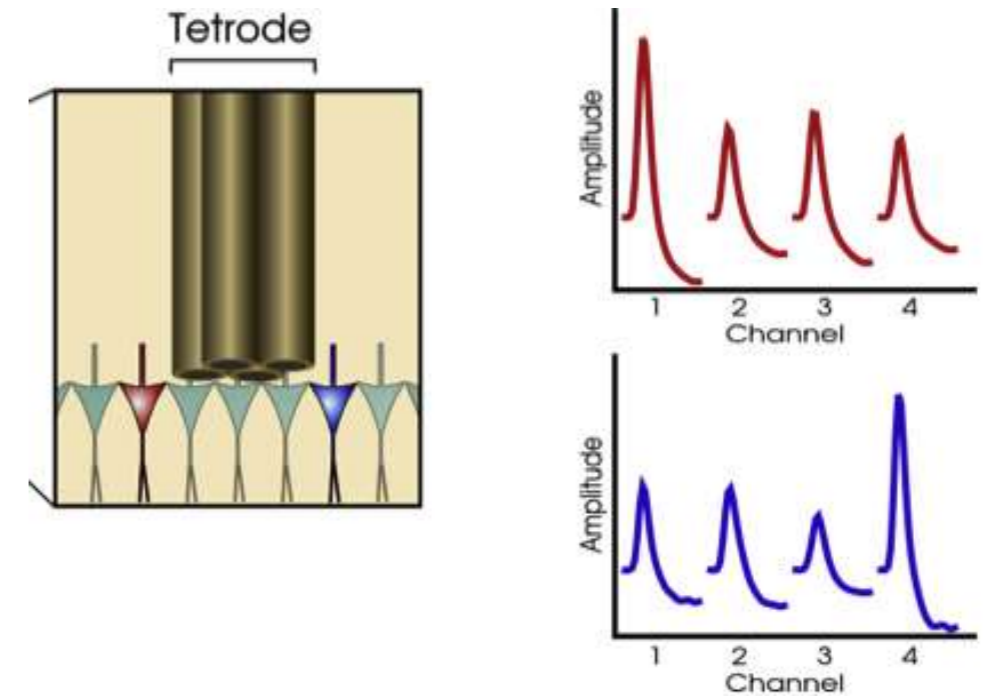
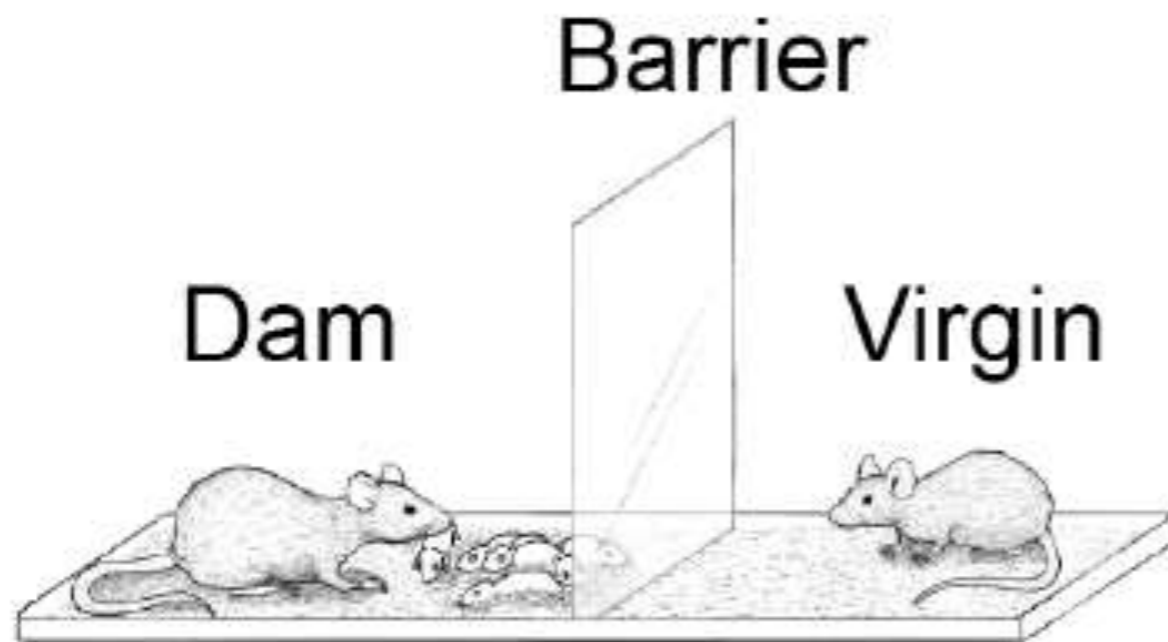

Parenting – Oxytocin neuron activation makes learning pup retrieval for virgin females faster

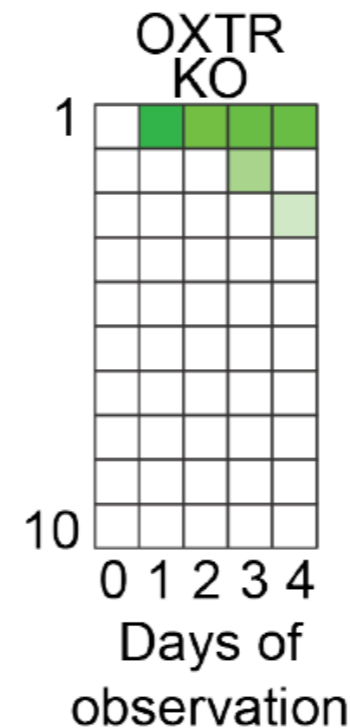
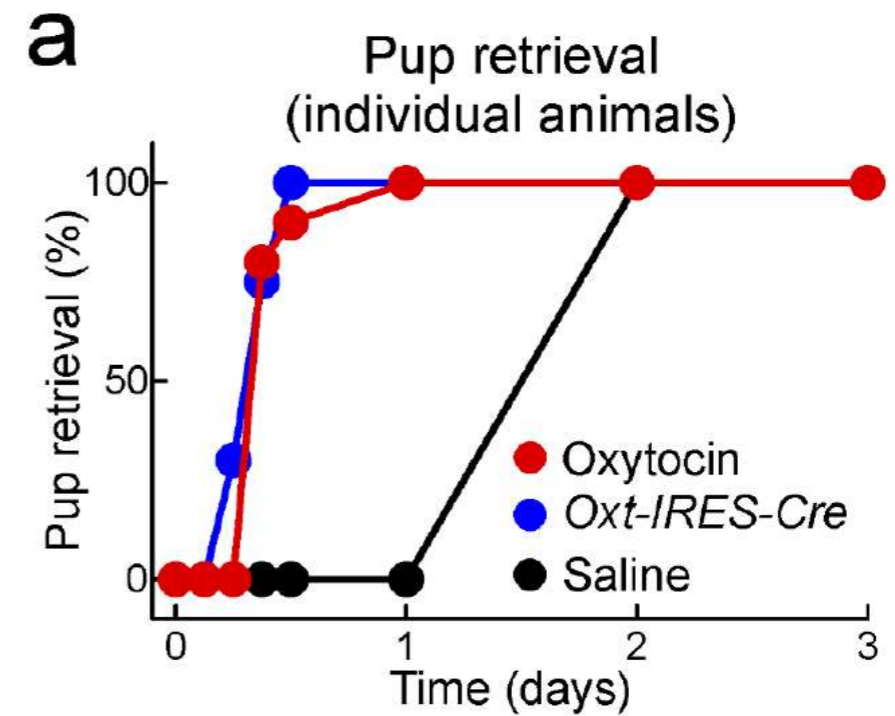
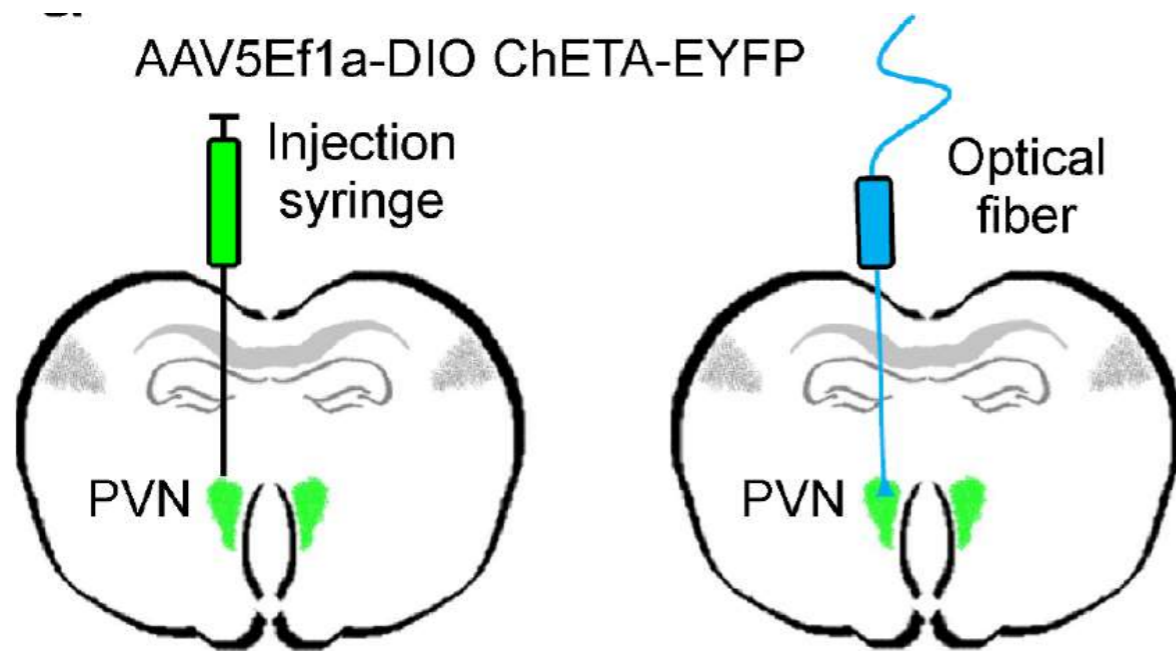

Oxytocin receptor knockout virgin mice do not learn pup retrieval

Deconstructing parenting

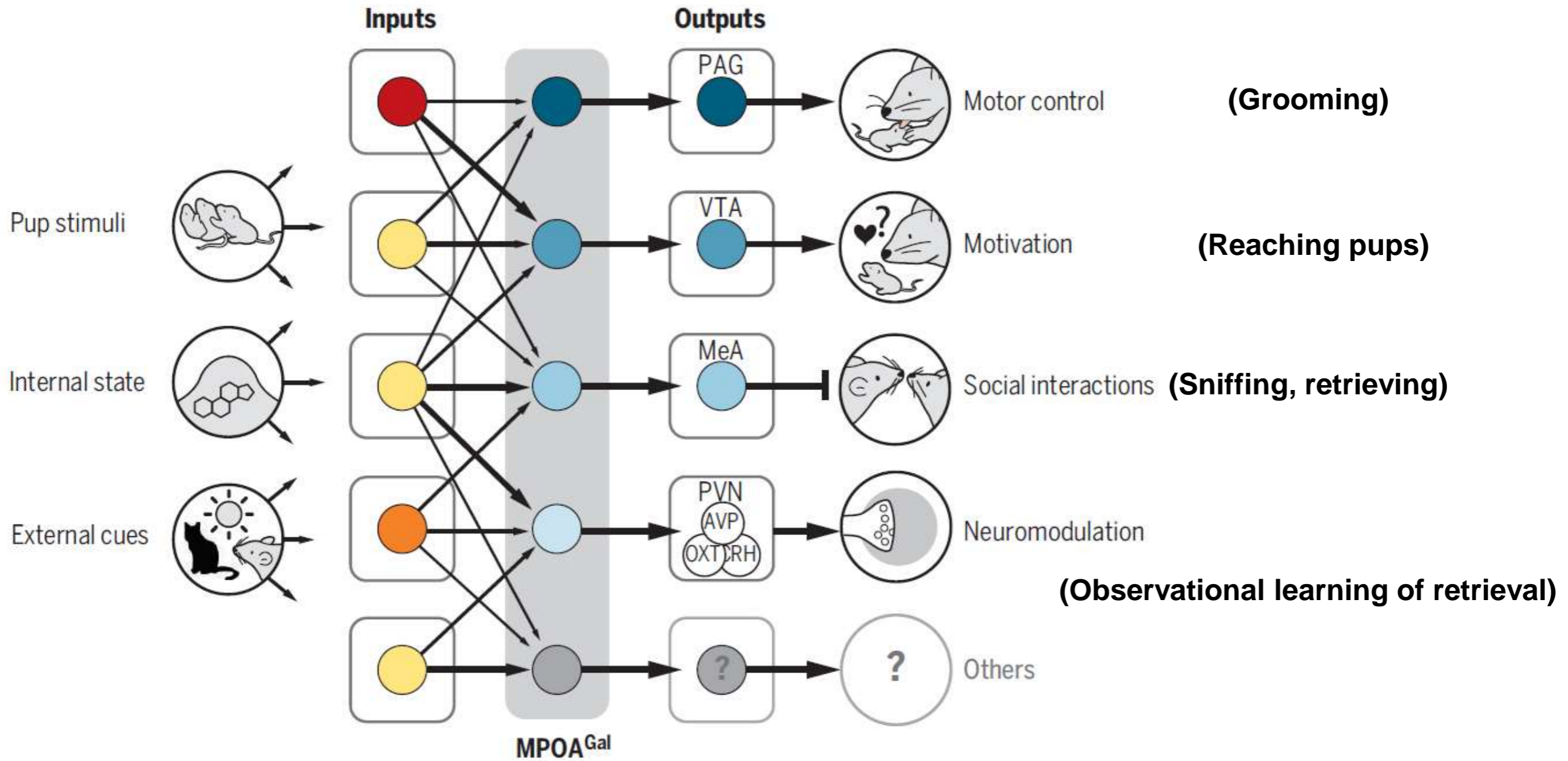

From aggression to parenting



Social Bonding



Bolivian Titi Monkeys



Social Bonding – Prairie voles like spending time with their partners



Montane Voles



**Prairie Voles
(pair bonds)**

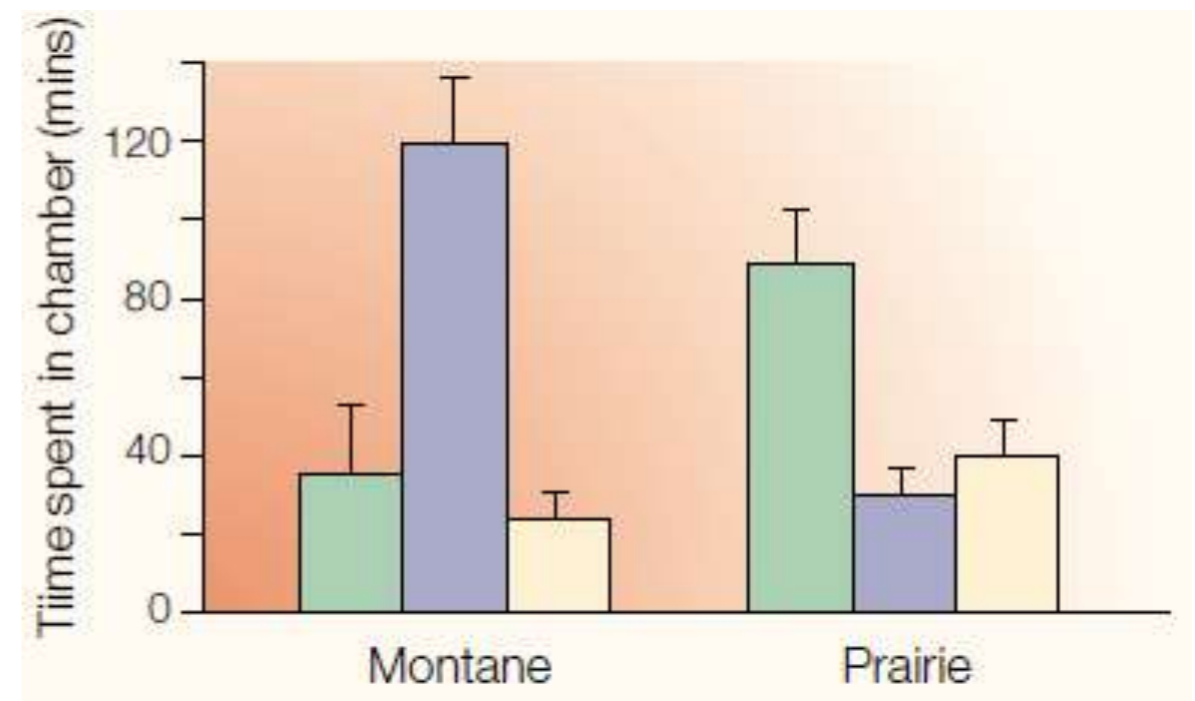
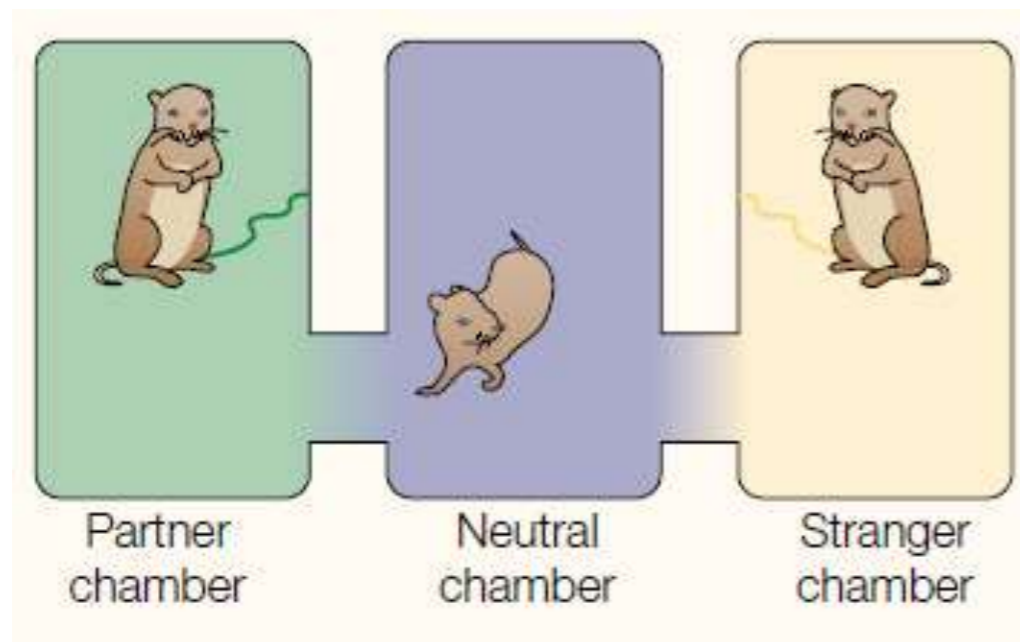

Social Bonding – More OXT receptors in prairie voles



Montane Voles



**Prairie Voles
(pair bonds)**

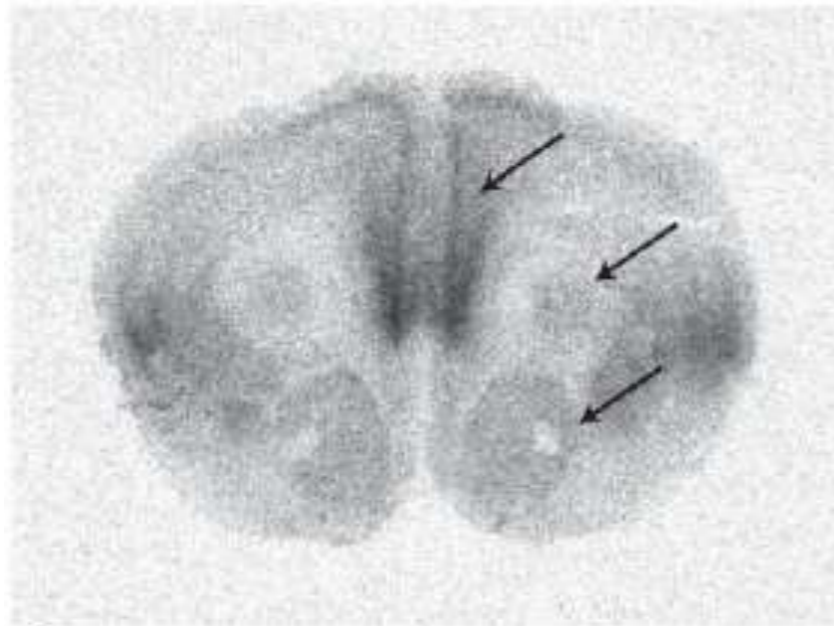

Young and colleagues

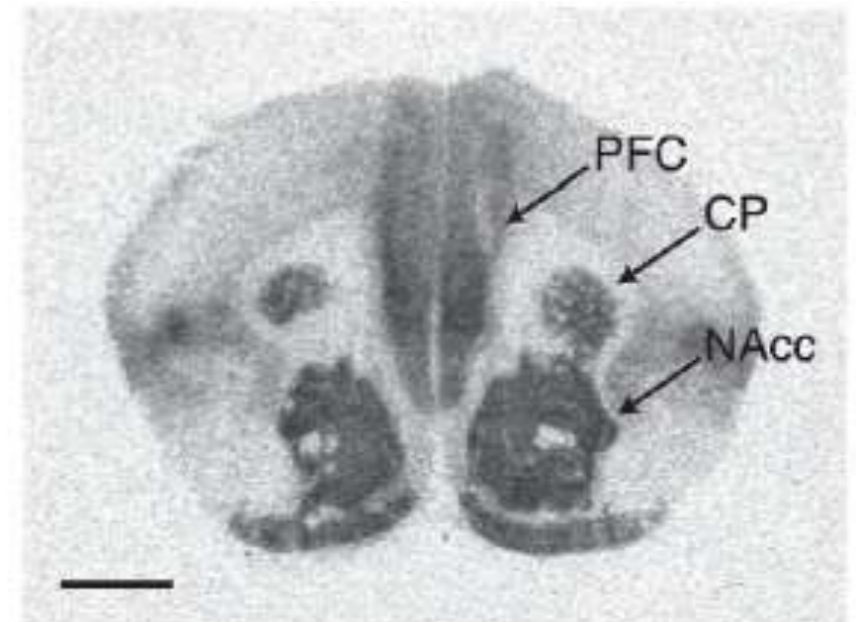

Social Bonding – Blocking OXT receptors in PFC reduces comforting (Allogrooming) of partners and siblings



Prairie Voles

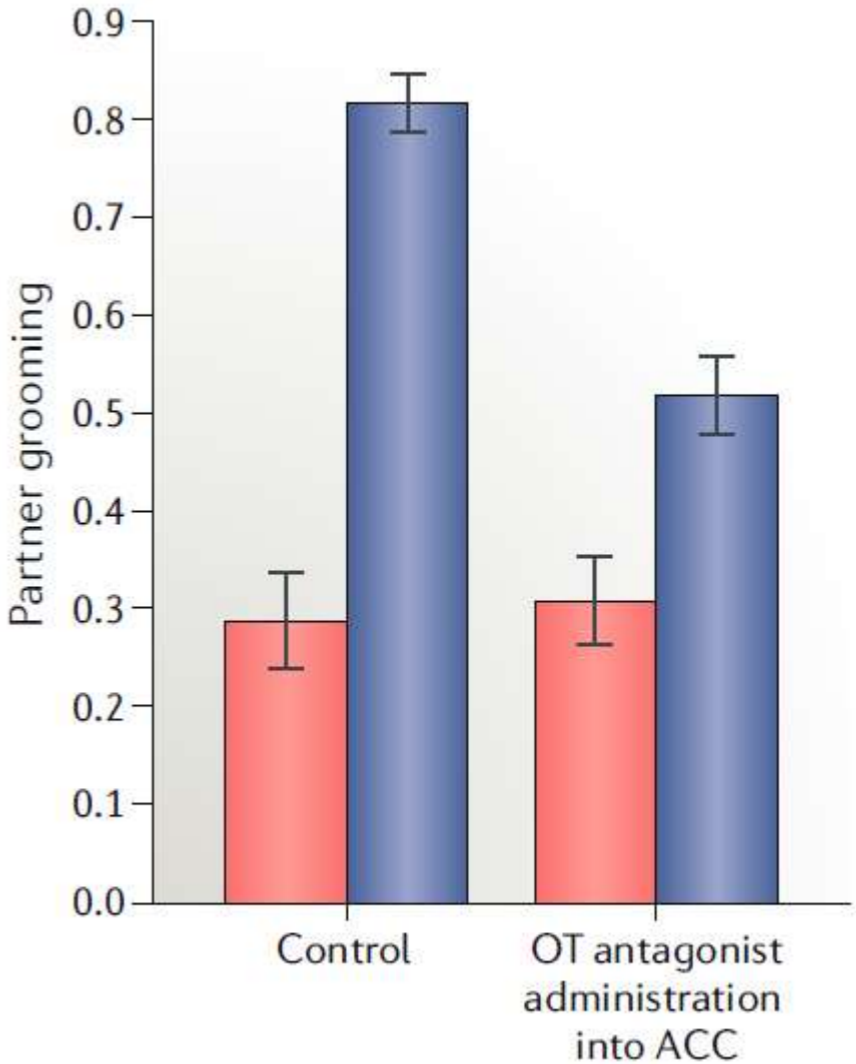
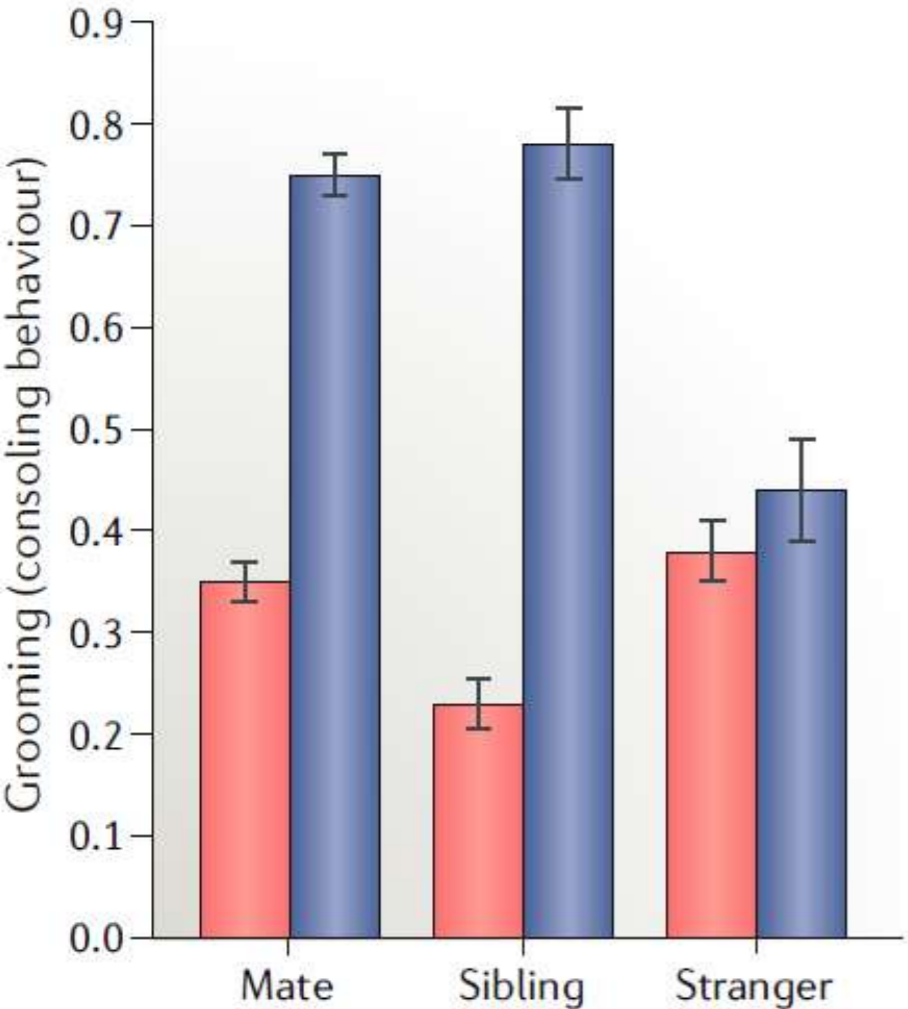





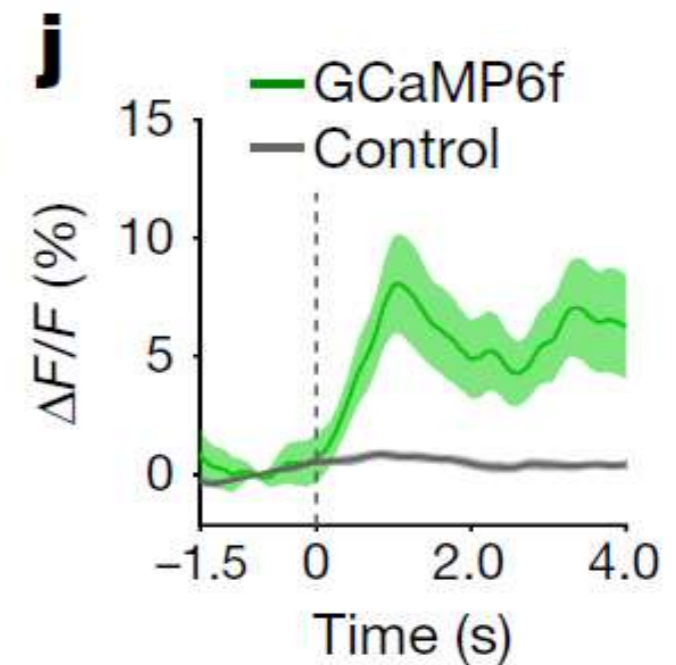
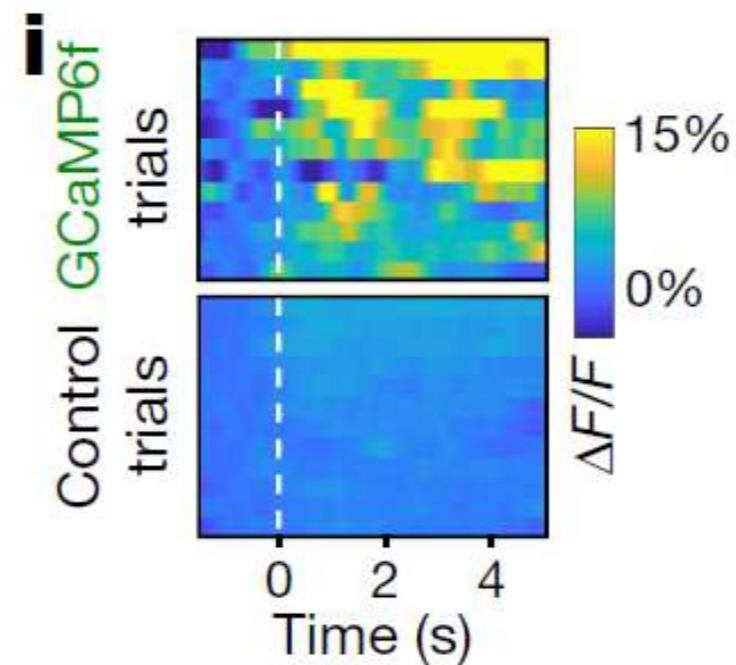
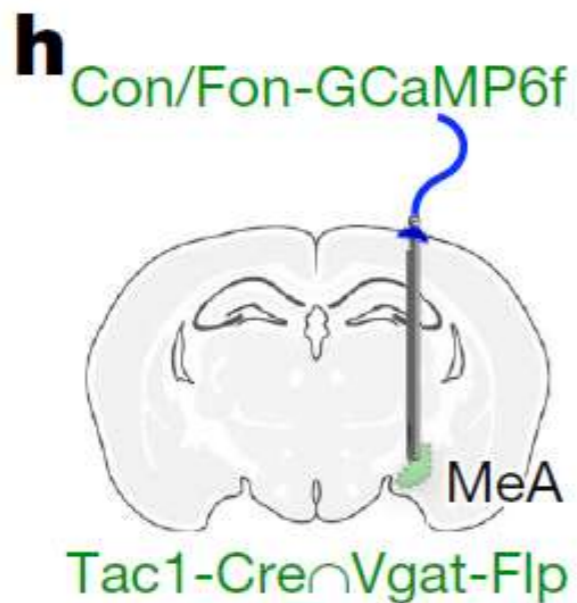
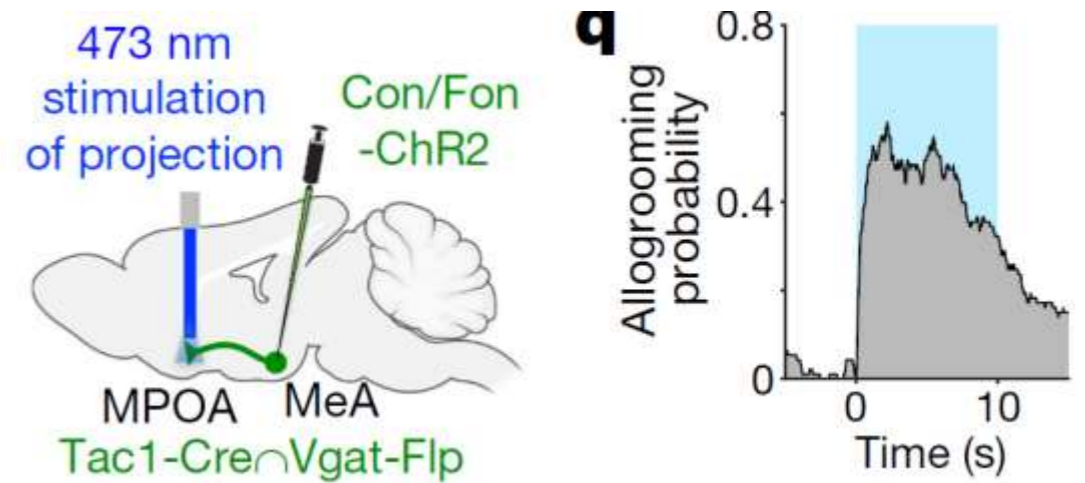
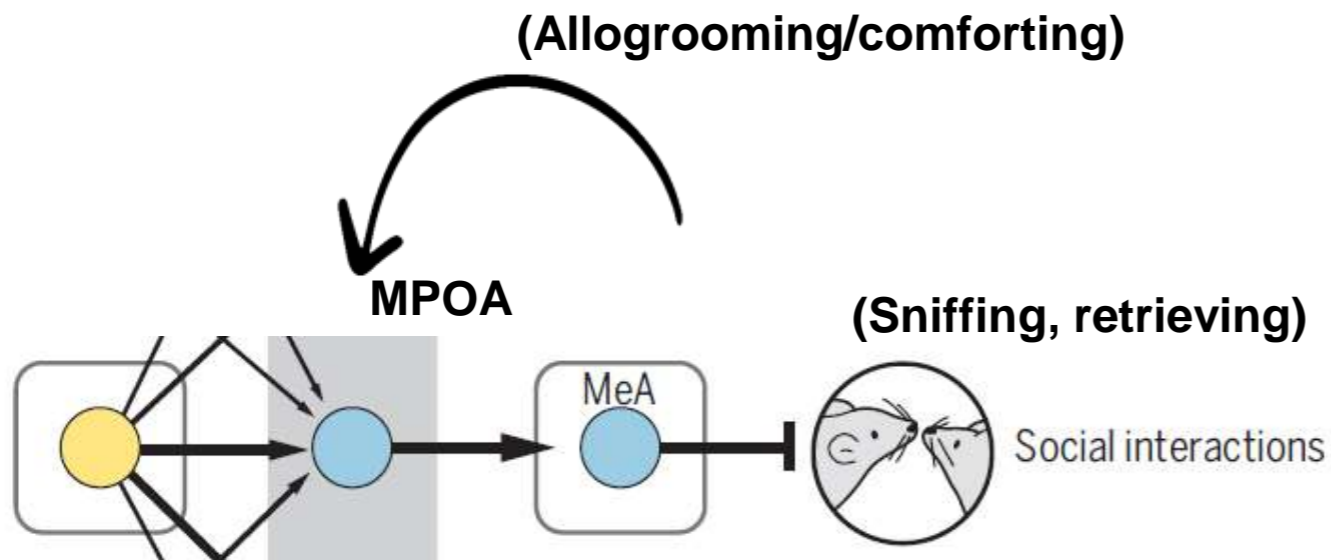

Before stressor After stressor

MEA to MPOA - Allogrooming



Social Hierarchy – Animal societies have structure and hierarchy



Type of adult bee	What they do	How many in a honey bee colony	How many in a bumble bee colony	What they look like in a honey bee colony	What they look like in a bumble bee colony
Queen	Lay eggs	1	1		
Worker	Take care of larvae, build and clean nest, forage	10,000-50,000	Less than 50 to over 400, depending on species		
Male	Leave nest to mate, then die	100-500	0-50, depending on species and season		

Social Hierarchy – Tube Test

Left

Right



1/3 X speed

T. Zhou et al/Science 2017

SN

Social Hierarchy – Consistent with other tests

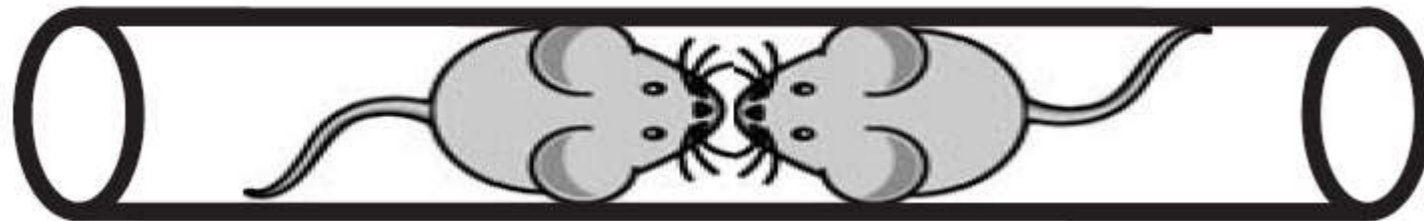

■ Cold floor
■ Warm spot

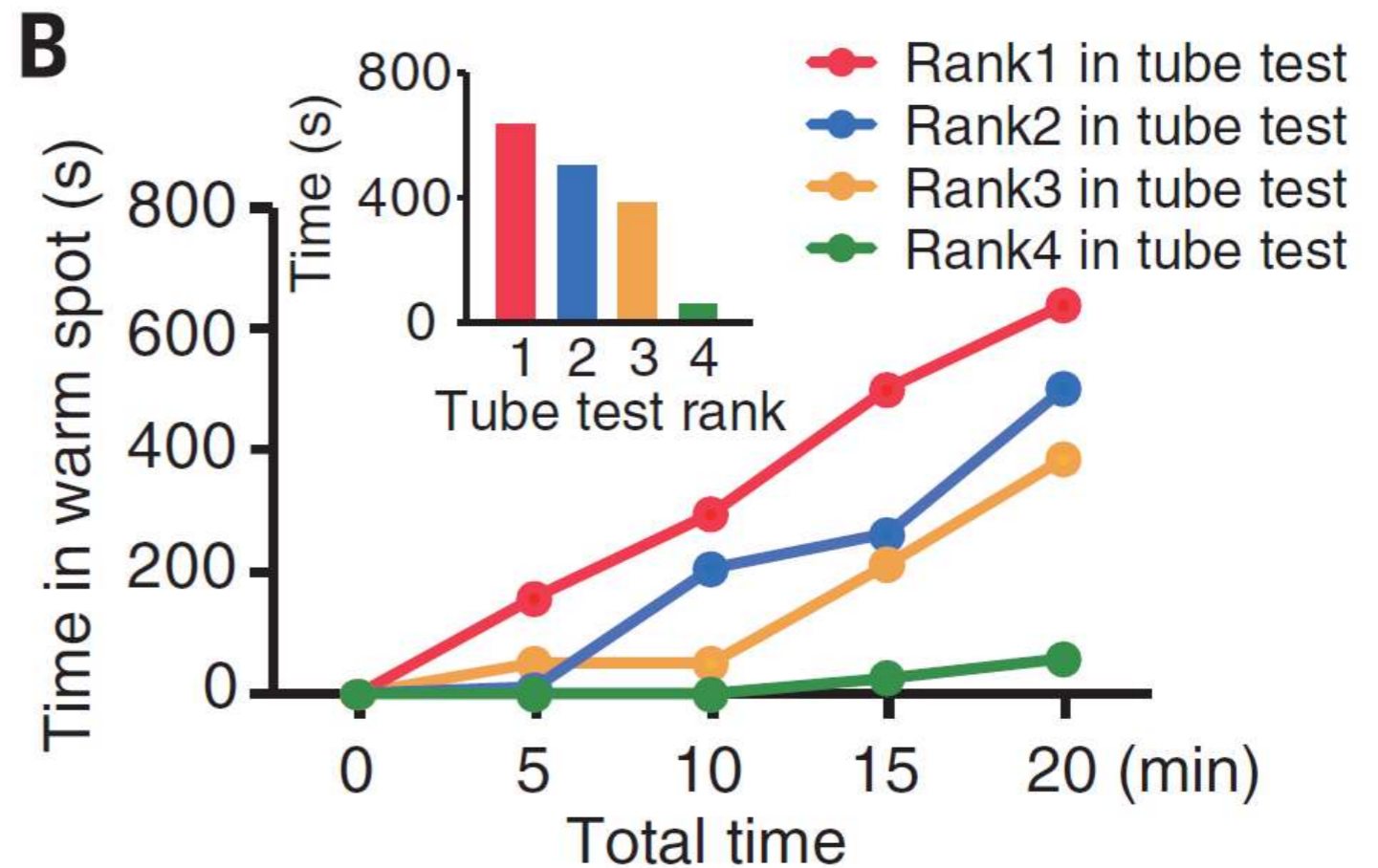

Social Hierarchy – Neural recording in medial prefrontal cortex

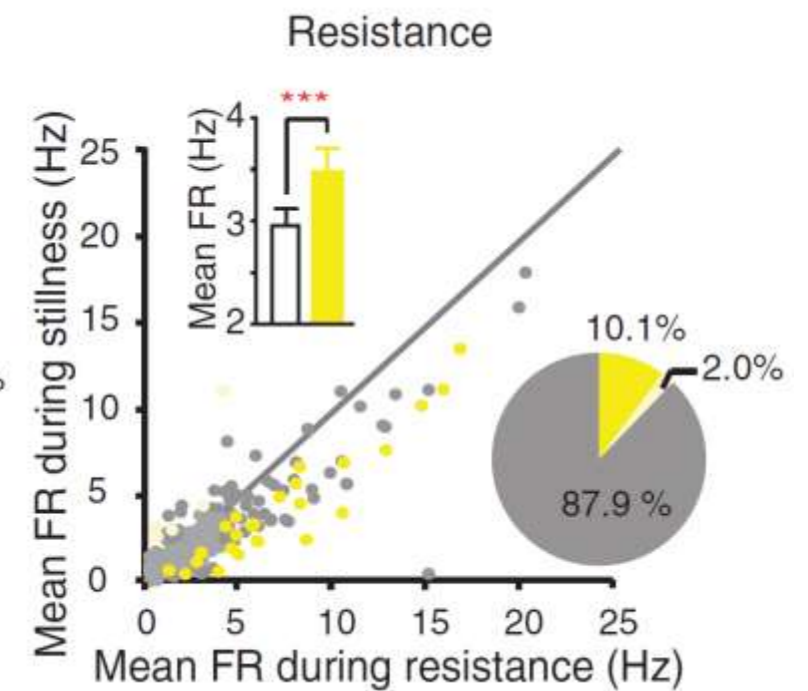
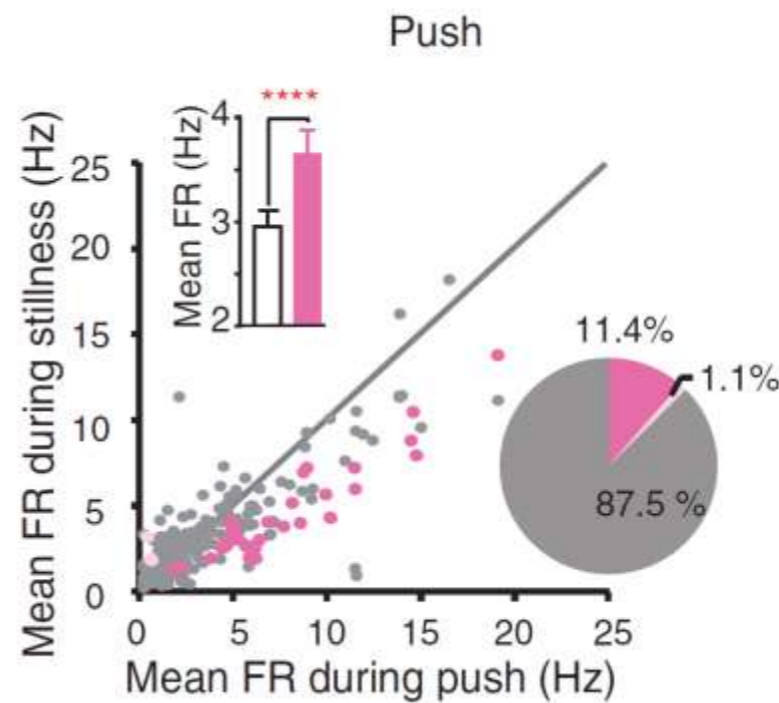
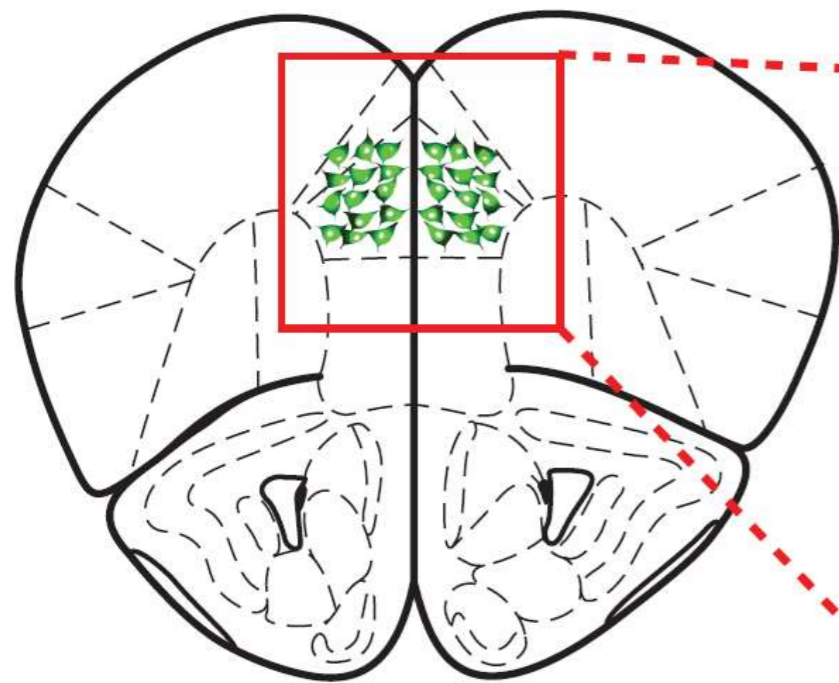

Neurons in the medial prefrontal cortex increased their firing rate during pushing or resisting

Social Hierarchy – Modulation of medial prefrontal cortex (mPFC) neurons changes dominance

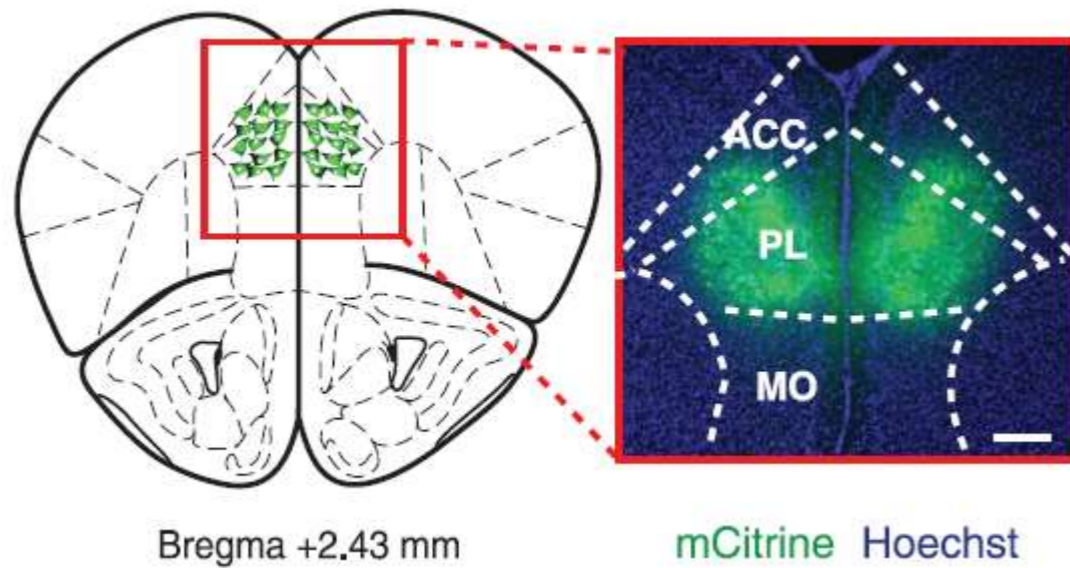

ACC/PL/MO-
sub regions of mPFC

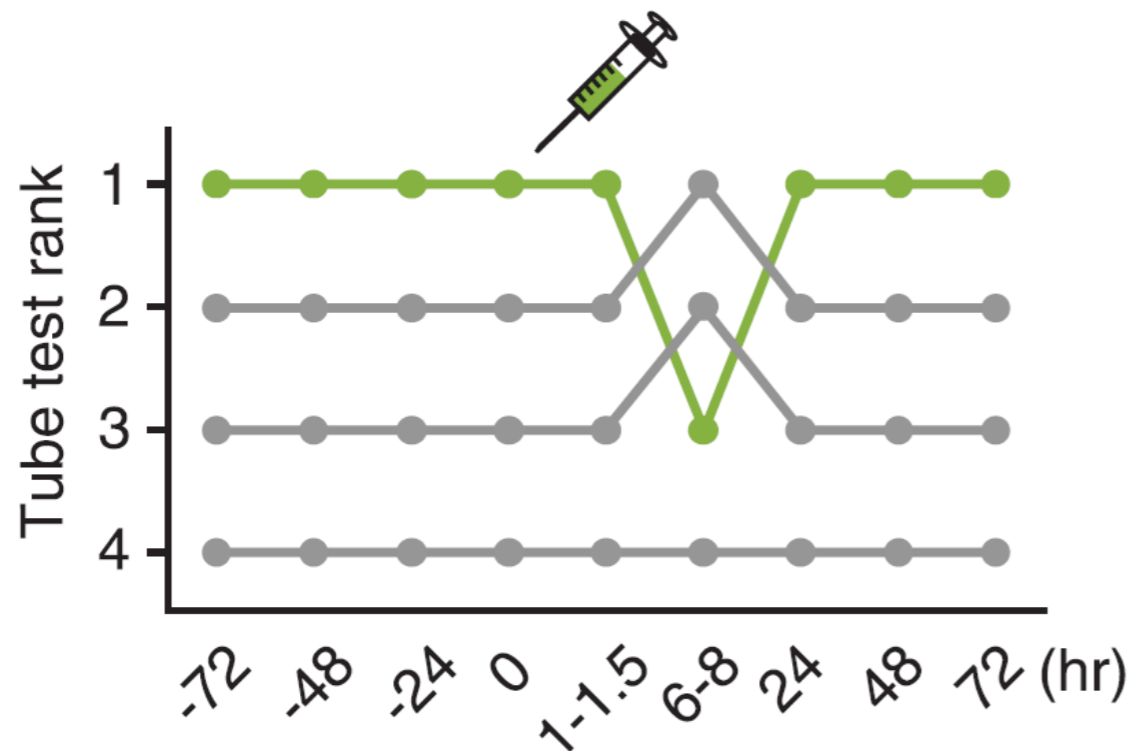
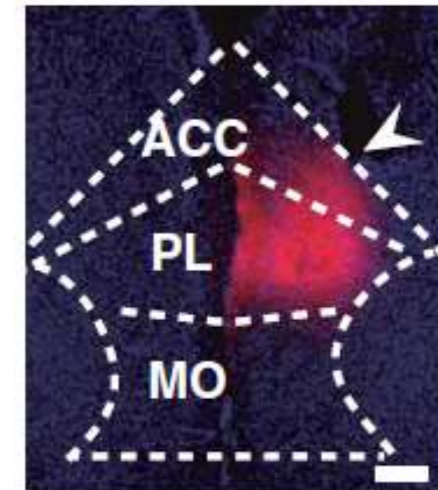

**Inhibiting cells in mPFC
reduces rank**

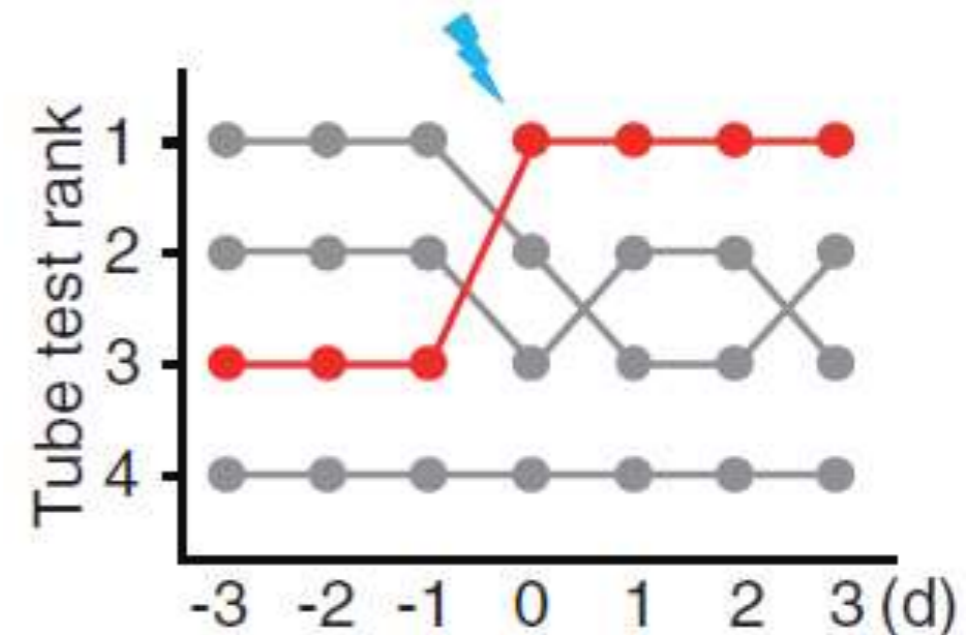

**Activating cells in mPFC
increases rank**

Questions

Social identity and memory – Hippocampus

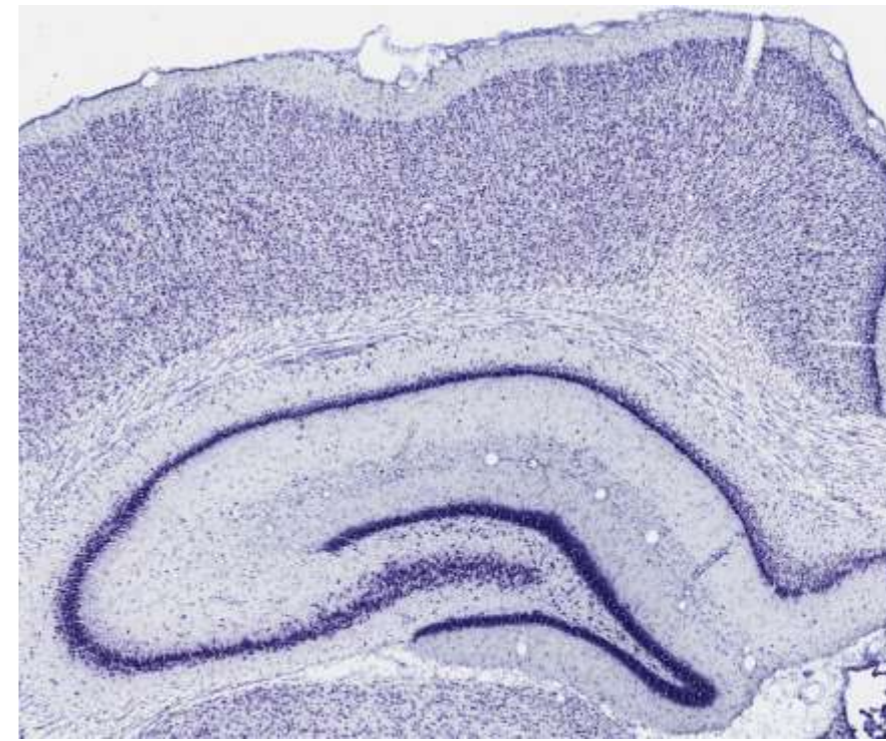
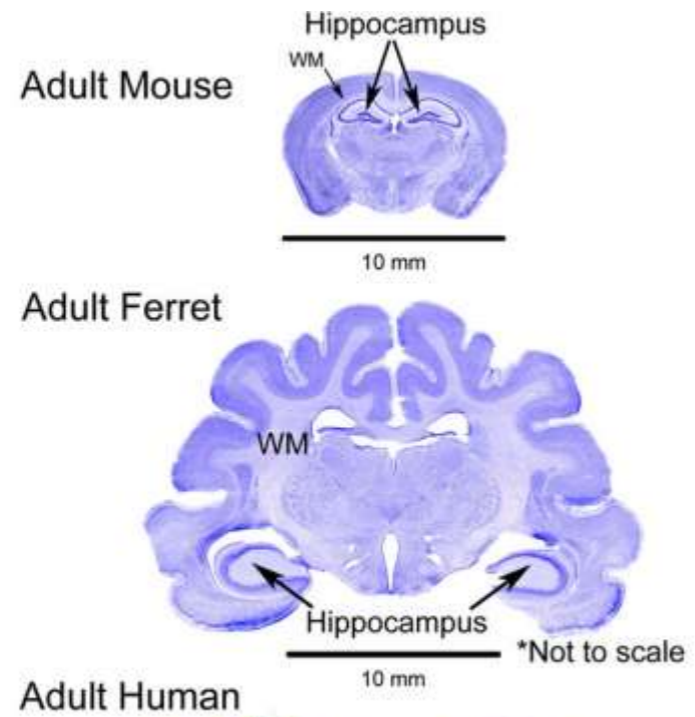

Mouse

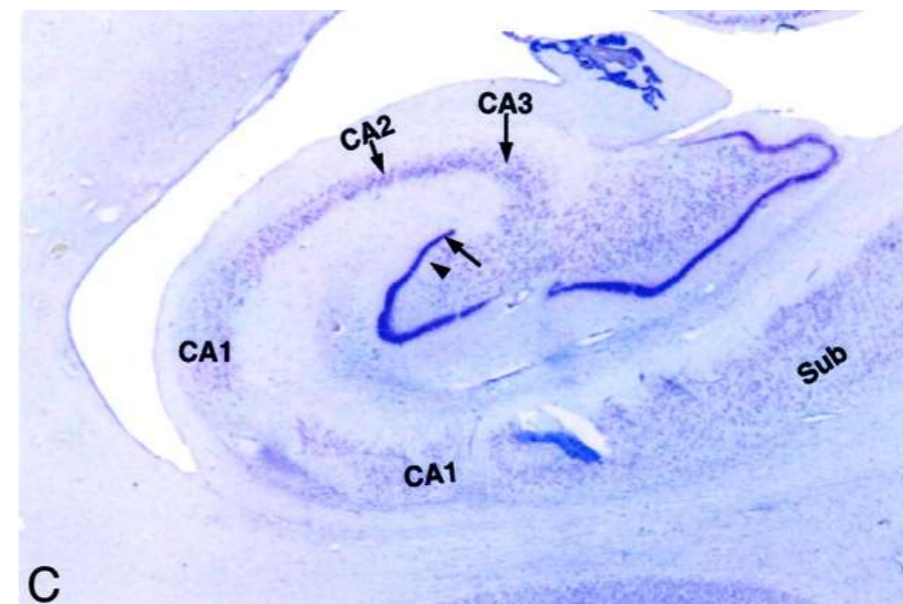

Human

Social Identity – Hippocampal representations of social identity

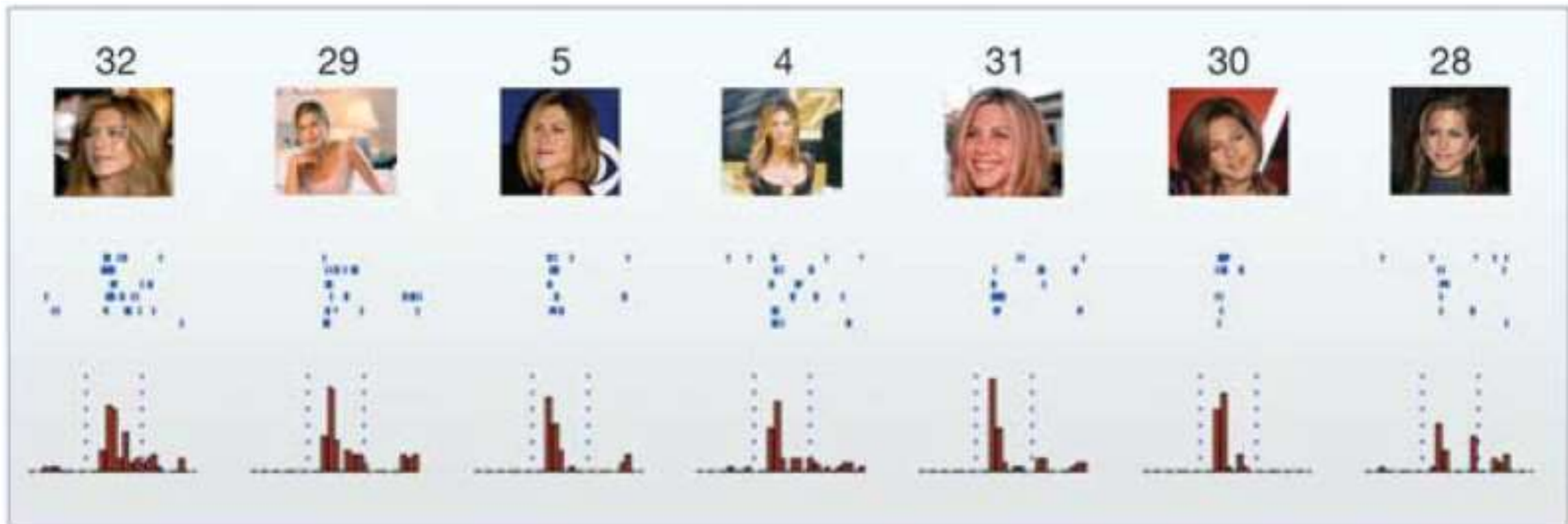
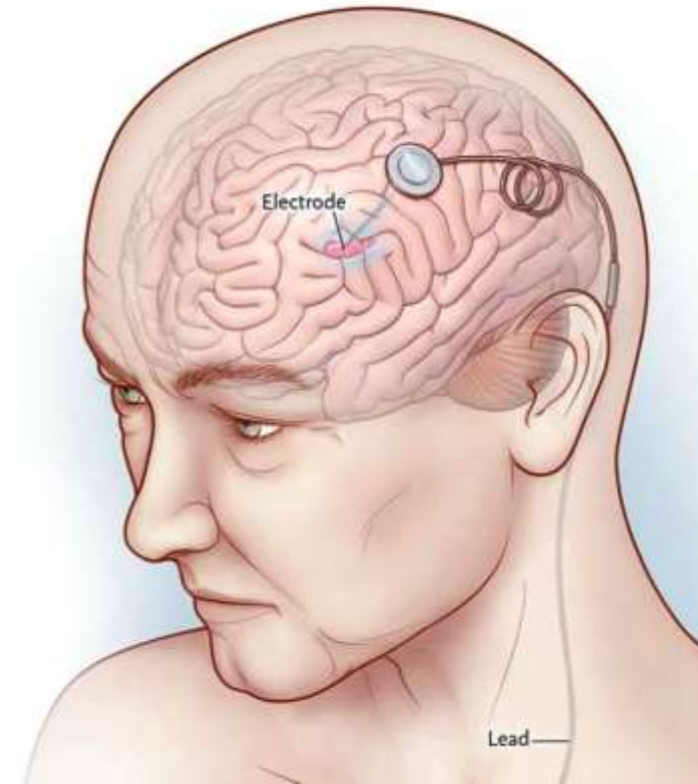
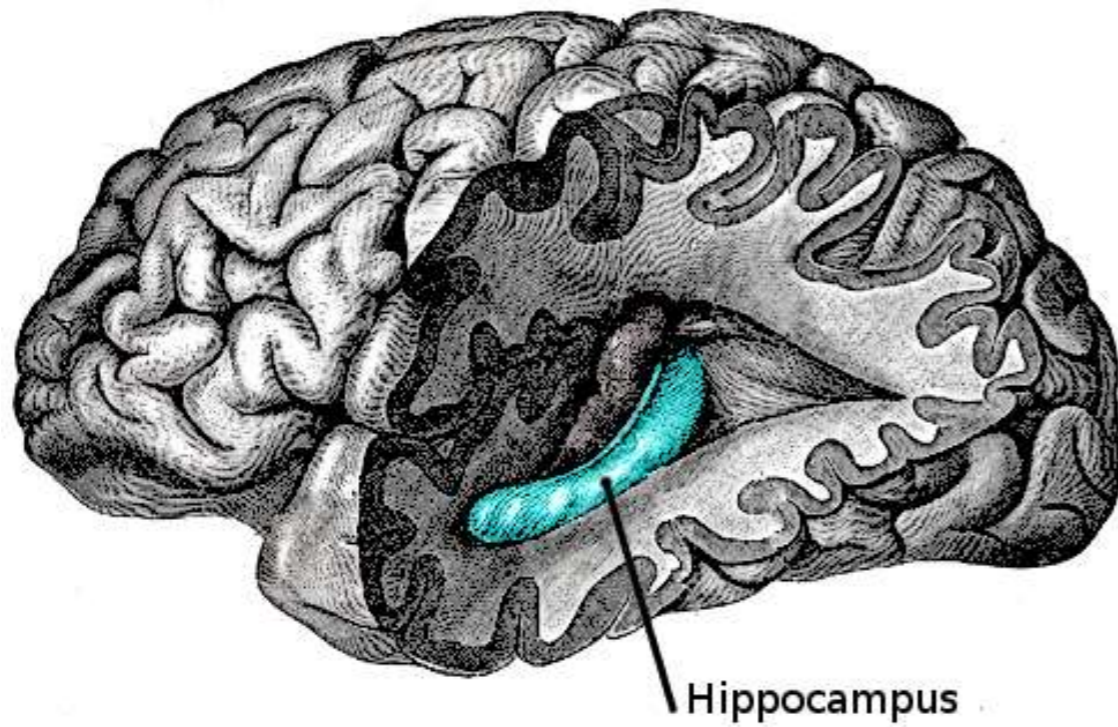

Social Identity – Jennifer Aniston Cell

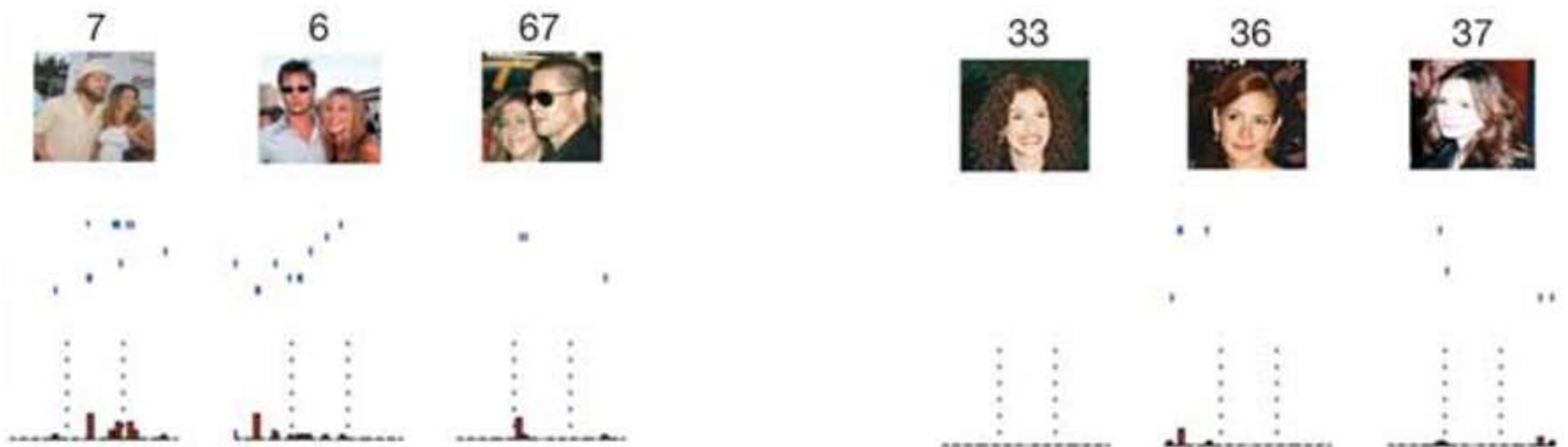
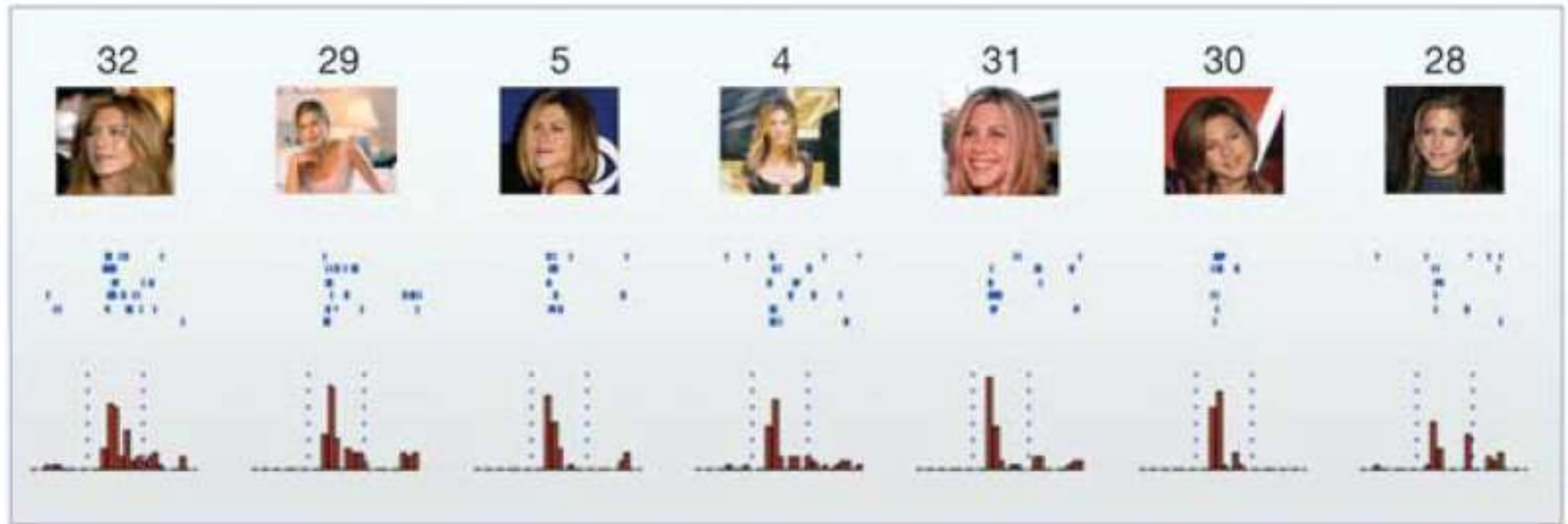

Social Identity – Halley Berry Cell

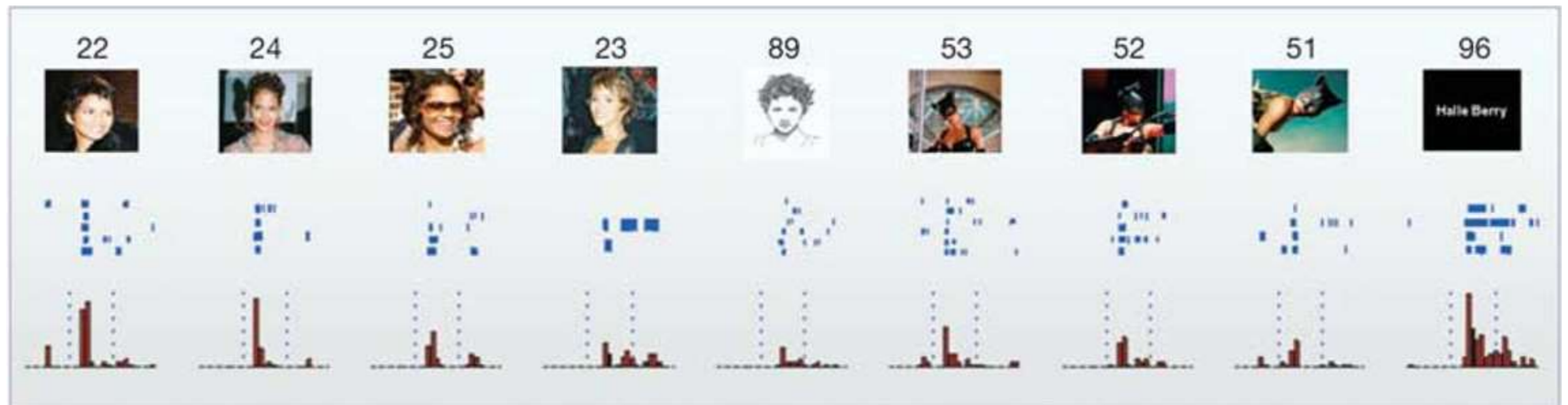

Also responded to the written name

Social Memory – CA2 region of hippocampus

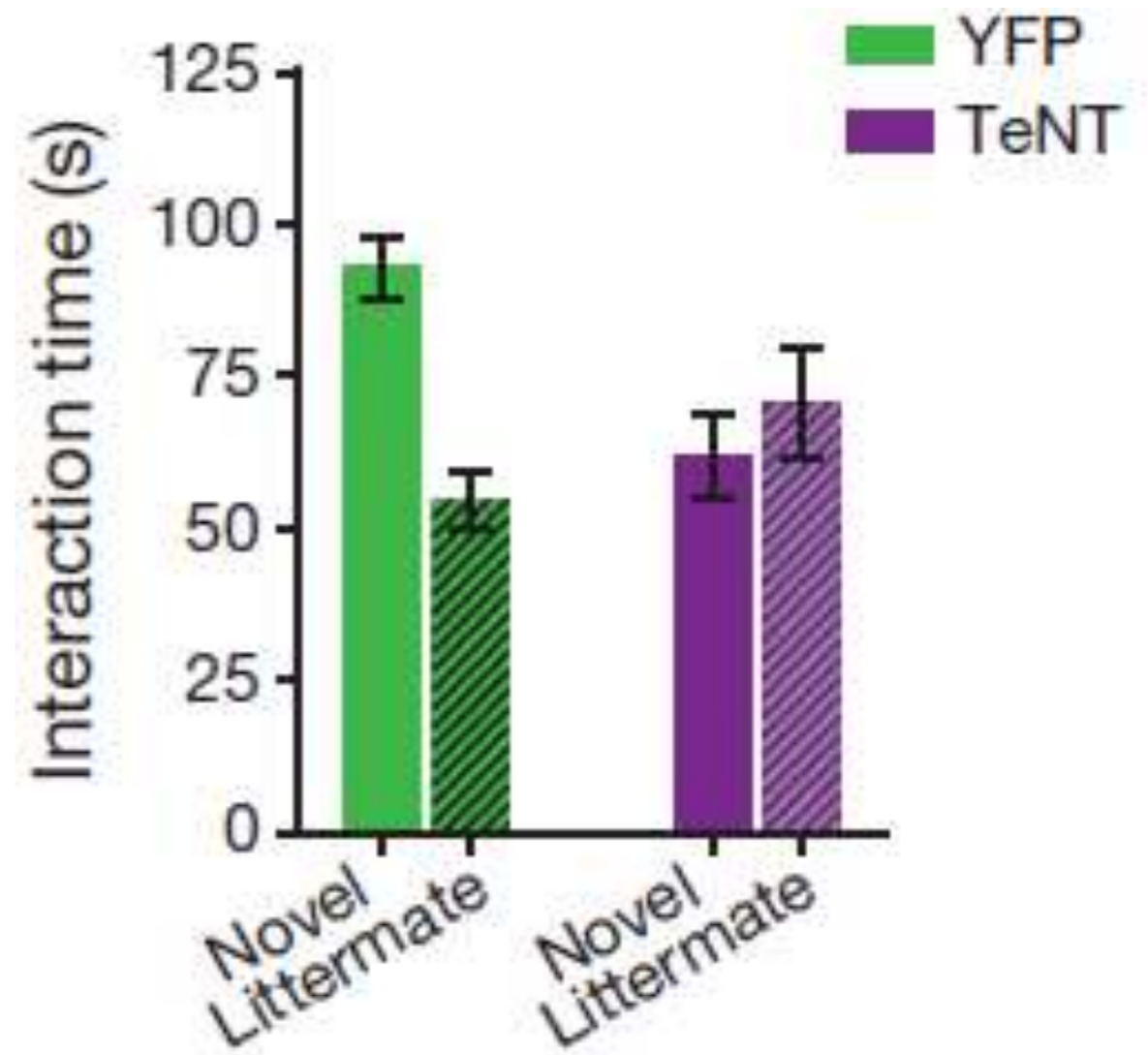
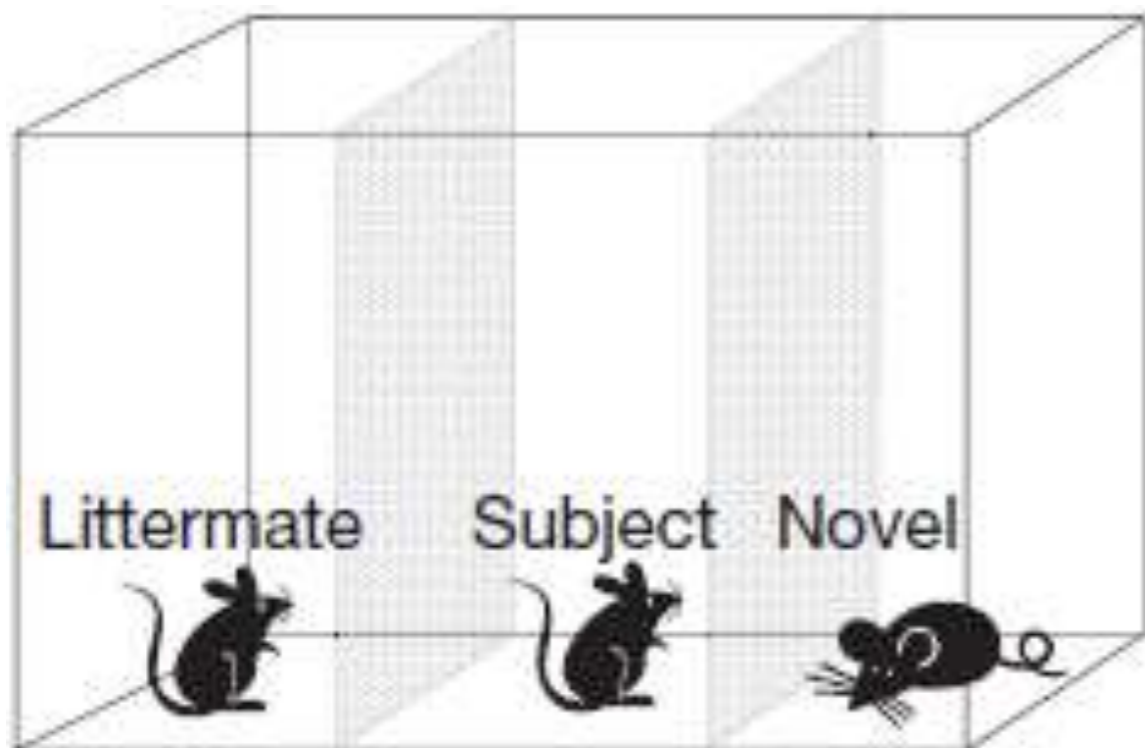
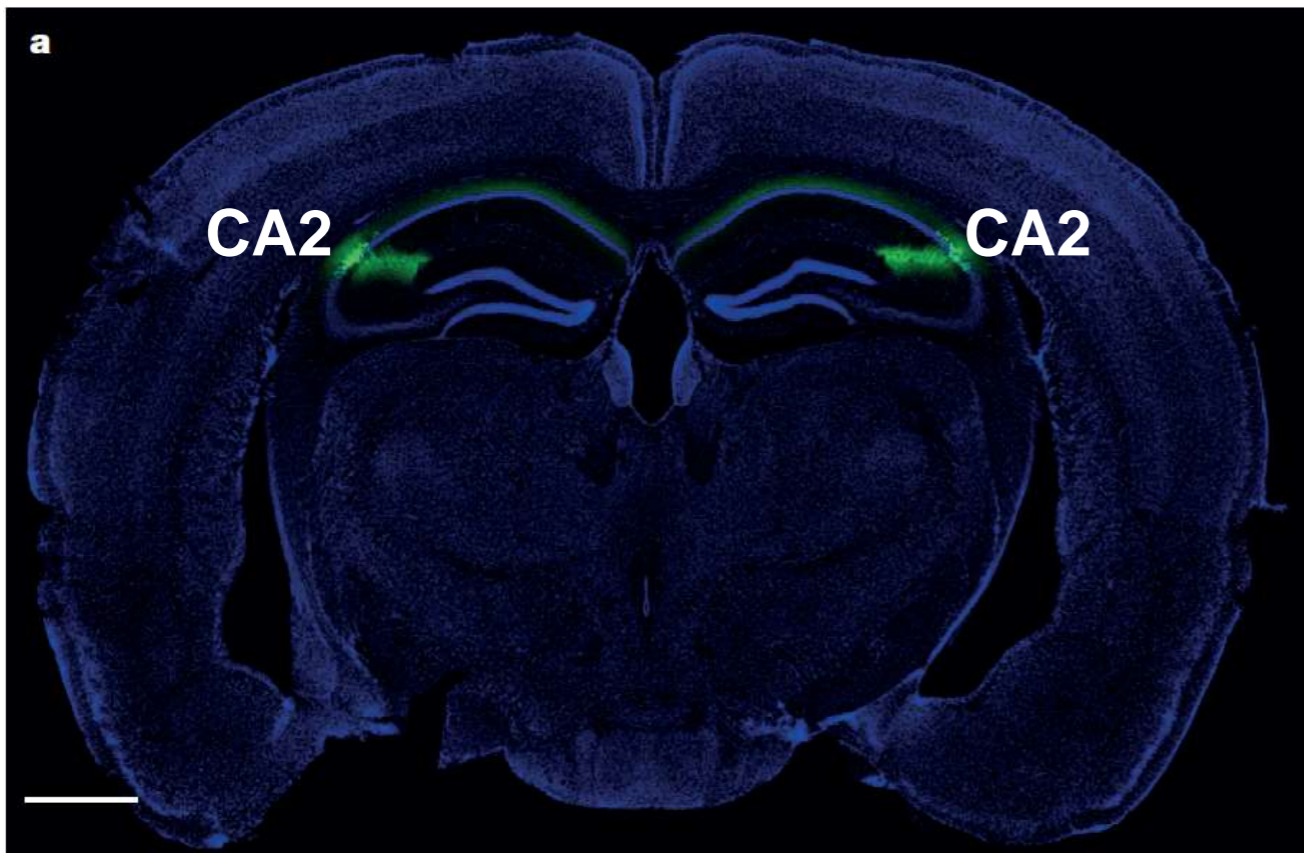

Social Memory – vCA1 region of hippocampus

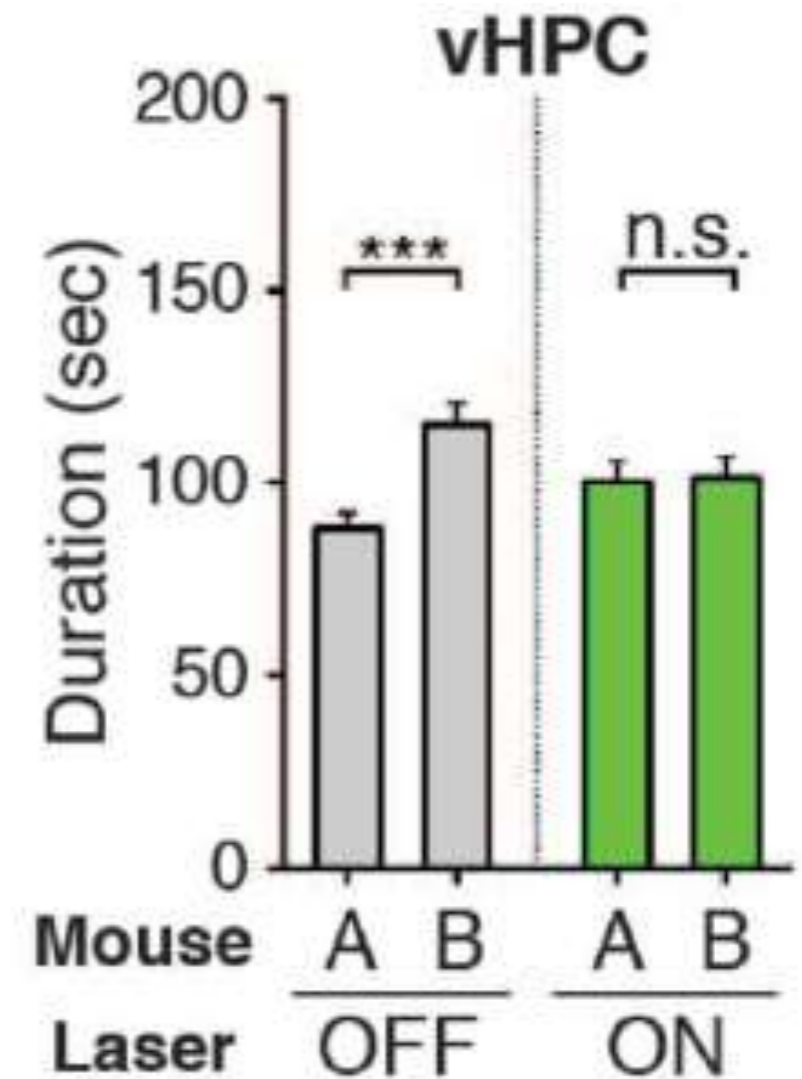
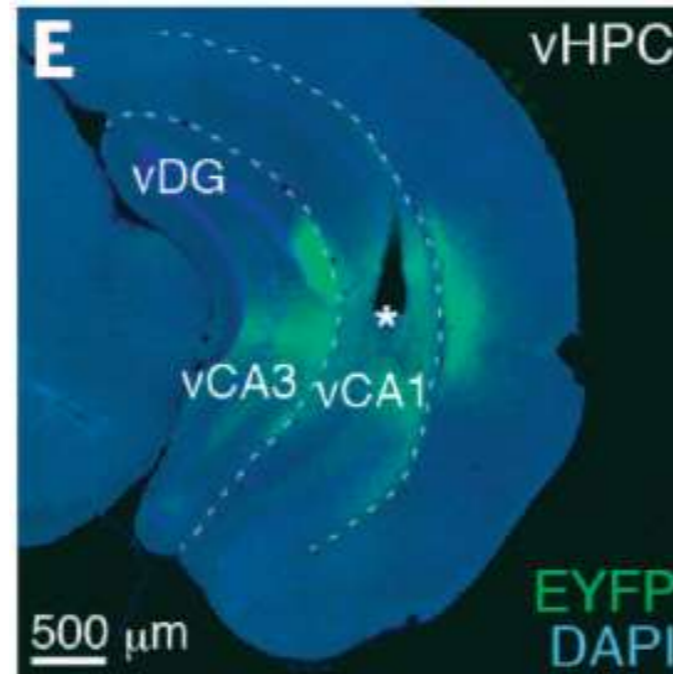
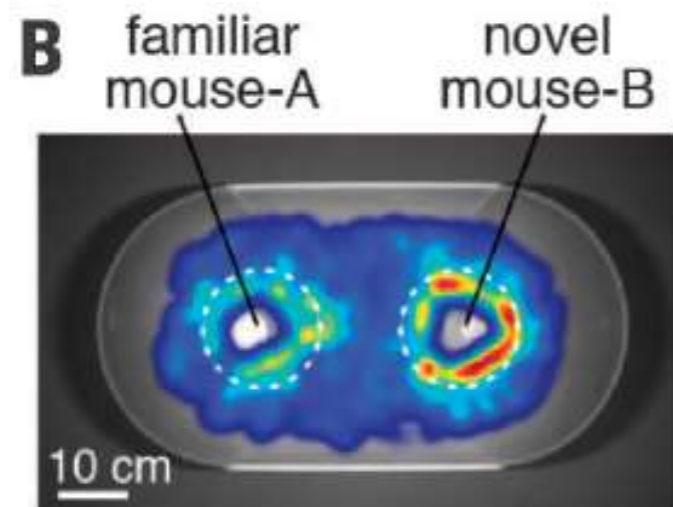
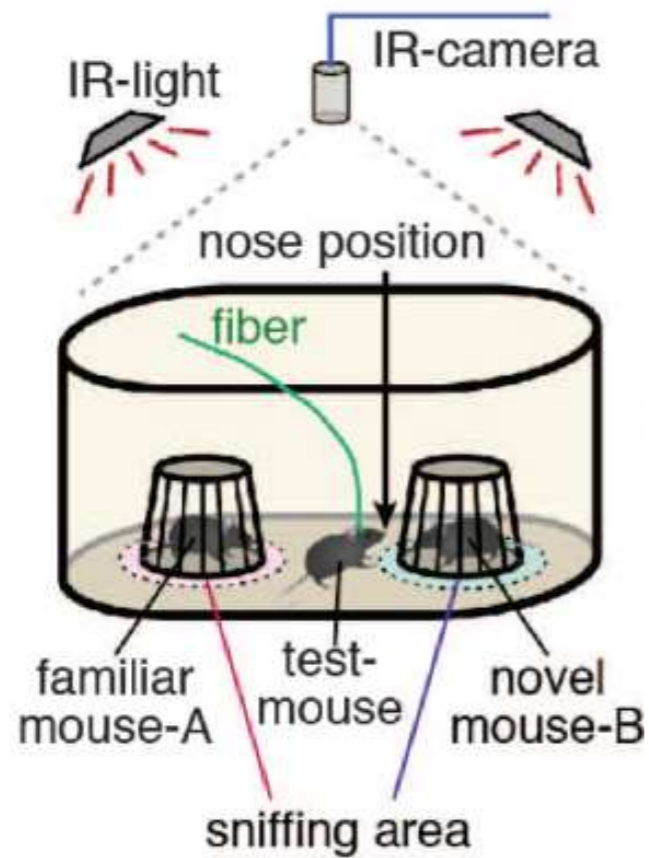

Social Memory – vCA1 region of hippocampus

Microendoscope

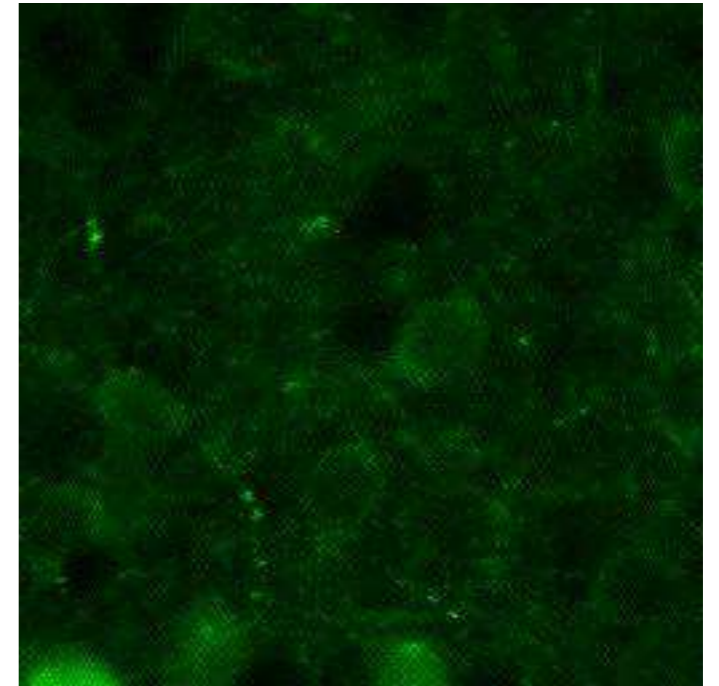
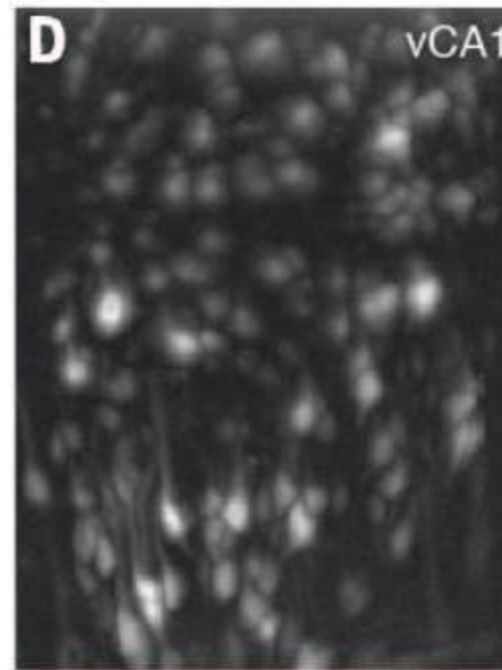
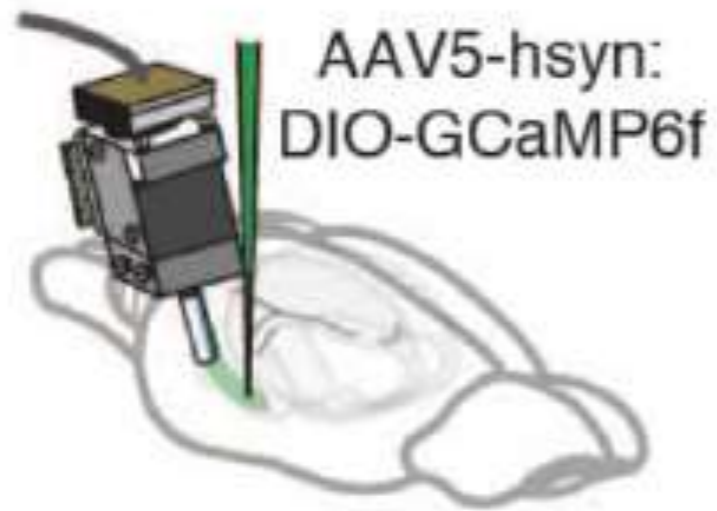

5x speed

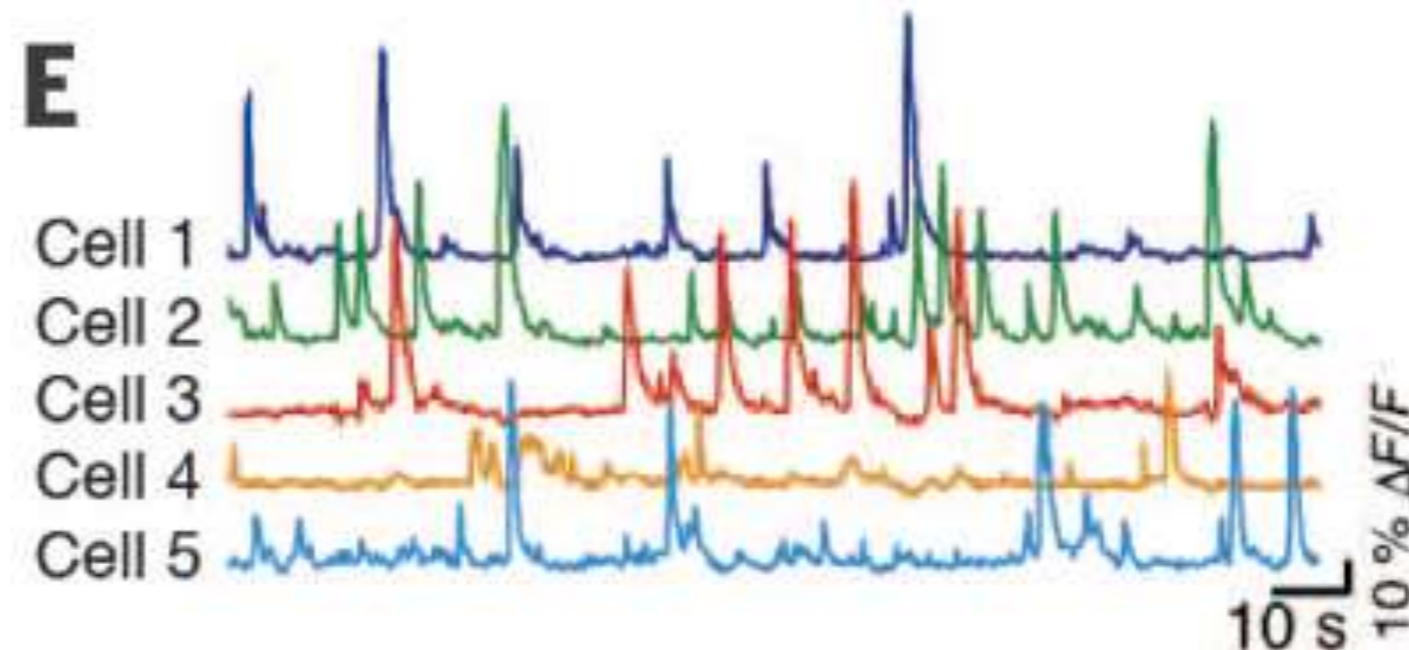

Tonegawa and colleagues

Social Memory – Number of neurons representing familiar mouse increases in vCA1

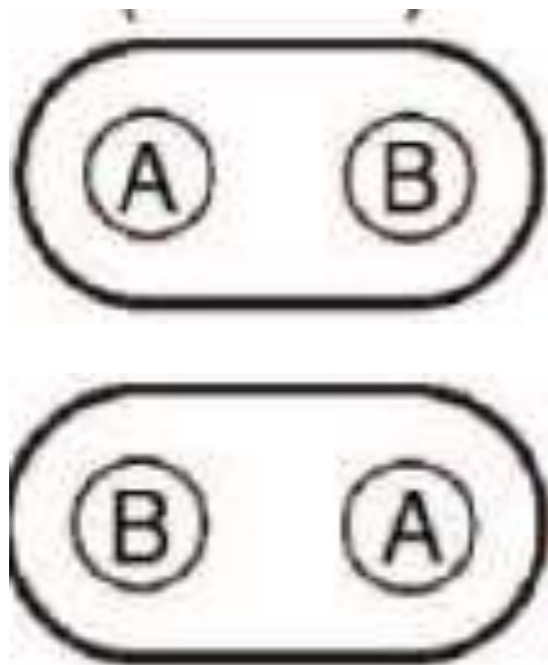
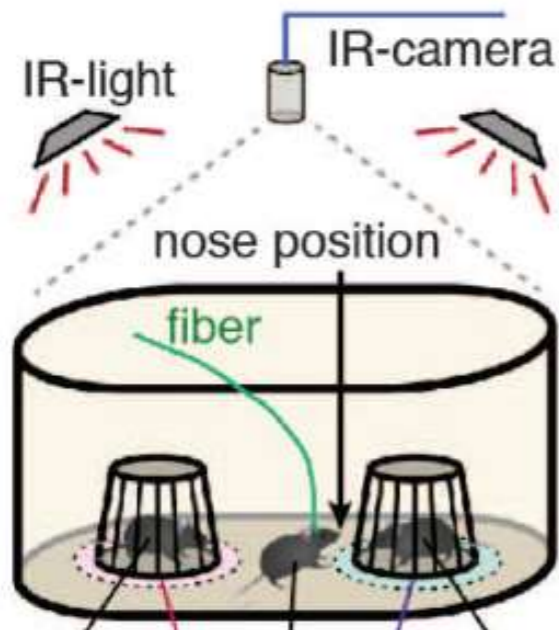

Then they familiarize with mouse A for 2 hours or 3 days

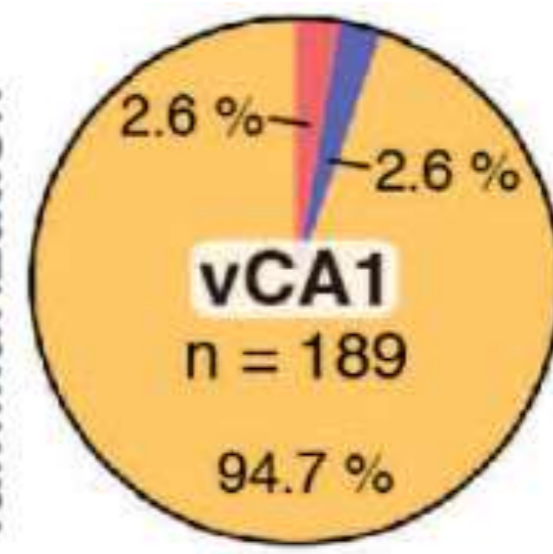
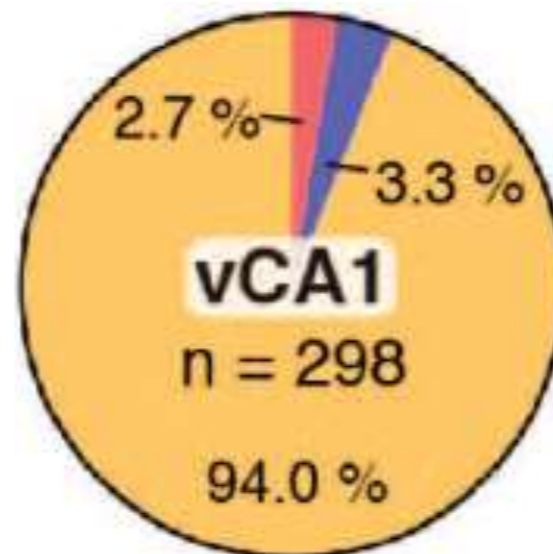

Before familiarization

↓ 2 h

↓ 3 days

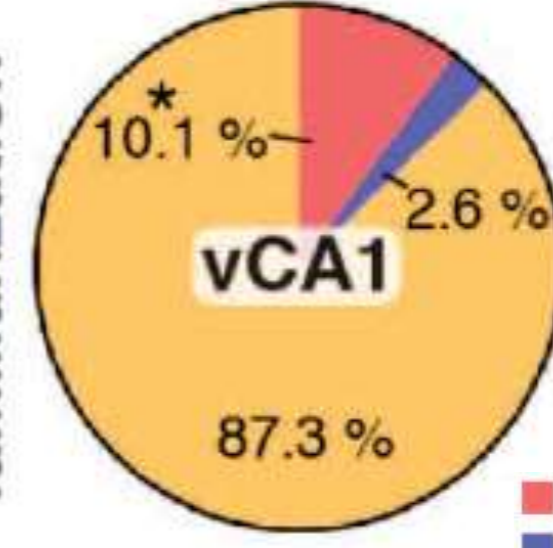
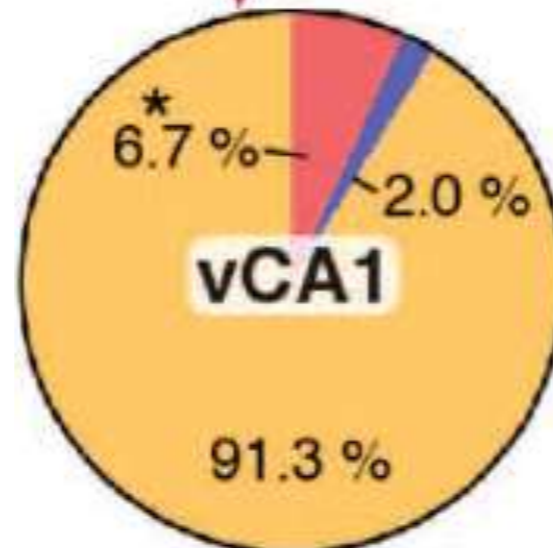

After familiarization

■ Mouse-A neuron
■ Mouse-B neuron
■ Neither

Social representation – Medial Amygdala

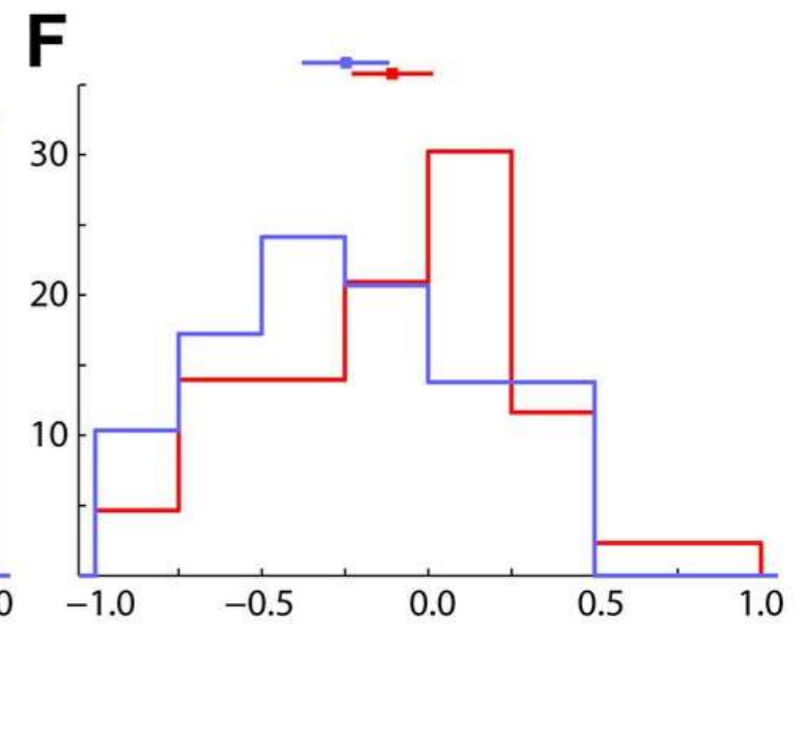
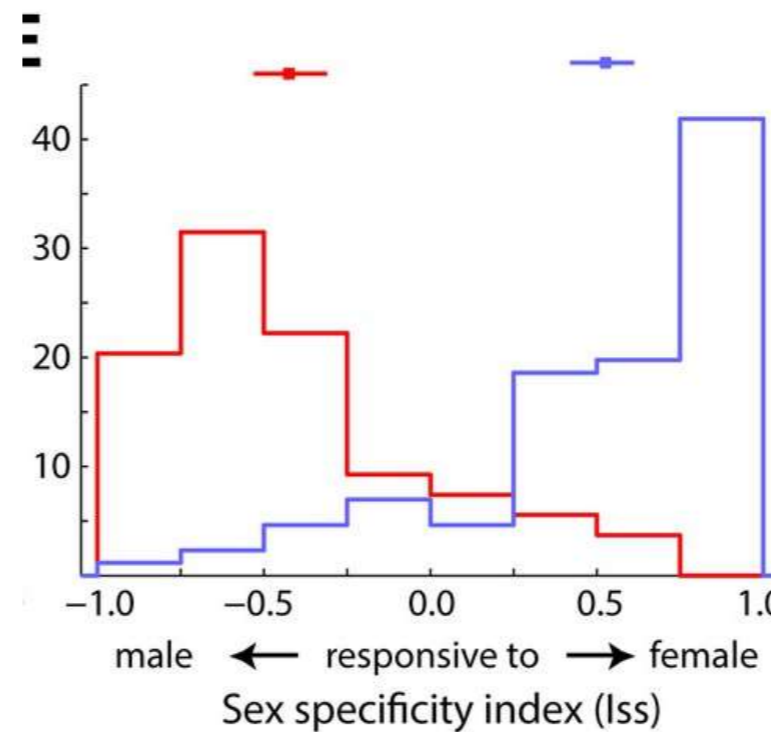
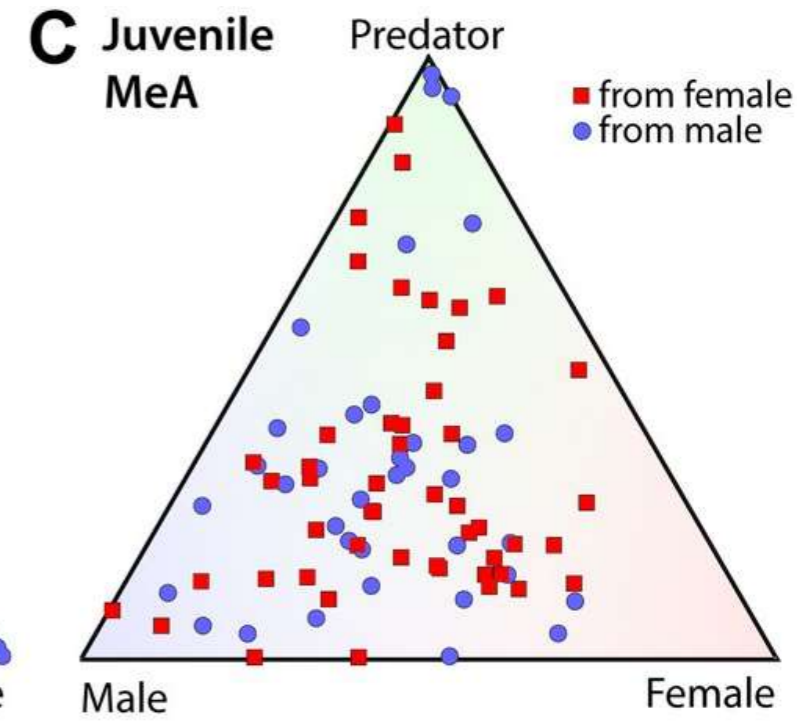
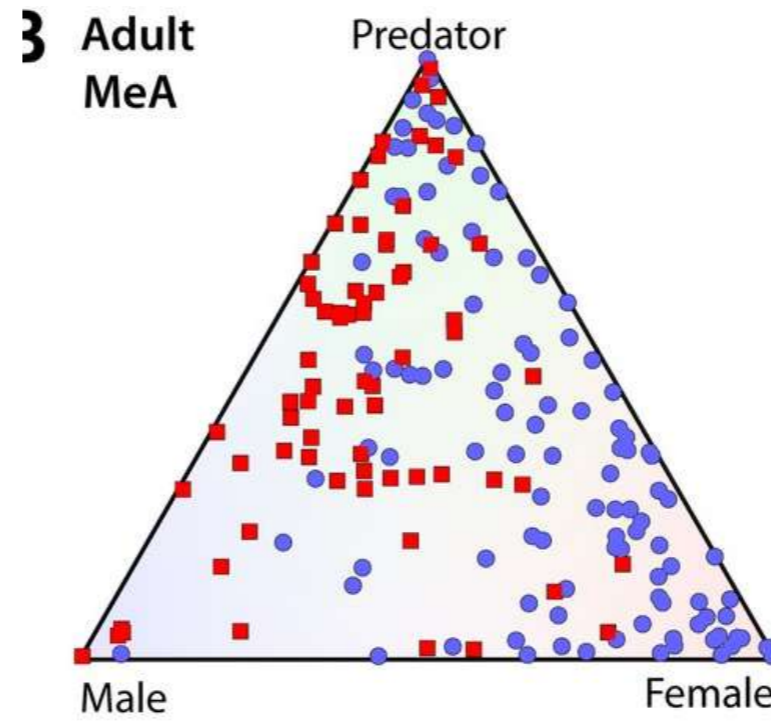
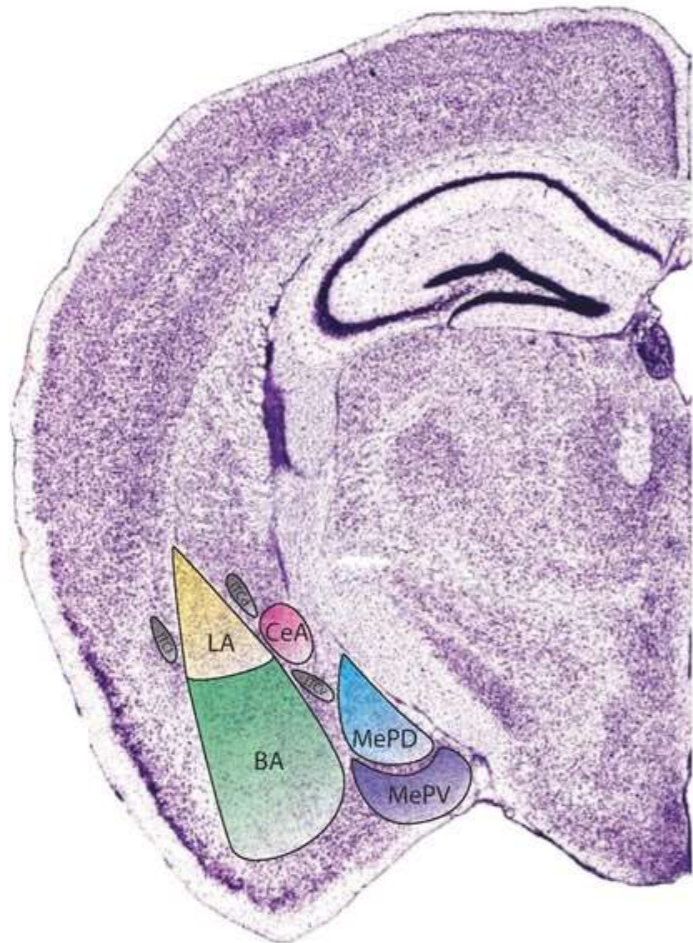

Hippocampus – Spatial Representation

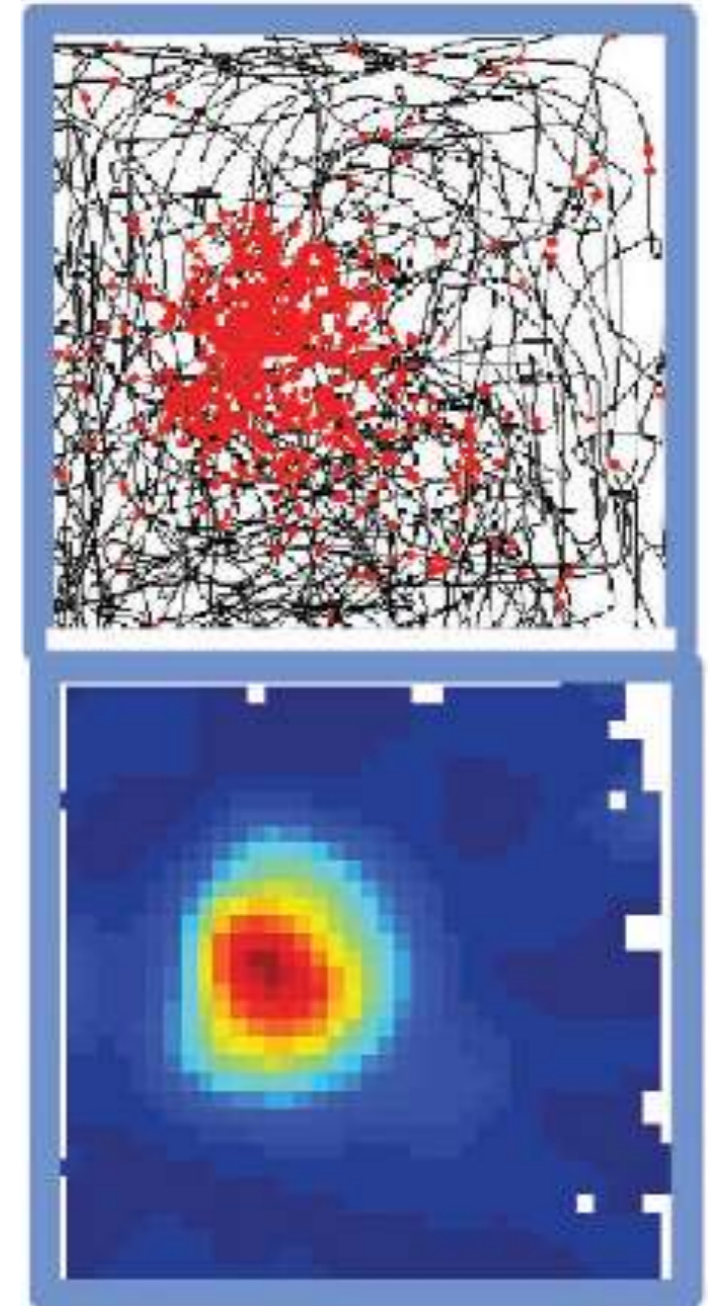
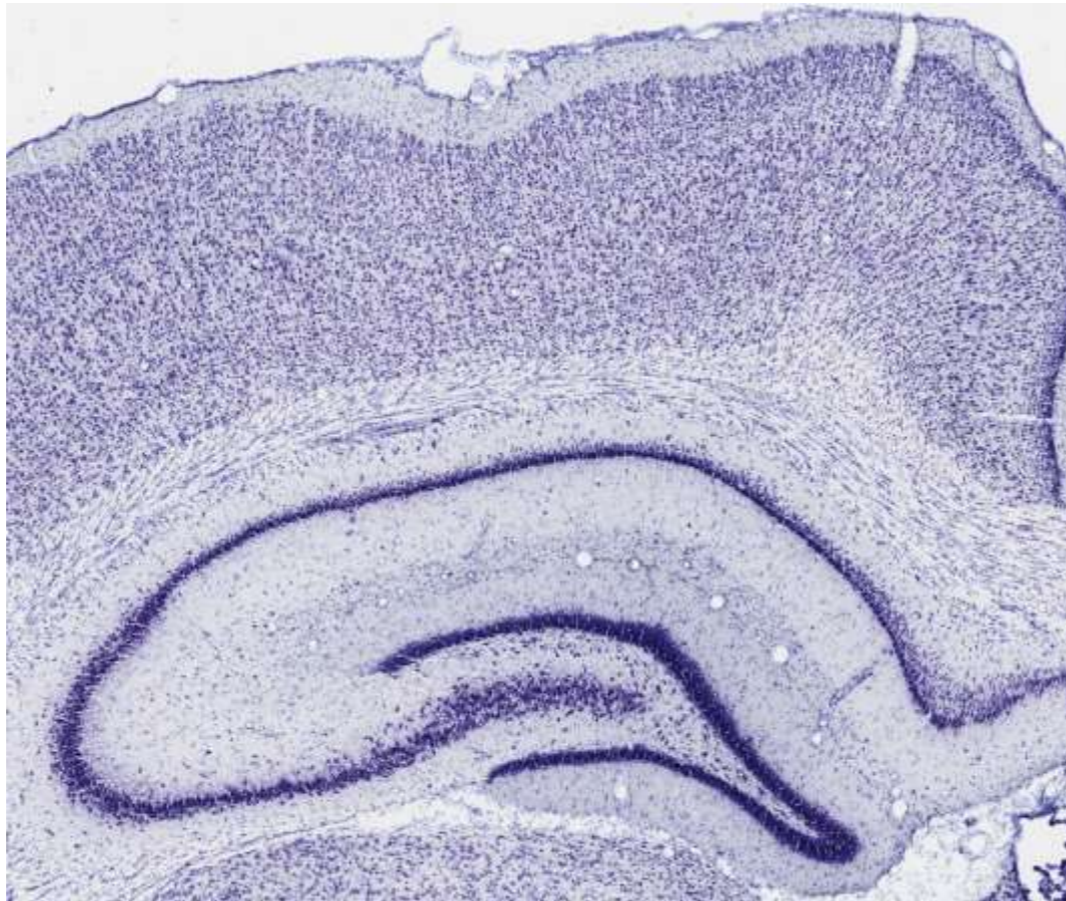

John O'Keefe

Social-Spatial Representation – dCA1 region of hippocampus

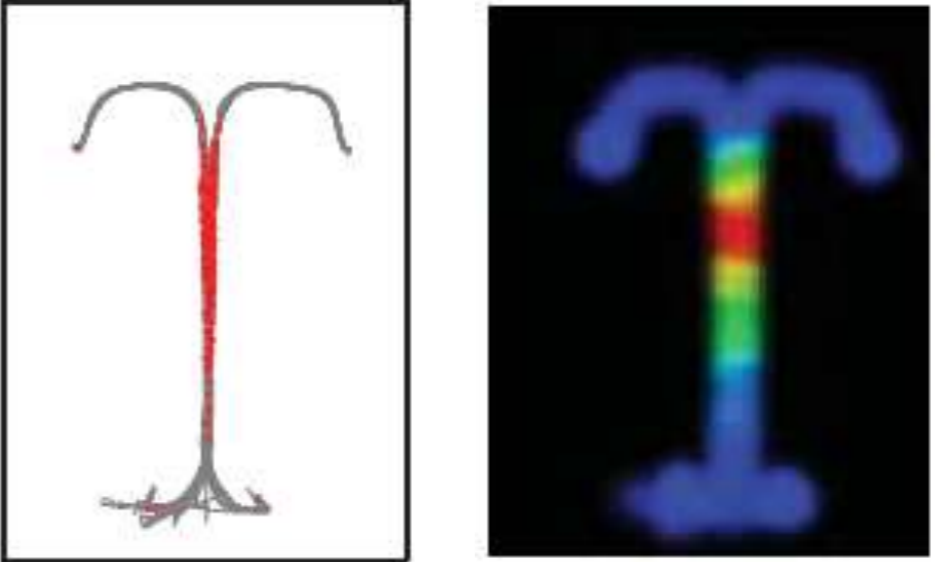
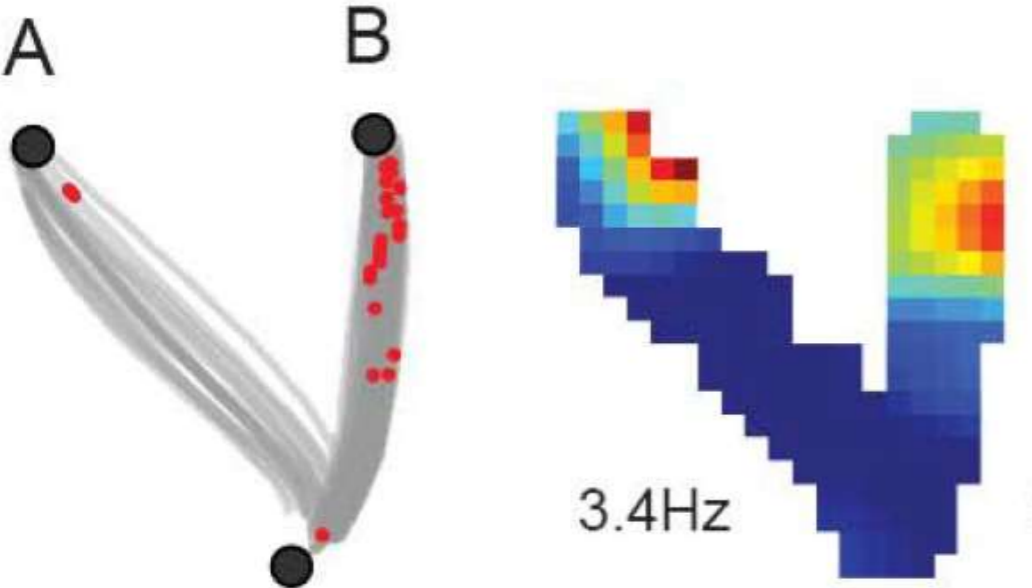
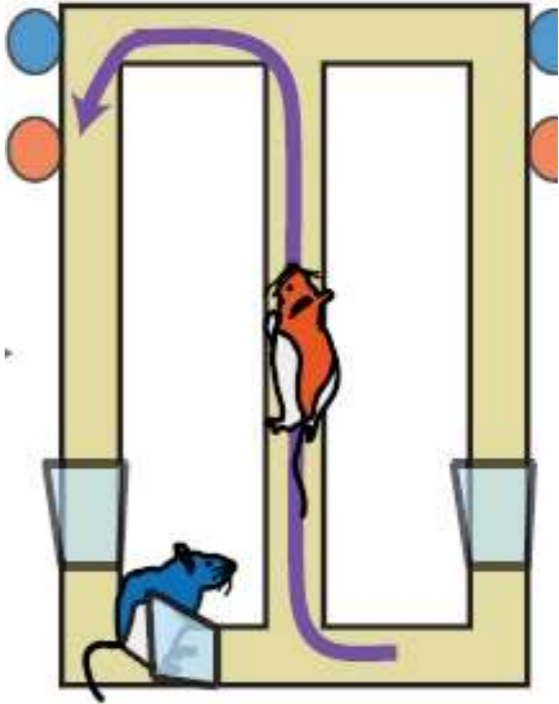
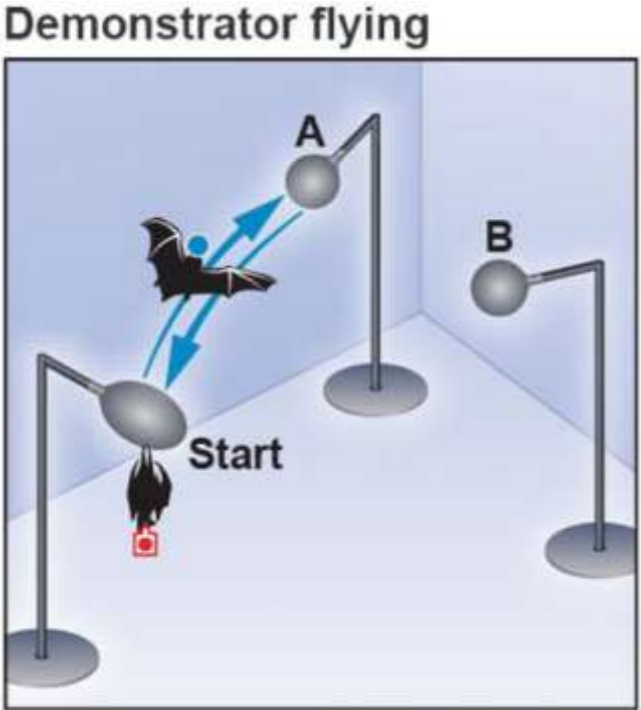

Ulanovsky and colleagues

Fujisawa and colleagues

Social-Spatial Representation – PL region of mPFC

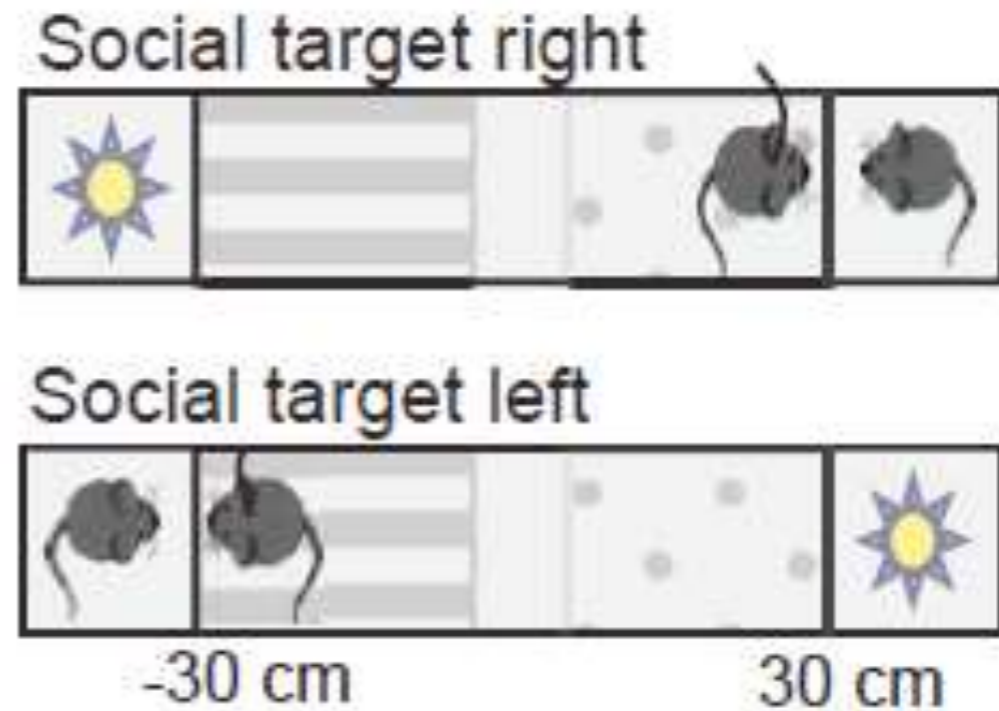
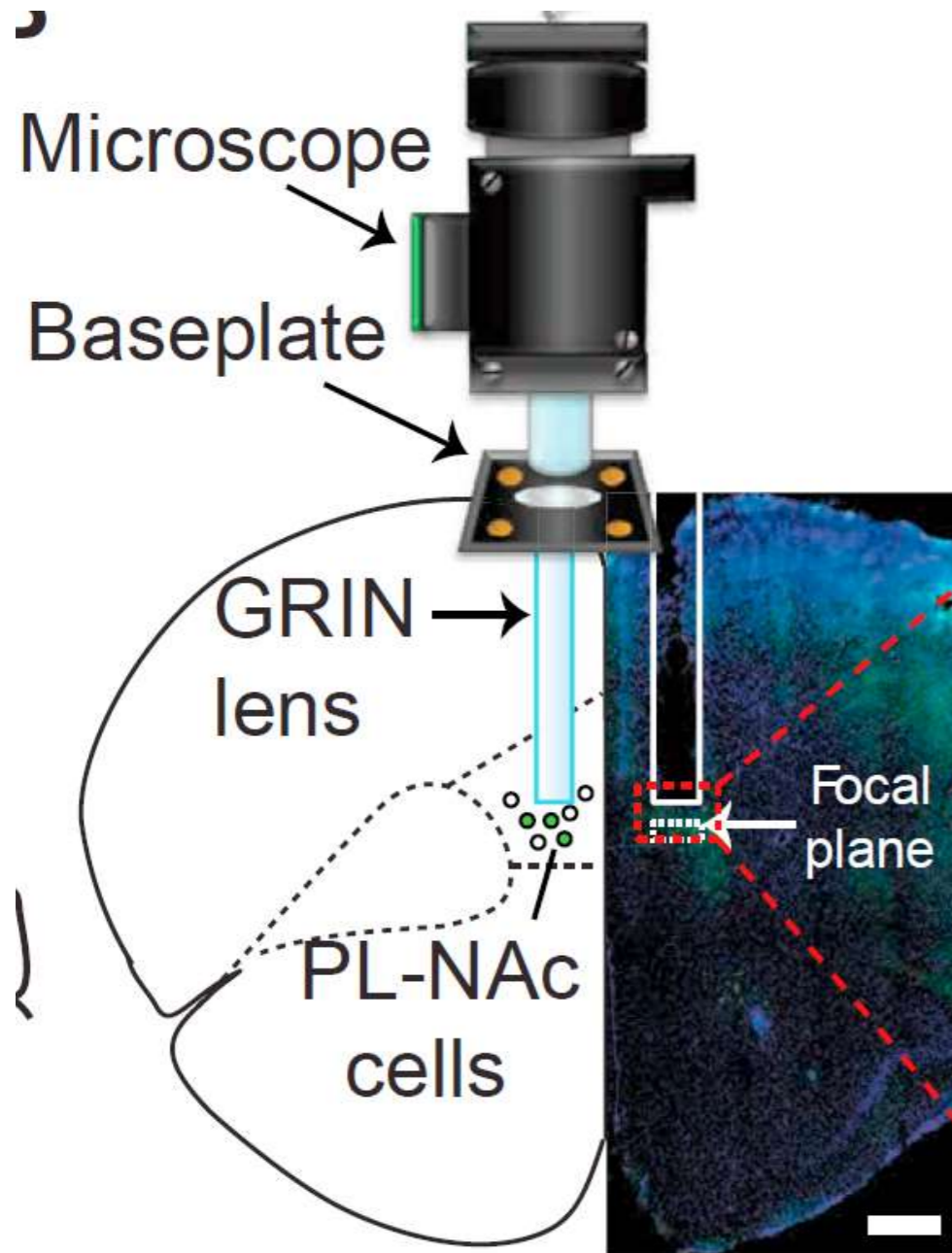

Social-Spatial Representation – PL region of mPFC

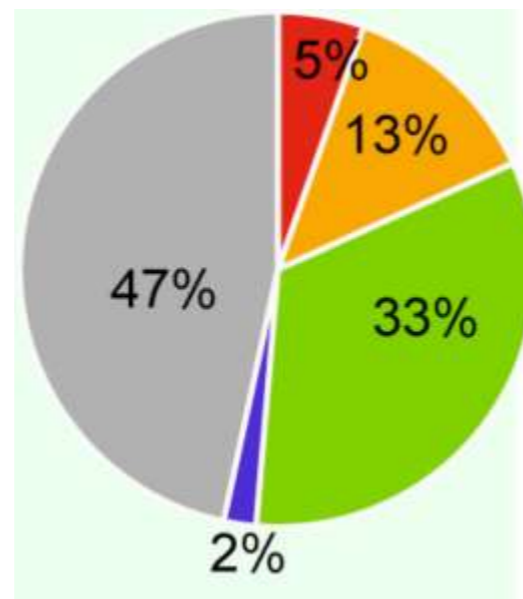
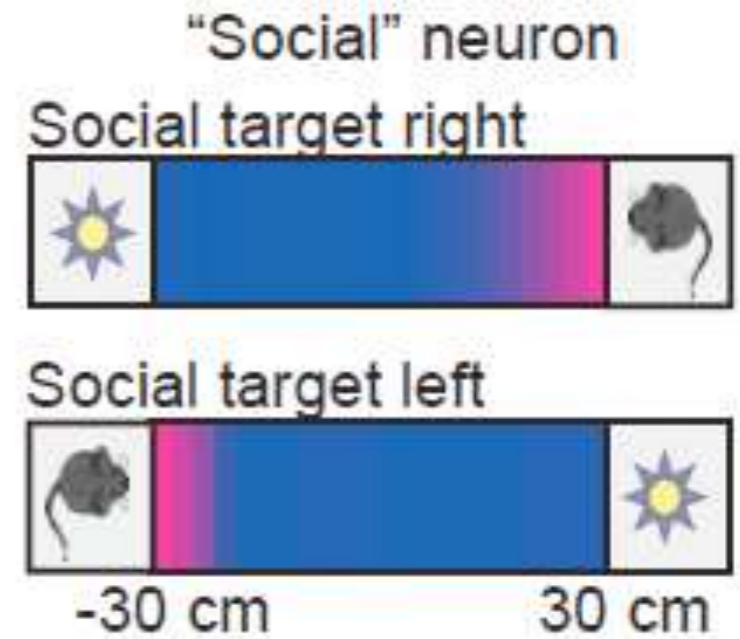
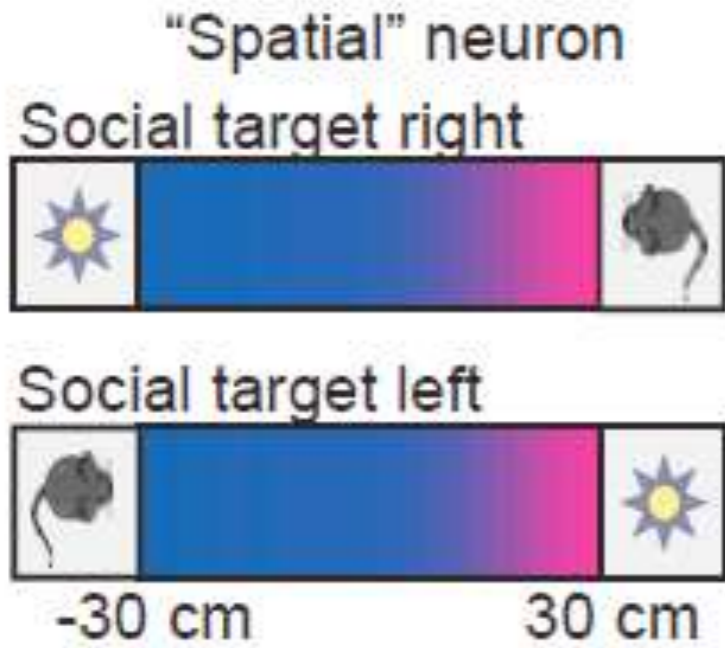

Social neurons
Spatial neurons
Social+Spatial neurons
Object neurons
Other significant neurons

Social representation and behavior in the brain

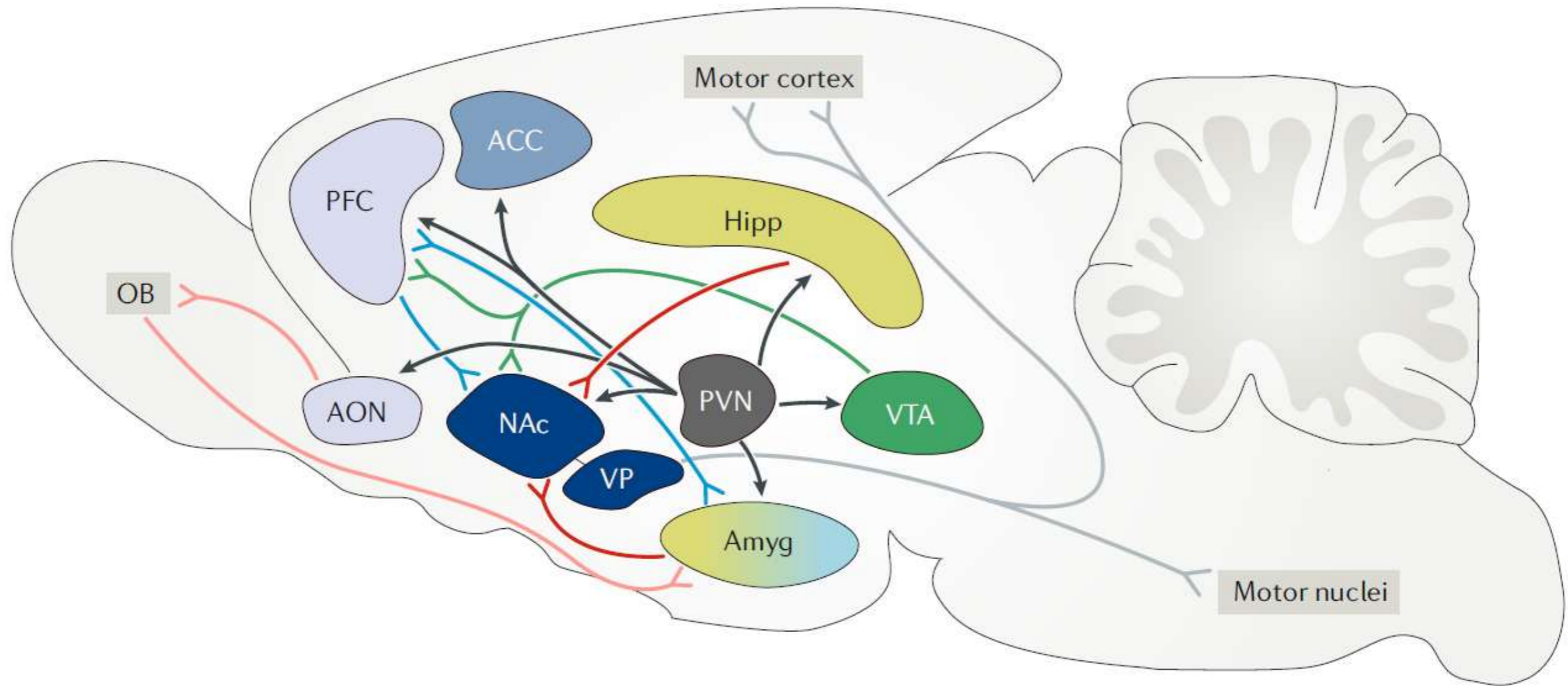

- | | |
|----------------------------|--------------------------|
| ● — OT and social salience | ● Valence |
| ● — Dopamine | ● Social memory (engram) |
| ● — Olfactory processing | ● Empathy |
| ● — Oscillatory modulation | ● Cortical control |
| ● — Social identity | ● Reward |
| ● — Motor output | |

Neuroscience of social behaviors – What are we not looking at

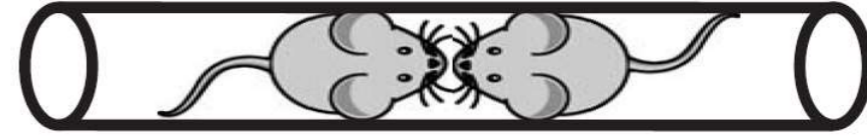

Neuroscience of social behaviors – What are we not looking at

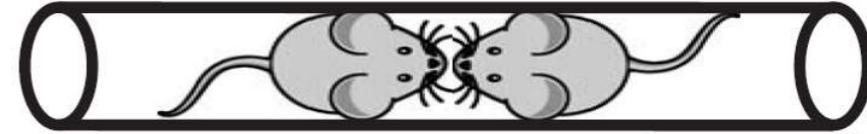

<https://www.youtube.com/watch?v=bzfqPQm-ThU>

Neuroscience of social behaviors – What are we not looking at



Group behaviors like hunting

...or communal defense



Neuroscience of social behaviors – What are we not looking at



Prosocial behaviors

Altruism



Neuroscience of social behaviors – Where they happen

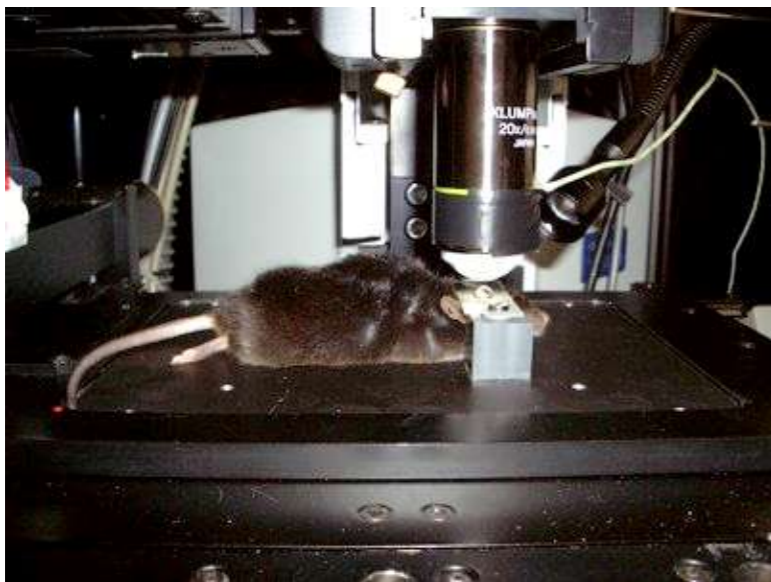
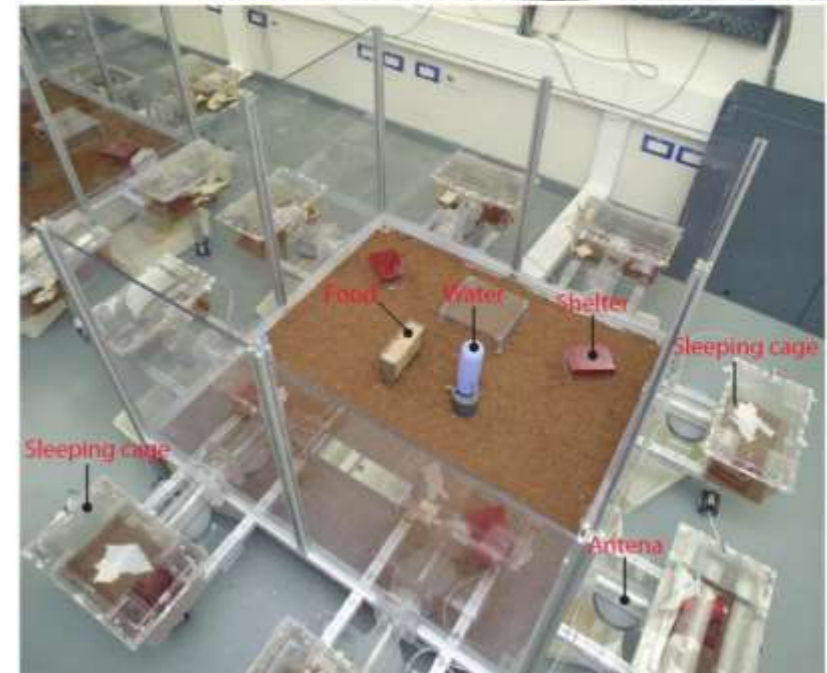
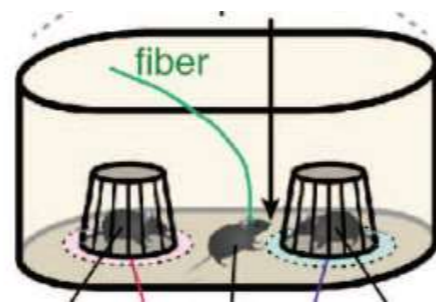

Neuroscience of animal behaviors – understanding umwelt

How we might perceive a village



How a fly might perceive a village



Understanding how the brain represents and executes behavior by

...“speaking to an animal in its own language” (studying behaviors relevant to it)

...“and in its own world.” (studying them in surroundings in which the animal evolved to express those behaviors – natural or naturalistic)

Summary

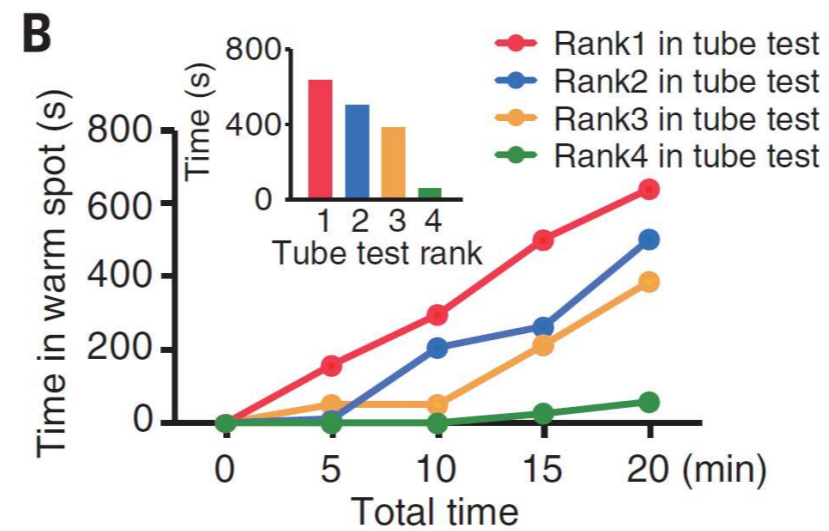
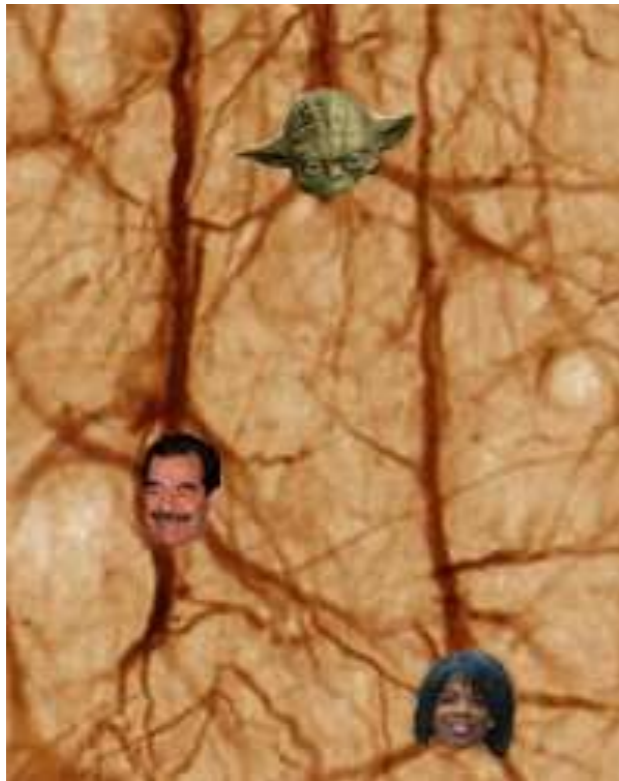

Questions