

# VI K-SPACE

Lecture notes by Assaf Tal

## 1. INTRODUCING K-SPACE

### 1.1 INTRODUCING K-SPACE

In thermal equilibrium, the spins in the human body all point along the main  $B_0$ -field.

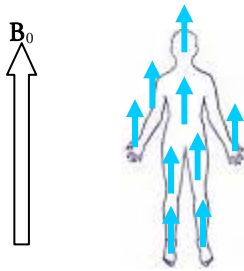

In general, the equilibrium magnetization  $M_0$  is proportional to the number of water molecules per unit volume, which varies from tissue to tissue. Hence, in thermal equilibrium:

$$\mathbf{M}(\mathbf{r}) = M_0(\mathbf{r}) \hat{\mathbf{z}}$$

i.e., the magnetization points along the z-direction and its magnitude,  $M_0$ , is a function of the spatial coordinate  $\mathbf{r}=(x,y,z)$ .

What happens to  $\mathbf{M}(\mathbf{r})$  when we excite the spins with a  $\pi/2$  hard pulse? They get tilted onto the xy-plane:

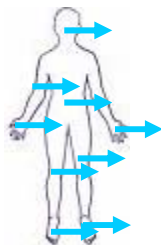

Consider the following experiment:

1. The spins are excited w/ a hard  $\pi/2$  pulse.
2. A constant gradient  $\mathbf{G}=(G_x,G_y,G_z)$  is turned on, while simultaneously acquiring.

The signal we acquire will originate from all spins in the sample: it will simply be the sums of the signals from the individual spins. Remember that a single spin, precessing in the xy-plane with an angular velocity  $\omega$  (given by its offset), gives rise to a signal proportional to

$$s(t) \propto M_0 e^{-i\omega t}$$

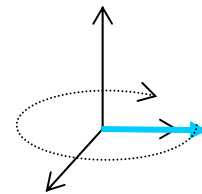

In general, in our body, the density of water (which is basically proportional to the density of spins we observe) is not constant, so the thermal equilibrium bulk magnetization,  $M_0$ , varies as a function of position  $M_0(\mathbf{r})$ . Hence, each position in the body,  $\mathbf{r}$ , will give rise to a signal proportional to

$$s(\mathbf{r},t) \propto M_0(\mathbf{r}) e^{-i\omega(\mathbf{r})t}.$$

The total signal from all spins in the body is given by summing over the entire body/object being imaged:

$$\begin{aligned} s(t) &= \int_{\text{object}} s(\mathbf{r},t) d\mathbf{r} \\ &= \int M_0(\mathbf{r}) e^{-i\omega(\mathbf{r})t} d\mathbf{r} \end{aligned}$$

Now, what is  $\Delta\omega(\mathbf{r})$  in the presence of a gradient?

$$\begin{aligned} \omega(\mathbf{r}) &= \gamma \mathbf{G} \cdot \mathbf{r} \\ &= \gamma G_x x + \gamma G_y y + \gamma G_z z \end{aligned}$$

Here I've assumed the water has no chemical shift, so  $\Delta\omega = 0$  when the gradient is turned off. Now, I'm going to define

$$\mathbf{k}(t) = \gamma \mathbf{G}t$$

such that

$$s(t) = \int M_0(\mathbf{r}) e^{-i\gamma \mathbf{G} \cdot \mathbf{r}t} d\mathbf{r}$$

$$= \int M_0(\mathbf{r}) e^{-i\mathbf{k}(t) \cdot \mathbf{r}} d\mathbf{r}$$

Looking at this expression, with our definition of  $\mathbf{k}$ , we see that the signal is somehow the (3D) Fourier transform of the spin density  $M_0(\mathbf{r})$ , which is precisely the image we're after. In fact, we can think up a very crude imaging experiment right now; let's confine ourselves to 2D (rather than 3D) imaging just to make things slightly simpler:

1. Select a 2D grid (for 2D imaging), e.g.

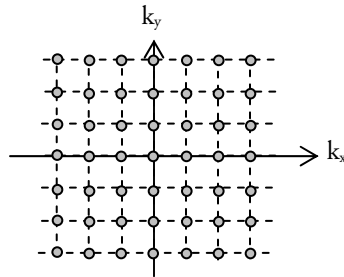

2. Excite the spins.
3. Select a value of  $\mathbf{k}_0 = (k_x, k_y)$  from the grid (one of the grey dots). For example, suppose we've picked the dot I've colored using red,  $\mathbf{k}_0 = (k_{x0}, 0)$ , also denoted using an arrow, for those of you without color printers:

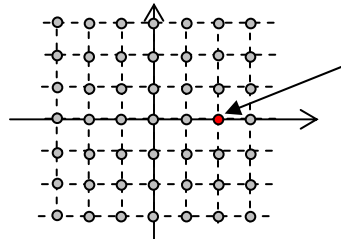

4. Apply the appropriate gradients  $\mathbf{G} = (G_x, G_y)$  for enough time until  $\mathbf{k}(t) = \gamma \mathbf{G}t$  matches the chosen value,  $\mathbf{k}_0$ . In the above example, we'd set  $G_y = 0$ ,  $G_x = \text{some value } G_{x0}$ , and then  $t = k_{x0} / \gamma G_{x0}$ .
5. Record the value of the signal at that point.
6. Wait until the spins return to thermal equilibrium.
7. Repeat steps 2-6 enough times until all values of  $\mathbf{k}$  on our grid are collected. When this is achieved, apply the inverse FT to the data to recover the image.

That's a very inefficient yet fundamentally correct way of getting an image. It's extremely inefficient because you need a different experiment for each  $\mathbf{k}$ -value you record. In reality, that's not how it's done.

## 1.2 MORE ABOUT K-SPACE

Let us formalize the notions introduced in the previous section. For, we redefine  $\mathbf{k}(t)$  to be the area under the gradient:

$$\mathbf{k}(t) = \gamma \int_0^t \mathbf{G}(t') dt'$$

so  $k_x(t)$  is the area under the gradient  $G_x(t)$  up to time  $t$ ,  $k_y(t)$  is the area under  $G_y(t)$  up to time  $t$ , and  $k_z(t)$  is the area under  $G_z(t)$  up to time  $t$ . In general, we can apply gradients along all three axes simultaneously, if we'd prefer to.

Let's first see an example of how to calculate  $\mathbf{k}(t)$ . Suppose we were to apply the following gradients:

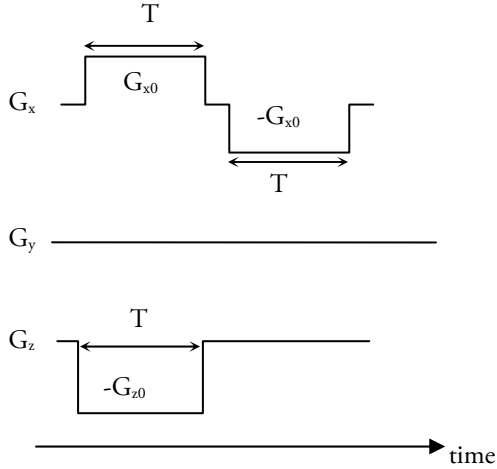

This would lead to the following  $\mathbf{k}$  (as a function of time):

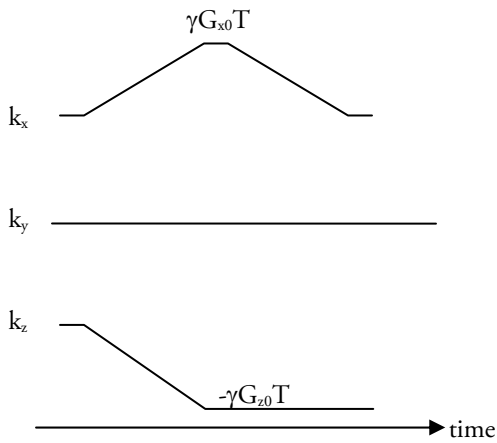

At each instant in time, we can think of  $\mathbf{k}(t)$  as a point in the  $(k_x, k_y, k_z)$  space, so by changing the gradient, we're actually "taking a walk" in  $\mathbf{k}$ -space. For the above example (I'll omit  $k_y$  because it is 0, and draw just the  $k_x$ - $k_z$  plane):

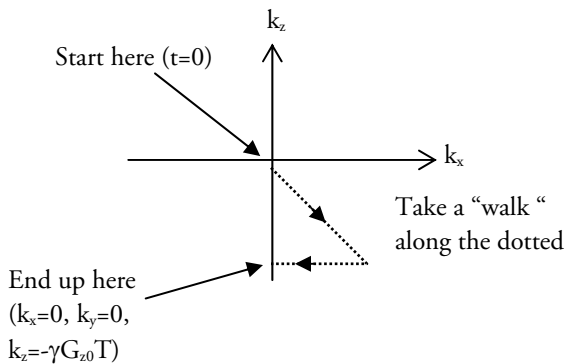

So far so good, but how does this relate to our signal? In the remainder of this section I'm going to prove to you that:

$$s(t) \propto \int M_0(\mathbf{r}) e^{-i\mathbf{k}(t) \cdot \mathbf{r}} d\mathbf{r}$$

We got this result before for a constant gradient; now I'm going to show to you it holds even when you vary the gradient as a function of time. If you don't feel like going through the proof, just skip ahead to section 3.3 that deals with the bottom line.

Let's look at a single spin. Suppose we've excited it from its thermal equilibrium position onto the x axis. Following the pulse,

$$\begin{cases} M_x = M_0 \\ M_y = 0 \\ M_z = 0 \end{cases}$$

Neglecting relaxation for now,  $M_z$  will remain 0 throughout acquisition, and the spin will merely precess in the  $xy$ -plane according to its offset  $\Delta\omega$ , whatever it may be. We'll switch to complex notation:

$$M_{xy} = M_0$$

The offset of the spin is:

$$\omega(\mathbf{r}, t) = \gamma \mathbf{G}(t) \cdot \mathbf{r}$$

The offset varies from position to position because of the gradient. It also changes as a function of time, because the gradient itself is varied (we vary it). Suppose that at some time, the spins'  $xy$  magnetization is

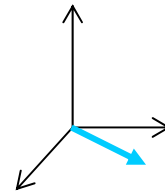

If we look at a short enough time interval,  $\Delta t$ , we can say  $\Delta\omega$  is constant in time. During the time  $\Delta t$ , the spin will precess and change its phase:

$$\Delta\phi = -\omega(\mathbf{r}, t) \times \Delta t$$

(the minus sign is there because rotations are left-handed).

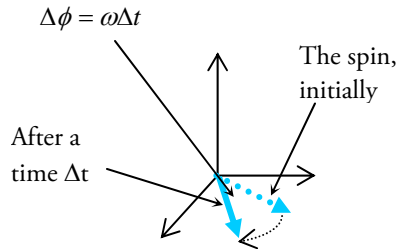

For a finite amount of time  $t$ , we'll need to sum these contributions up. The phase of the spin after a time  $t$  will therefore be:

$$\begin{aligned} \phi(t) = & -\omega(\mathbf{r}, 0)\Delta t \\ & -\omega(\mathbf{r}, \Delta t)\Delta t \\ & -\omega(\mathbf{r}, 2\Delta t)\Delta t \\ & \dots \end{aligned}$$

As  $\Delta t$  becomes smaller and smaller, this turns into an integration:

$$\phi(t) = -\int_0^t \omega(\mathbf{r}, t') dt'$$

Substituting  $\omega = \gamma\mathbf{G}(t) \cdot \mathbf{r}$  explicitly, we get:

$$\phi(t) = -\left( \gamma \int_0^t \mathbf{G}(t') dt' \right) \cdot \mathbf{r} = -\mathbf{k}(t) \cdot \mathbf{r}$$

where I took  $\mathbf{r}$  out of the integration because it is a constant (the integration is over time, not space). Hence, the spin's magnetization will be:

$$M_{xy}(t) = M_0 e^{i\phi(t)} = M_0 e^{-i\mathbf{k}(t) \cdot \mathbf{r}}$$

For a sample where the magnetization  $M_0(\mathbf{r})$  varies as a function of position, so will  $M_{xy}$ :

$$M_{xy}(\mathbf{r}, t) = M_0(\mathbf{r}) e^{-i\mathbf{k}(t) \cdot \mathbf{r}}$$

As pointed out in the above discussion, true for a single spin at a particular location  $\mathbf{r}$ , can be repeated for an arbitrary sample with an arbitrary initial distribution of spins,  $M_0(\mathbf{r})$ .

The (complex) signal is,

$$\begin{aligned} s(t) & \propto \int_{\text{object}} M_{xy}(\mathbf{r}, t) d\mathbf{r} \\ & = \int_{-\infty}^{\infty} \int_{-\infty}^{\infty} \int_{-\infty}^{\infty} M_0(\mathbf{r}) e^{-i\mathbf{k}(t) \cdot \mathbf{r}} dx dy dz \end{aligned}$$

Note that the time,  $t$ , enters only through  $\mathbf{k}$ , so we should really think of our signal as being a function of  $\mathbf{k}$ , which is a function of  $t$ :

$$s(\mathbf{k}(t)) \propto \int_{-\infty}^{\infty} \int_{-\infty}^{\infty} \int_{-\infty}^{\infty} M_0(\mathbf{r}) e^{-i\mathbf{k}(t) \cdot \mathbf{r}} dx dy dz$$

If the above looks familiar, it's because you've encountered it in lecture 5: it is the Fourier transform of  $M_0(\mathbf{r})$ , which is proportional to the density of spins at each position, which is the "image" we're after. Thus:

$$s(\mathbf{k}(t)) \propto \text{Fourier Transform}[M_0(\mathbf{r})]$$

The signal  $s(\mathbf{k})$  can be thought of as being acquired in "k-space" (or, in the 2D case, in the "k-plane").

## 2. ECHO PLANAR IMAGING (EPI)

### 2.1 THE PULSE SEQUENCE

Let's give an example of an acquisition method which will help make the above discussion clearer. This protocol is known as 2D EPI (Echo Planar Imaging), first demonstrated by Peter Mansfield, who got the 2003 Nobel prize from Medicine for his contributions to MRI alongside Paul Lauterbur. For simplicity we're going to confine ourselves to the 2D case (the object is two dimensional,  $M_0(\mathbf{r})=M_0(x,y)$ , and the "k-space" is two-dimensional,  $k_x-k_y$ ).

Below is the "pulse sequence" of EPI. A pulse sequence is simply a shorthand notation for the RF

pulses, gradients and acquisition periods used throughout an experiment:

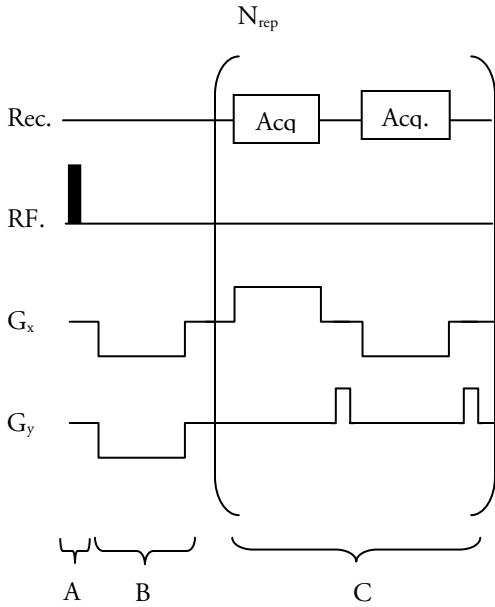

Here is a rundown of the sequence:

- A** The spins are all excited onto the xy-plane. Don't forget we're assuming a 2D object.
- B** Negative x & y gradients are applied. This has the effect of moving  $\mathbf{k}$  from its initial position,  $\mathbf{k}(0) = \gamma \int_0^0 \mathbf{G}(t') dt' = 0$ , at the center of k-plane, to the point (B) in the diagram below.
- C** Here is the "meat" of the sequence. The block (C) is repeated  $N_{rep}$  times. Each block corresponds to a "right-up-left-up" trajectory in the k-plane (as shown in the schematic illustration below). The short, strong y-gradients are said to be "blipped". One acquires when then x-gradient is on. Because the hardware isn't perfect, you can only acquire a point every so-and-so microseconds (usually on the order of 1 microseconds). The acquired points are represented by red dots along the trajectory in the schematic drawing below.

The trajectory traced out by  $\mathbf{k}(t)$  is illustrated in the  $k_x$ - $k_y$  plane below:

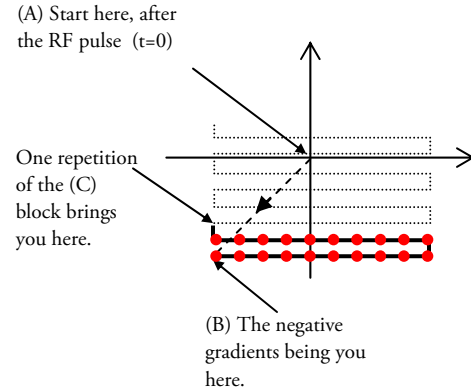

As an example, consider the following imaged (2D) object:



Its Fourier transform (the log magnitude of it, actually) was said to look like this (in chapter 5):

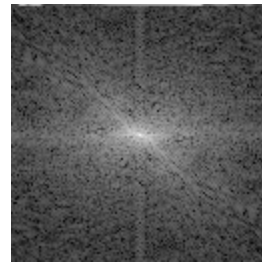

What EPI does is sample this in a rectangular grid:

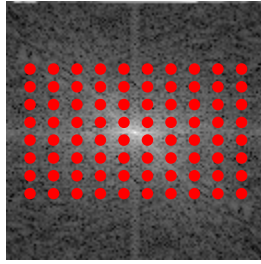

Having sampled the FT on this discrete grid, “all you need to do” is perform an inverse Fourier transform to retrieve your image (the woman with the hat<sup>1</sup>). There are, however, a few catches:

1. Technically, you’re only measuring the FT on a discrete grid (the red dots), having a finite number of points. Ideally, you’d like to know it at each and every point. This discreteness will lead to artifacts when doing the inverse FT.
2. The signal decays as you measure, according to  $T_2^*$ . This also distorts the restored image.
3. EPI has other disadvantages, as detailed below.

We’ll deal with those “catches” in subsequent chapters.

## 2.2 EPI VARIANTS

EPI has many variants, some of which we’ll get to explore later on in the course, hopefully. In general, the rectilinear trajectory shown above is not the only way of doing EPI. In fact, the short, strong “blipped” y-gradients are often hard to achieve in practice due to hardware limitations. Other trajectories in k-space have been proposed and are routinely used. For example, spiral EPI:

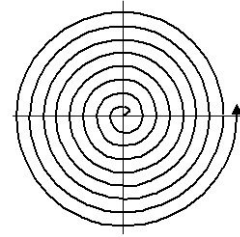

The different trajectories have different advantages. For example, the spiral trajectory above is easier on the gradients. It is also less susceptible to inhomogeneity artifacts (see 2.3 below). It is, however, more tricky to reconstruct the original image because of the irregular sampling (which isn’t on a rectilinear grid anymore).

The ideas behind all EPI-based methods are the same:

1. Excite the spins.
2. Start moving around in k-space by varying the gradients, and acquire.

## 2.3 ADVANTAGES/DISADVANTAGES OF EPI

Advantages:

- Fast: just about the fastest scan technique there is. You can acquire an entire 2D image in a few tens of milliseconds. An entire 3D image of the brain can be had in a few seconds.
- Low RF power deposition: The use of a single 90 pulse to excite the spins means the patients don’t get irradiated a lot. Irradiation can be problematic since it can cause the tissues in the body to heat up.
- Because the technique is fast, it is also pretty robust with respect to motion. You don’t see a lot of motion artifacts (originating from breathing, heart beats, etc).

Disadvantages:

- Puts high demands on the gradients. This isn’t just a technical problem.

<sup>1</sup> “The woman with the hat” is actually Lena Soderberg, a Swedish Playboy model. This cover picture of her from 1972 “somehow” became the de-facto standard in computer science when comparing image processing algorithms.

The rapidly varying gradients can cause biophysical effects in patients, such as electrical currents in tissues.

- Sensitive to gradient imperfections (and there are imperfections. Lots).
- Resolution is just so-so compared to other scan techniques.
- Signal decays as  $T_2^*$ . Other scan techniques can make the signal decay slower, according to  $T_2$ . This decay also means that ...
- ... EPI is particularly susceptible to magnetic field inhomogeneities. In particular, in the brain, there are a few notorious areas which are hard-to-impossible to observe with EPI: the area near the frontal and temporal lobes:

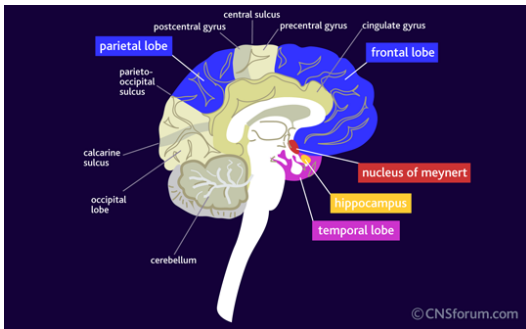

### 3. RESOLUTION

The fact that the FT of the image is sampled at only a discrete number of points means the reconstruction of the image will not be perfect:

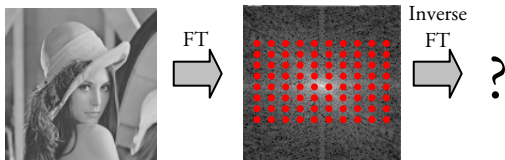

We will now argue two things:

1. The discreteness of the grid will lead to the main image being duplicated infinitely in all directions. The

“original”, “main” image and its duplicates will be spaced apart in inverse proportion to the spacing in k-space: the denser the grid, the more spaced-apart the duplicates. If the points in k-space will be too far apart, the duplicates will end up overlapping with the “main” image and botch it up. This is called **aliasing**.

2. The finite extent of the grid will cause a basic blurring in the image, which will be greater the smaller the grid.

### 3.1 BLURRING

We now turn to hand-wave our way through these two arguments. To make things easier to visualize, we’ll deal with the 1D case, and finally remark something about the 2D case. The Fourier transform of the function  $\cos(\omega t)$  is a very sharp peak (a “delta function”, to be mathematically precise, but never mind the exact name):

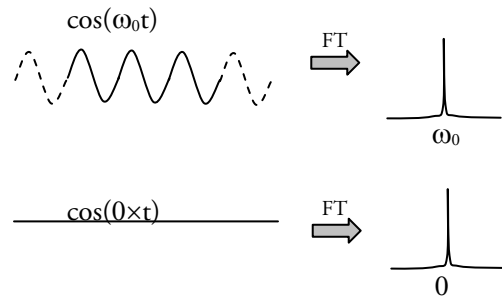

We’ve seen, however, that:

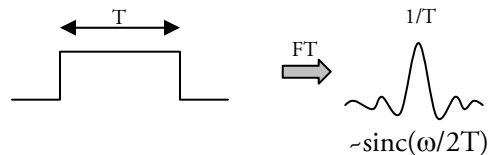

i.e., by “cutting off” the constant function  $\cos(0 \times t) = 1$  at the edges, effectively turning it into a “box” of width  $T$ , we end up widening the sharp peak and turning it into a sinc function. Thus:

Truncating the sampled function at a width  $T$ , causes sharp features to widen (“blur”) to a width  $1/T$ .

In terms of images, a sharp point in the image at  $f(x,y)$  will get blurred by an amount proportional to  $k_{\max,x}$  in the x-direction and  $k_{\max,y}$  in the y-direction:

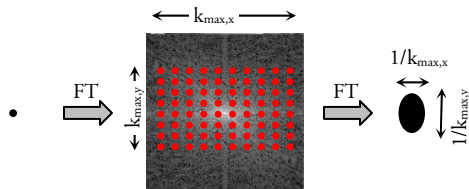

Left: initial object to be imaged is sharp. Middle: sampled k-space (schematic drawing). Right: Fourier-transforming the sampled k-space data points results in widened peak.

**haven't** seen yet. For example, I haven't said anything about how we can we get  $T_1$  and  $T_2$  maps. There are also plenty of other sources of **contrast** left to be explored in MRI. Examples: blood flow, brain metabolites, random motion (diffusion) and much more. This above reasoning only reveals how to uncover  $M_0(\mathbf{r})$ . We still have a ways to go before we can get to those. It's not time to kick and back relax just yet!

### 3.2 ALIASING

s

## 4. THE END?

A naive assumption at this point would be that this is it: we're done. If it's an image we're after, we have all the machinery in place. We know (i.) how to sample different points in k-space, by acquiring while varying and gradients, and (ii.) how to Fourier transform backwards and obtain the image,  $M_0(\mathbf{r})$ . Why not stop here? There are two answers to that:

1. Practical: in reality, human patients are not ideal imaging subjects. They get impatient after 30-40 minutes in an MRI scanner. They breath. They move. They have blood flowing through them. They have susceptibility artifacts. In short: a real MRI experiment poses many difficulties which still need to be addressed. How can we get the highest resolution, in the least amount of time, with the fewest artifacts? This comprises a large portion of MRI research.
2. Fundamental: who said it's  $M_0(\mathbf{r})$  (the water density) we're after? There are lots of things you can see with MRI which we